

# Global EV Outlook 2026

Growing sales amid an energy crisis

International  
Energy Agency



# INTERNATIONAL ENERGY AGENCY

The IEA examines the full spectrum of energy issues including oil, gas and coal supply and demand, renewable energy technologies, electricity markets, energy efficiency, access to energy, demand side management and much more. Through its work, the IEA advocates policies that will enhance the reliability, affordability and sustainability of energy in its 32 Member countries, 13 Association countries and beyond.

This publication, as well as any data and map included herein, are without prejudice to the status of or sovereignty over any territory, to the delimitation of international frontiers and boundaries and to the name of any territory, city or area.

Revised version, May 2026  
Information notice found at:  
[www.iea.org/corrections](http://www.iea.org/corrections)

Source: IEA.  
International Energy Agency  
Website: [www.iea.org](http://www.iea.org)

## IEA Member countries:

Australia  
Austria  
Belgium  
Canada  
Czech Republic  
Denmark  
Estonia  
Finland  
France  
Germany  
Greece  
Hungary  
Ireland  
Italy  
Japan  
Korea  
Latvia  
Lithuania  
Luxembourg  
Mexico  
Netherlands  
New Zealand  
Norway  
Poland  
Portugal  
Slovak Republic  
Spain  
Sweden  
Switzerland  
Republic of Türkiye  
United Kingdom  
United States

The European Commission also participates in the work of the IEA

## IEA Accession countries:

Brazil  
Chile  
Colombia  
Costa Rica  
Israel  
Romania

## IEA Association countries:

Argentina  
China  
Egypt  
India  
Indonesia  
Kenya  
Morocco  
Senegal  
Singapore  
South Africa  
Thailand  
Ukraine  
Viet Nam



# Abstract

The *Global EV Outlook* is an annual publication that identifies and assesses recent developments in electric mobility across the globe.

Combining analysis of historical data with projections, the report examines key areas of interest, such as the deployment of electric vehicles and charging infrastructure, battery demand, and key policy developments in major and emerging markets. It also considers the implications of growing EV adoption for electricity and oil consumption, as well as greenhouse gas emissions.

Amid the ongoing energy crisis sparked by the conflict in the Middle East, this edition includes early monthly data for 2026 and considers potential implications of the crisis for policy and market development. It also includes analysis of the affordability of electric cars and the manufacturing and trade of electric cars, trucks and their batteries, along with a special chapter on automotive technology trends related to software and artificial intelligence.

The report is complemented by updated versions of two online tools: the Global EV Data Explorer – which now includes vehicle price data in selected markets – and the Global EV Policy Explorer. These tools allow users to interactively explore EV statistics, projections and policy measures worldwide.

The report is developed with the support of members of the Electric Vehicles Initiative (EVI); the United Nations Environment Programme also supported the expansion of this year's Policy Explorer.

# Acknowledgements, contributors and credits

The *Global EV Outlook 2026* was prepared by the Energy Technology Policy (ETP) Division of the Directorate of Sustainability, Technology and Outlooks (STO) of the International Energy Agency (IEA). The project was designed and directed by Timur Gül, Chief Energy Technology Officer. Araceli Fernandez Pales, Head of the Technology Innovation Unit, provided strategic guidance throughout the development of the project. Elizabeth Connelly co-ordinated the analysis and production of the report.

The principal IEA authors were (in alphabetical order): Oskaras Alšauskas, Giovanni Andrean, Jannik Braun, Joseph Donovan, Hannes Gauch, Mathilde Huismans, YuJin Jeong, Teo Lombardo, Vera O’Riordan, Apostolos Petropoulos and Jules Sery. Leonardo Paoli contributed to the uncertainty analysis related to the energy crisis. Caroline Robert contributed to the analysis of financial implications of delays in the construction and opening of electric vehicle charging stations. Leonardo Collina contributed to the analysis of the implications of the EU Automotive Package proposal on “low-carbon” steel demand. Michael Drtil contributed to the analysis on grid upgrade costs. Ottavia Valentini contributed to the analysis of regulatory and market readiness for operationalising vehicle-to-grid capabilities. Eric Buisson and Shobhan Dhir contributed to the analysis on mining needs and critical mineral availability for electric vehicle demand. Celeste del Vecchio, Tiffanie Laborie-Bousquet, Rebecca McKimm, Keishi Takada and Ivo Walinga contributed to the research on EV supportive policies and automaker electrification plans. Alexandre Gouy, Axel Norden Fördös, Julien Radet and Andrew Ruttinger provided targeted support to the project.

Valuable insights and feedback were provided by senior management and other colleagues from across IEA, including Laura Cozzi, Tim Gould, Dan Dorner, Toril Bosoni, Dennis Hesseling, Brian Motherway, Alessandro Blasi, Thomas Spencer, Stéphanie Bouckaert, Hugh Hopewell, Shobhan Dhir, Shane McDonagh, Anthony Vautrin and Jacques Warichet. Per-Anders Widell, Charlotte Bracke and Bérengère Merlo provided essential support throughout the process. Olivia Napper supported figure design. Lizzie Sayer edited the manuscript.

Special thanks go to Prof. Andreas Ulbig and his team at RWTH Aachen University (Andreas Bong and Julian Bigalke) for their analytical input on the flexibility potential of different grid-connected technologies.

Thanks go to the IEA's Communications and Digital Office, particularly to Jethro Mullen, Lee Bailey, Isabella Batten, Curtis Brainard, Poeli Bojorquez, Gaelle Bruneau, Jon Custer, Astrid Dumond, Merve Erdil, Grace Gordon, Julia Horowitz, Oliver Joy, Isabelle Nonain-Semelin, Andrea Pronzati, Robert Stone, Sam Tarling, Clara Vallois, Lucile Wall, Wonjik Yang.

The work could not have been achieved without the financial support provided by the governments of Canada, Japan, the Netherlands and Sweden (as part of their contribution to the CEM Electric Vehicles Initiative) and the funds received through the Global E-Mobility Programme funded by the Global Environment Facility (GEF).

The report benefited from the high-calibre data and support provided by the following colleagues: Somayyah Alyammahi (Ministry of Energy and Infrastructure, United Arab Emirates); Jón Ásgeir Haukdal Porvaldsson (Icelandic Environment and Energy Agency); Adrian Bereda (Ministry of Climate and Environment, Poland); Abdul Hakim Bin Ab Rahim (Malaysian Green Technology Climate Change Corporation); Klaas Burgdorf (Swedish Energy Agency); Georgina Campbell (Energy Efficiency & Conservation Authority, New Zealand); Luca Castiglioni (Swiss Federal Office of Energy); Isabel del Olmo Flórez (Institute for Diversification and Saving of Energy, Spain); Theresa Faustino (Bureau of Policy Research and Innovation, Philippines); Sigurður Friðleifsson (Icelandic Environment and Energy Agency); Camille Gautier (Ministry of Ecological Transition, France); Roger Lee (Department of Climate Change, Energy, the Environment and Water, Australia); Leticia Lorentz (Energy Research Company, Brazil); Karl Lyndon Pacolor (Bureau of Policy Research and Innovation, Philippines); Nabil Mneimne (United Nations Development Programme); Edwin Oswaldo Alvarado Mancía (General Directorate of Energy, Hydrocarbons and Mines, El Salvador); Marko Paakinen (VTT Technical Research Centre of Finland); Hiten Parmar (The Electric Mission, South Africa); Nissa Paul-Alexander (Department of Sustainable Development, Saint Lucia); Xiaorong Qiao (Transport Canada); Sophie Rammerstorfer (AustriaTech); Toke Rueskov Madsen (Danish Energy Agency); Daniela Rodríguez Celis (Ministry of Energy, Chile); Daniel Thorsell (Norwegian Public Roads Administration); Julio Vassallo (Ministry of Environment and Sustainable Development, Argentina); Britt Woltermann (Netherlands Enterprise Agency); Arisa Yonezawa (Ministry of Economy, Trade and Industry, Japan); Joann Zhou (Argonne National Laboratory, United States).

The following peer reviewers provided essential feedback to improve the quality of the report: Sam Adham (CRU); Ali Adim (S&P Global Mobility); Appurva Appan and Juan Camilo Ramírez Arjona (Ricardo AEA); Keonwoo Bae (Hyundai); Edgar Barassa (Barassa & Cruz Consulting); Harmeet Bawa (Hitachi Energy); Georg Bieker (International Council on Clean Transportation); Tomoko Blech (CHAdEMO); Giorgios Bonias (Shell); Johan Bracht (McKinsey); Baerte de Brey

(Elaad); Luca Castiglioni (Federal Energy Office, Switzerland); Richard de Caux (BP); Pierpaolo Cazzola (University of California, Davis); Michael Clarke (eTrucker App); François Cuenot (UNECE); Ilka von Dalwigk (Recharge); Polash Das (United Nations Environment Programme); Laurent Demilie (Ministry of Transport, Belgium); Albert Dessi (Department of Climate Change, Energy, the Environment and Water, Australia); Michael Dwyer (US Energy Information Administration); Bert Fabian (ADB); Tom Fairlie (Cobalt Institute); Hiroyuki Fukui (Toyota); Lewis Fulton (UC Davis); Sebastian Galarza (Center for Sustainable Mobility); Camille Gautier (Ministry of Ecological Transition, France); Yoann Gimbert (Transport & Environment); Victoria Guimier (TotalEnergies); Johnathan Harris (Exxon Mobil); Aaron Hoskin (Transport Canada); Anders Hove (Oxford Institute for Energy Studies); Antonio Iliceto (Terna Rete Italia); Patrick Jochem (German Aerospace Center); Rachmat Kaimuddin (Coordinating Ministry of Infrastructure and Regional Development, Indonesia); Tarek Keskes (World Bank); Neil King (EV Volumes); Akiko Kishiue (World Bank); Alex Koerner (UNEP); Andreas Kopf (International Transport Forum); Bahtiyar Kurt (UNDP); Yossapong Laoonual (King Mongkut's University of Technology Thonburi (KMUTT)); Francisco Laveron (Iberdrola); Yangchao Li (World Bank); Pieter Looijestijn (Ministry of Infrastructure and Water Management, the Netherlands); Leticia Lorentz (EPE Brazil); Wang Lü (China Automotive Technology and Research Center (CATARC)); Owen MacDonnell (CALSTART); Vittorio Manente (Aramco Europe); Hans Eric Mellin (Circular Energy Storage); Nabil Mneimne (UNDP, Lebanon); Gian Montoya (Empresas Públicas de Medellín); Matteo Muratori (Pacific Northwest National Laboratory); Rachael Nealer (Atlas Public Policy); Bessie Noll (ETH Zürich); Motoko Ogawa (Ministry of Economy, Trade and Industry, Japan); Mario Ortiz (independent); Sara Pasquier (Fastned); Marco Piffaretti (EV TCP Task 53); Karl Piskorek (BMW); Robert Price (EV Volumes); Cristian Prokop (BASF); Davide Puglielli (Enel); Abdelilah Rochd (IRESEN Morocco); Urs Ruth (Bosch); Emanuela Sartori (Enel X); Sacha Scheffer (Independent); Wülf-Peter Schmidt (Independent); Elisabeth Schrefl (Department of Climate Change, Energy, the Environment and Water, Australia); Arjit Sen (ICCT); Urska Skrt (WBCSD); Joseph Teja (CALSTART); Jacob Teter (independent); Levi Tillemann (S&P Global); Lyle Trytten (independent); Ulderico Ulissi (ZERO Institute – University of Oxford); Francesco Vellucci (ENEA); Sheila Watson (FIA Foundation); Israel Woldemariam Biramo (World Bank); Amber Woodward (Centre for Net Zero); Nodir Xudayberdiyev (Ministry of Transport, Uzbekistan); Lulu Xue (WRI); Arisa Yonezawa (Ministry of Economy, Trade and Industry, Japan); Yubo Zhai (NewLink); Uwe Zimmer (Infineum); Liu ZiYu (CATL).

# Table of contents

<b>Electric Vehicles Initiative</b> .....	<b>9</b>
<b>Executive summary</b> .....	<b>10</b>
<b>Chapter 1. Trends in electric car markets</b> .....	<b>16</b>
Electric car sales .....	16
Model availability and range.....	32
2026 sales trends.....	41
<b>Chapter 2. Trends in electric car prices</b> .....	<b>48</b>
New electric car prices .....	48
Resale value of used electric cars.....	59
Government support for electric car sales.....	63
<b>Chapter 3. Trends in other light-duty electric vehicles</b> .....	<b>69</b>
Electric two- and three-wheelers .....	69
Electric light commercial vehicles.....	73
<b>Chapter 4. Trends in heavy-duty electric vehicles</b> .....	<b>77</b>
Trends in electric bus sales.....	77
Trends in electric truck sales .....	79
Electric heavy-duty model availability.....	87
<b>Chapter 5. Trends in electric vehicle batteries</b> .....	<b>92</b>
Electric vehicle battery deployment.....	92
Battery industry trends .....	93
Emerging battery chemistry and designs .....	100
<b>Chapter 6. Trends in electric vehicle charging</b> .....	<b>104</b>
Light-duty electric vehicle charger deployment.....	104
Heavy-duty vehicle charger deployment .....	117
Alternative charging solutions .....	122
<b>Chapter 7. Trends in manufacturing and trade</b> .....	<b>129</b>
Manufacturing and trade of electric cars .....	129
Manufacturing and trade of electric trucks.....	139
Battery manufacturing and trade .....	143
Electric vehicle supply equipment manufacturing.....	151
<b>Chapter 8. Technology trends</b> .....	<b>157</b>
Overview .....	157
Vehicle software and software-defined vehicles.....	159
Autonomous vehicles .....	163

Artificial intelligence and EVs .....	169
Security considerations for connected and autonomous vehicles .....	171
Ultra-fast charging batteries .....	173
Vehicle-to-grid technology .....	176
<b>Chapter 9. EV and battery outlook .....</b>	<b>190</b>
Scenario overview .....	190
Vehicle outlook by mode .....	191
Vehicle outlook by region .....	195
Carmaker electrification announcements .....	214
EV battery demand outlook .....	220
Battery recycling .....	223
Special focus: Manufacturing and trade outlook for electric cars and batteries .....	228
<b>Chapter 10. Charging outlook.....</b>	<b>237</b>
Projecting charging needs .....	237
Light-duty vehicle charging.....	237
Heavy-duty vehicle charging .....	245
Charging investments.....	248
<b>Chapter 11. Implications of the EV outlook.....</b>	<b>257</b>
Implications for the energy system .....	257
Electricity demand .....	257
Oil displacement.....	259
Fuel tax revenue implications .....	260
Emissions impacts.....	262
<b>Annexes.....</b>	<b>267</b>
Annex A: Oil displacement from electric vehicles .....	267
Annex B: Definition of car size segment.....	270
Annex C: Battery-related assumptions and methodological notes .....	271
Annex D: Total cost of ownership analysis for trucks .....	274
Annex E: Costs and financial assumptions for home charging and gasoline refuelling .....	277
Annex F: Battery swapping station assumptions .....	282
Annex G: Automaker electrification targets .....	284
Annex H: Estimating flexibility potentials for V2G .....	287
Annex I: Glossary .....	288

# Electric Vehicles Initiative

The Electric Vehicles Initiative (EVI) is a multi-governmental policy forum established in 2010 under the Clean Energy Ministerial (CEM). Recognising the opportunities offered by EVs, the EVI is dedicated to accelerating the adoption of EVs worldwide. To do so, it strives to better understand the policy challenges related to electric mobility, to help governments address them and to serve as a platform for knowledge-sharing among government policy makers. The EVI also facilitates exchanges between government policy makers and a variety of other partners on topics important for the transition to electric mobility, such as charging infrastructure and grid integration as well as EV battery supply chains.

The International Energy Agency serves as the co-ordinator of the initiative. Governments that have been active in the EVI in the 2025-26 period include Canada, People's Republic of China (hereafter "China"), Finland, France, Germany, India, Japan, the Netherlands, New Zealand, Norway, Poland, Portugal, Sweden, United Kingdom and United States.

The Global EV Outlook annual series is the flagship publication of the EVI. It is dedicated to tracking and monitoring the progress of electric mobility worldwide and to informing policy makers on how to best accelerate electrification of the road transport sector.



# Executive summary

## After another record year for EV sales, attention is turning to the impacts of the energy crisis for global car markets

**Electric car sales grew by 20% globally to exceed 20 million in 2025, meaning one-quarter of all new cars sold were electric.** Europe saw the strongest growth among major electric vehicle (EV) markets, with electric car sales rising by more than 30% to reach 28% of total sales, following an increase in the stringency of the European Union's CO<sub>2</sub> standards for cars. China's growth in electric car sales slowed slightly, in part due to a temporary halt to its trade-in scheme, but EVs still accounted for nearly 55% of all car sales. In the United States, electric car sales remained relatively stable at just under 10% of car sales, though the end of EV tax credits coincided with a drop in sales at the end of the year. Meanwhile, some emerging markets saw steep increases in electric car sales. In Southeast Asia, annual sales more than doubled to reach a sales share of nearly 20%, led by Viet Nam, Indonesia and Thailand. In Latin America, sales grew by 75%, led by Brazil and Mexico. More than 100 countries recorded electric car sales growth in 2025, and in one-third of these, they represented at least 10% of new car sales. Chinese automakers supplied 60% of global electric car sales in 2025, while European and North American automakers were each responsible for about 15% of global sales.

**The ongoing energy crisis resulting from the conflict in the Middle East has brought reliance on oil imports into sharp focus in many countries.** The road transport sector represents close to half of oil demand today, and policy responses to the long tail of the current crisis stand to shape the global car market for years to come. The oil crisis of the 1970s prompted the introduction of fuel efficiency standards, which resulted in close to a doubling of the fuel economy of conventional cars between 1975 and today, while during the Covid-19 pandemic, many countries introduced EV subsidies to boost uptake and support a broader economic recovery. In 2025, the global fleet of EVs avoided the consumption of around 1.7 million barrels of oil per day (mb/d), primarily in countries that have implemented fuel economy and CO<sub>2</sub> standards, such as China and the European Union. Some countries in Southeast Asia – including Viet Nam, the largest EV market in the region – have already announced plans to expand or extend EV tax incentives as part of their response to the current energy crisis.

## Electric cars are poised to make up a greater share of total car sales in 2026

**The current high oil price environment is drawing consumer attention to the economic benefits of driving EVs.** Electric cars generally have lower running costs than internal combustion engine (ICE) vehicles, mainly due to their higher efficiency. The recent rise in oil prices resulting from the conflict in the Middle East has further increased the cost savings associated with driving an EV. For example, based on average oil prices in April, the annual fuel cost savings associated with driving an EV in the European Union grew 35% compared to 2025 savings. For corporate fleets that travel long distances, the running cost savings can be several times larger than for the general consumer. Preliminary signs suggest EV sales are increasing in countries with supply concerns, or where fuel price increases have been particularly steep. However, the full implications of the current crisis will take time to register in the car market, due in part to the lag between vehicle orders and deliveries. For consumers in emerging economies with low rates of motorisation and high sensitivity to fuel prices, electric two- and three-wheelers look to be an attractive option – sales more than doubled year-on-year in the first quarter of 2026 in Southeast Asia, and grew more than 30% in India.

**Electric car sales broke records in a number of markets during the first quarter of 2026.** Global sales, at around 3.9 million, were 8% lower than over the same period last year, primarily because of lower sales in China and the United States following key policy changes. However, this overall decline masks strong sales growth in many countries: in Europe, sales were up close to 30% year-on-year; countries in Asia Pacific excluding China saw year-on-year sales growth of 80%, and sales across Latin America were up by 75%. In March 2026, around 30 countries saw record-breaking monthly sales, and a further 60 countries recorded year-on-year sales growth. Preliminary April data shows that monthly electric car sales in China grew to a record high of over 60% of total car sales, even if year-to-date electric car sales remained lower than in 2025.

**Global electric car sales are expected to grow to 23 million in 2026, representing 28% of total car sales.** Europe is poised for the largest growth among major markets, with sales projected to increase by around 20% in 2026, such that one in three cars sold are electric. In China, electric car sales are set to grow across 2026, albeit at a slower rate than in previous years, to reach almost 60% of total car sales. Sales across Asia Pacific countries other than China are expected to grow by over 50%, while sales in Latin America are projected to rise by 45%. The wider economic impacts of the conflict in the Middle East might temper overall car sales. In many regions, however, there is upside potential to the 2026 EV forecast depending, in part, on how, when and which policies are enacted amid the current energy crisis.

## Policies and affordability will continue to shape the EV outlook in key markets

**Even without any new policy announcements, the global fleet of EVs is projected to grow more than sixfold by 2035 from 2025 levels, to reach as many as 510 million, without counting electric two- or three-wheelers.** The increasing cost-competitiveness of EVs, along with tighter CO<sub>2</sub> and fuel economy standards, are poised to drive market growth, pushing up the share of EVs in global car sales to around 50% in 2035 in the IEA's exploratory scenarios.<sup>1</sup> By contrast, the share of ICE cars continues to shrink in all scenarios, and sales never return to their 2017 peak. In China, 70% of battery electric cars sold in 2025 were already cheaper than the average conventional car; in China's small car segment, electric cars have already largely displaced sales of conventional cars. This price dynamic helps to push electric cars to exceed 90% of total car sales in China in 2035. In Europe, CO<sub>2</sub> standards continue to drive sales of electric cars; in 2025, car manufacturers adjusted their pricing strategies and introduced more affordable EV models to comply with the new emissions targets. Enacting the proposed Automotive Package in the European Union would reduce the 2035 outlook nonetheless, but the sales share of electric cars still exceeds 90%.

**Policies and price dynamics are poised to drive EV sales in particular in Southeast Asia, where the share of electric car sales is projected to increase by up to three times by 2035.** Imports of affordable electric cars from China have brought down prices and driven up EV sales in many emerging markets in recent years. For example, in Thailand, electric car prices have been on par with those of ICE cars for the past 2 years. In Indonesia, the average price premium for electric cars declined from over 50% in 2024 to around 40% in 2025. Some countries are looking to tighten import rules to support the development of domestic manufacturing, which may affect affordability in the future. Viet Nam is the only country in the region that has a sizeable domestic EV manufacturer offering EVs at prices comparable to those of ICE cars. As a result, Viet Nam could reach an electric car sales share of over 80%, the highest of any Southeast Asian country in 2035.

**For countries that rely on imports to meet oil demand, the energy security benefits of rising EV uptake could shape future policy choices.** China – the world's largest oil importer – is also home to the largest stock of EVs, which displaced around 1 mb/d of oil demand in 2025 and is set to displace 2.7 mb/d annually by 2030. Globally, the annual displacement of oil by EVs is on track to

---

<sup>1</sup> The IEA exploratory scenarios used in the Global EV Outlook 2026 are the Current Policies Scenario and the Stated Policies Scenario, which are based on a set of starting conditions.

triple to around 5 mb/d per day in 2030. Growing deployment of electric trucks – the second-largest oil consuming transport mode – avoids the consumption of 1 mb/d in 2035 based on current policies.

## The electrification of road transport continues apace, driven by a sharp increase in electric truck sales in China

**Electric truck sales more than doubled in 2025 compared with 2024, reaching 9% of all truck sales worldwide.** The vast majority of this growth came from China, where sales doubled for the second consecutive year in 2025; one in four trucks sold in China was electric. Electric truck sales also grew in Europe and North America, albeit at a much lower level. Electric trucks remain two to three times more expensive to purchase than diesel trucks, but the total cost of ownership (TCO) is already competitive in China thanks to falling battery prices and is coming down in other markets. In Europe, the TCO of electric trucks is expected to reach parity with that of diesel trucks by 2030. To enable electric long-distance trucking, the European Union now has over 1 000 charging points exclusively for electric trucks. Based on current policies, electric trucks are set to constitute at least 20% of global truck sales in 2035, led by sales in China, where they reach a 60% sales share.

**New electric truck producers from the machinery and heavy industry sectors are gaining market share in the growing Chinese market.** In 2025, almost 30% of the Chinese electric truck market was captured by new market entrants that do not have conventional models in their line-ups. Electric truck sales in China are almost exclusively from Chinese manufacturers with Chinese batteries (with CATL supplying 80% of the total) and truck chassis, reflecting the country's highly integrated ecosystem and strong local supplier network.

**The most electrified road transport segment of all – two- and three-wheelers – continued to grow in 2025.** While sales in China and India, the world's largest two-wheeler markets, grew only slightly in 2025 to a total of 8.4 million, sales doubled in Viet Nam, underpinning global growth. Sales also grew markedly in Africa to reach about 70 000 two-wheelers in 2025 – over 80 times more than at the start of the decade. The sales share of electric three-wheelers stood at over 25%, continuing to increase even as the overall three-wheeler market contracted.

## Trade plays an important role in the EV industry

**China remains the world's largest EV manufacturing hub, accounting for nearly 75% of electric cars produced in 2025.** Almost 22 million electric cars were produced globally in 2025 – a more than 25% increase on the previous year. Intense domestic competition in China is squeezing profit margins, pushing

manufacturers to seek higher profits overseas. Chinese electric car exports doubled to a record high of over 2.5 million in 2025, as production outstripped domestic demand. In 2024, China overtook the European Union to become the largest exporter of cars; in 2025, more than 35% of China's car exports were EVs, up from 20% in 2024. Imports from China accounted for 55% of electric car sales in 2025 in countries outside Europe and the United States, up from less than 5% just 5 years earlier. More than half of electric cars sold in Southeast Asia in 2025 were by Chinese brands, while one-third came from a Vietnamese manufacturer.

**Around one-quarter of electric cars produced in 2025 were traded between countries.** Electric car exports from the European Union grew 25% in 2025, but imports also rose by around 35% year-on-year to more than 900 000; China accounted for almost 60% of these imports. Imports to the United States fell slightly in 2025, with the largest share coming from Mexico. In the first quarter of 2026, electric car exports from China more than doubled compared with the same period in 2025, offsetting weaker domestic sales. Yet Chinese exports could face headwinds in 2026 as inventories build up: in 2025, exports are estimated to have exceeded overseas sales by more than 25%.

**China accounted for over 80% of battery cell production in 2025 and even higher shares of production of the active materials in EV batteries.** Nearly all battery cells used worldwide are supplied by companies headquartered in China, Korea or Japan, and the market share of Chinese producers is growing especially fast in the European Union, having almost doubled since 2023. However, narrow profit margins are putting pressure on some battery manufacturers, and tightening access to advanced manufacturing production tax credits in the United States could challenge Korean and Japanese battery manufacturers that are heavily exposed to the US market. Despite lithium-ion battery manufacturing capacity growing faster in the European Union and the United States than in China last year, China is set to remain the largest producer of batteries and battery materials to 2035 based on stated policies.

## Technology advances and AI are reshaping the automotive industry, led by the EV industry

**Following the lead of pure-play EV makers, most major automakers are developing vehicles with more centralised software systems that allow key functions and systems to be updated remotely.** Battery electric vehicles are currently the most advanced of these “software-defined vehicles” (SDVs), which rely on more centralised control architectures and enable a wide range of vehicle developments, supported by falling prices for sensors, more powerful computing chips and the use of artificial intelligence. Advanced driver assistance systems (such as automated steering and speed control) as well as EV battery management improvements are key applications. The use of autonomous

vehicles is also accelerating, with driverless taxis – all of them electric – now operating commercially in more than 20 cities, mainly in China and the United States. However, with new technologies come new challenges: the greater number of semiconductors needed to support increasingly digital and autonomous vehicles means increasing reliance on supply chains that are already geographically concentrated. Further, managing cybersecurity risks will become increasingly important for automakers.

**Technological advances are improving EV charging times and creating opportunities to reduce peak demand on the grid.** New power-electronics materials, battery cell technologies and battery pack architectures are enabling charging systems that are more efficient, higher voltage – and therefore faster. The first 1 000-volt models came out in 2025, and announcements of charging times of under 10 minutes have continued into 2026. The number of electric cars able to use chargers above 250 kW represents less than 5% of the vehicle stock, but sales are growing alongside the expansion of ultra-fast and megawatt-scale chargers. As EV deployment and charging speeds increase, grid capacity constraints could become more pronounced in some regions. With no change to current policies, electricity demand from EVs could exceed 1 500 TWh by 2035 – growing around sixfold from 2025 levels. While impressive, this would increase total global electricity demand in 2035 by only about 4%. The impacts vary by region: across Europe, EV deployment in road transport increases total electricity demand by more than 10% in 2035, compared with an increase of under 6% in China. Measures such as smart charging, which reduces peak demand by shifting charging loads, or vehicle-to-grid (V2G) – which allows EVs to feed electricity back to the grid – can offer additional flexibility. The first commercial offers for V2G for private EV owners appeared in 2025, although there are few V2G-capable models available, the regulatory landscape for V2G remains fragmented, and standards are not yet clear. Battery innovation is likely to continue: patents related to batteries account for nearly half of all energy-sector patents.

# Chapter 1. Trends in electric car markets

## Electric car sales

### Electric car sales topped 20 million globally in 2025

#### One in four new cars sold worldwide was electric in 2025

The electric car market reached new highs in 2025, growing by 20% from 2024 to exceed 20 million sales, in line with expectations in the 2025 edition of the *Global EV Outlook*.<sup>2</sup> The sales share of electric cars in the overall car market increased to 25%. This marked the fifth consecutive year in which annual electric car sales increased by about 3.5 million, a trend that began in 2021 after the Covid-19 pandemic. As a result, about 5% of the global car stock is now electrified, displacing 1.2 million barrels of oil per day in 2025 (see [Annex A](#)).

**Figure 1.1 Electric car sales globally and sales share for selected regions, 2020-2025**

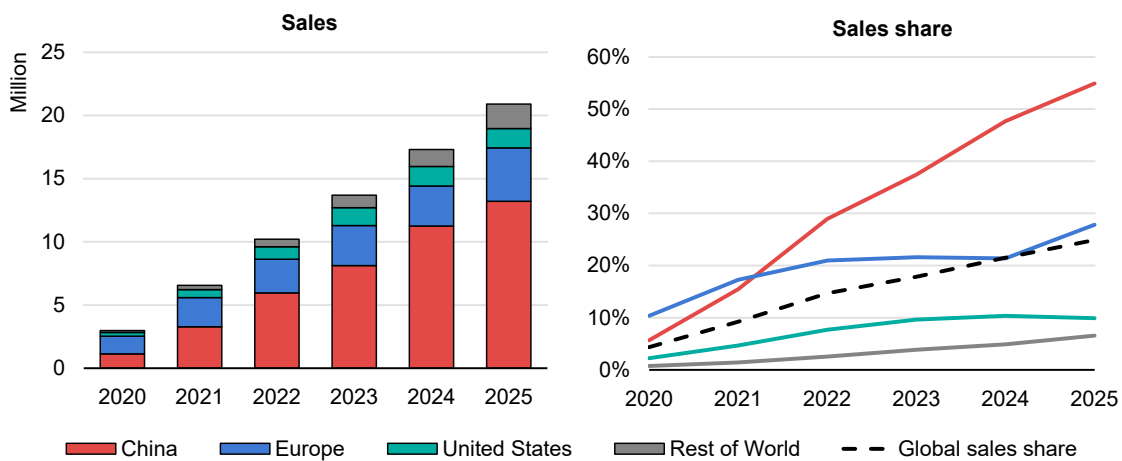

IEA. CC BY 4.0.

Note: Electric cars include battery electric and plug-in hybrid electric cars.

Sources: IEA analysis based on [EV Volumes](#), [ACEA](#), [EAFO](#) and country submissions.

<sup>2</sup> In this report “sales” represents an estimate of the number of new vehicles hitting the roads. Where possible, data on new vehicle registrations is used. In some cases, only data on retail sales are available. New car sales or registrations exclude used cars. Unless otherwise specified, the term electric vehicle is used to refer to both battery electric and plug-in hybrid electric vehicles (PHEVs) but does not include fuel cell electric vehicles (FCEVs).

In particular, 2025 saw a boost for battery electric cars. The share of battery electric cars in total electric car sales increased to 65%, reversing the trend seen in the 2 years prior. While 2024 saw a strong increase in extended-range electric vehicles (EREVs), this did not continue in 2025, dropping to less than 7% of total electric car sales, after rising to 7.5% in 2024.<sup>3</sup>

Market developments varied across regions. In the People's Republic of China (hereafter, "China"), growth slowed slightly partly as a result of its trade-in scheme being temporary halted, but the country still accounted for more than half of the global increase in electric car sales in 2025. Europe experienced an upswing in sales following a step change in the EU CO<sub>2</sub> standards, with sales rising 30% to more than 4 million after having stagnated in 2024. In the United States, the sales share of electric cars remained relatively stable at just below 10%, despite several policy shifts, including the ending of tax credits, which resulted in sales falling significantly in the last quarter of the year. Meanwhile, outside of these major car markets, sales continued to expand rapidly.

In a growing number of countries, the electric car sales share has recently surpassed 10%, and in some cases, progress has been even faster than in the three largest EV markets. Some later-entry markets have seen rapid increases in electric car sales, thanks to the economies of scale and cost-competitiveness of Chinese-made electric cars. For example, Nepal has witnessed one of the largest increases in electric car sales shares since 2020, as imports of electric cars made in China increased significantly. More than half of the 2 million electric car sales outside of the three major markets in 2025 took place in countries across Latin America, the Asia Pacific and the Middle East that have now reached an electric car sales share of more than 10%.

---

<sup>3</sup> If not otherwise specified, plug-in hybrid electric vehicles (PHEVs) include EREVs. EREVs are a subset of PHEVs that have both an internal combustion engine (ICE) and a plug-in rechargeable battery.

**Figure 1.2 Electric car sales share in selected countries and regions where the share exceeds 10%, 2020-2025**

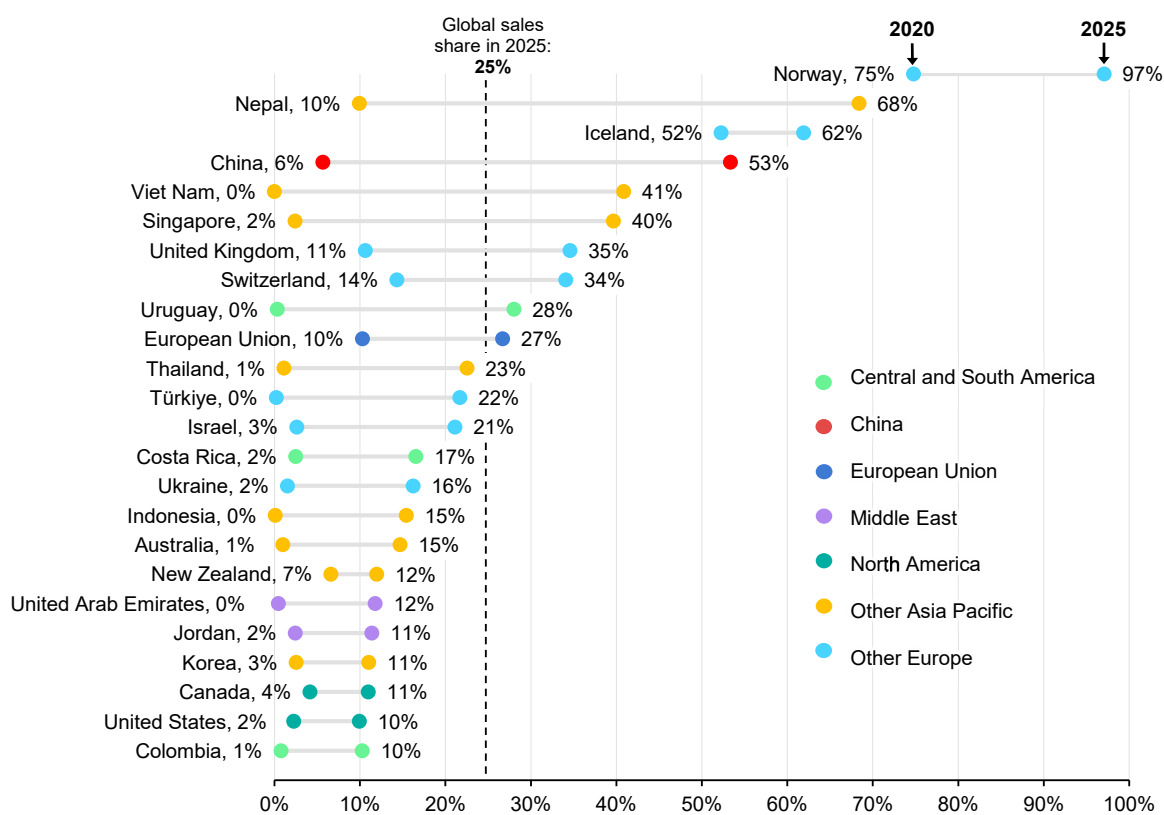

IEA. CC BY 4.0.

Note: Electric cars include battery electric and plug-in hybrid electric vehicles.

Sources: IEA analysis based on [EV Volumes](#), [ACEA](#), [EAFO](#), [ACUA](#), [ODMD](#), [OICA](#), [DLT](#), [VAMA](#), [Gaikindo](#), [LTO](#), [MAA](#), [LTA](#), [Marklines](#), [Sinoimex](#), [AleTech](#), [EU Statistical Pocketbook](#), [ORNL](#), [BTS](#), [CBS](#), [Andemos](#), [NZTA](#), [FCAI](#), and country submissions.

## Across the three major electric car markets, sales growth was strongest in Europe

### Close to 55% of new cars sold in China were electric in 2025

More than 13 million electric cars were sold in China in 2025, maintaining its position as the world’s largest electric car market, accounting for six out of ten electric cars sold globally. Monthly electric car sales exceeded a 50% sales share in 11 out of 12 months of 2025 – up from only 5 months in 2024. This lifted the electric car sales share to almost 55%. As a result, an estimated 44 million electric cars were on Chinese roads at the end of 2025, representing around 13% of the total car stock, up from 1 in 10 in 2024.

Growth in electric car sales in China has been extremely rapid over the past five years: from 2020-24, the annual growth rate in electric cars exceeded 75% and

Growth in electric car sales in China has been extremely rapid over the past five years: from 2020-24, the annual growth rate in electric cars exceeded 75% and the sales share increased by around 10 percentage points on average each year. By contrast, in 2025, electric car sales grew less than 20% and the sales share rose by only about 6 percentage points. However, China remains by far the largest electric car market and has one of the highest sales shares of any country.

Many of the electric car sales in 2025 benefited from the [trade-in scheme](#) that was introduced in April 2024 and [renewed](#) at the beginning of 2025, offering CNY 20 000 (Chinese Yuan renminbi) (USD 2 750)<sup>4</sup> to consumers that replaced an older vehicle with a new electric car, and CNY 15 000 (USD 2 050) for replacement with a new conventional vehicle. In July 2025, the trade-in scheme was temporarily [halted](#) in several cities, causing electric car sales to dip by 10% compared to June. Despite this temporary pause, the scheme still attracted [11.5 million](#) applications over the year, and by November 2025, [nearly 60%](#) of applications were for new energy vehicles.

The trade-in scheme was paused due to limited funding at the provincial level and increasing reports of “[zero-mileage cars](#)”, which are vehicles purchased new and immediately resold on the domestic or global used car market. This allows buyers to take advantage of subsidies and helps manufacturers meet production targets, but they also disrupt pricing for local dealerships.<sup>5</sup> There are no official statistics on the number of zero-mileage cars, but [estimates](#) suggest that roughly 2% of new conventional car sales in 2025 were for zero-mileage used cars, while for electric car sales this percentage may be slightly higher, at roughly 4%.

---

<sup>4</sup> Unless stated otherwise, USD figures are real 2025 dollars in market exchange rate terms throughout this report.

<sup>5</sup> “Zero-mileage cars” are effectively new cars and are counted as such in Chinese sales statistics. However, when these cars are exported and resold abroad, they may be misinterpreted in the destination markets, despite already having been registered once in China. The data shown in this report cannot account for this potential misinterpretation. See box 7.1 on the export of used zero-mileage cars.

**Figure 1.3 Electric car registrations and sales share in selected countries and regions, 2019-2025**

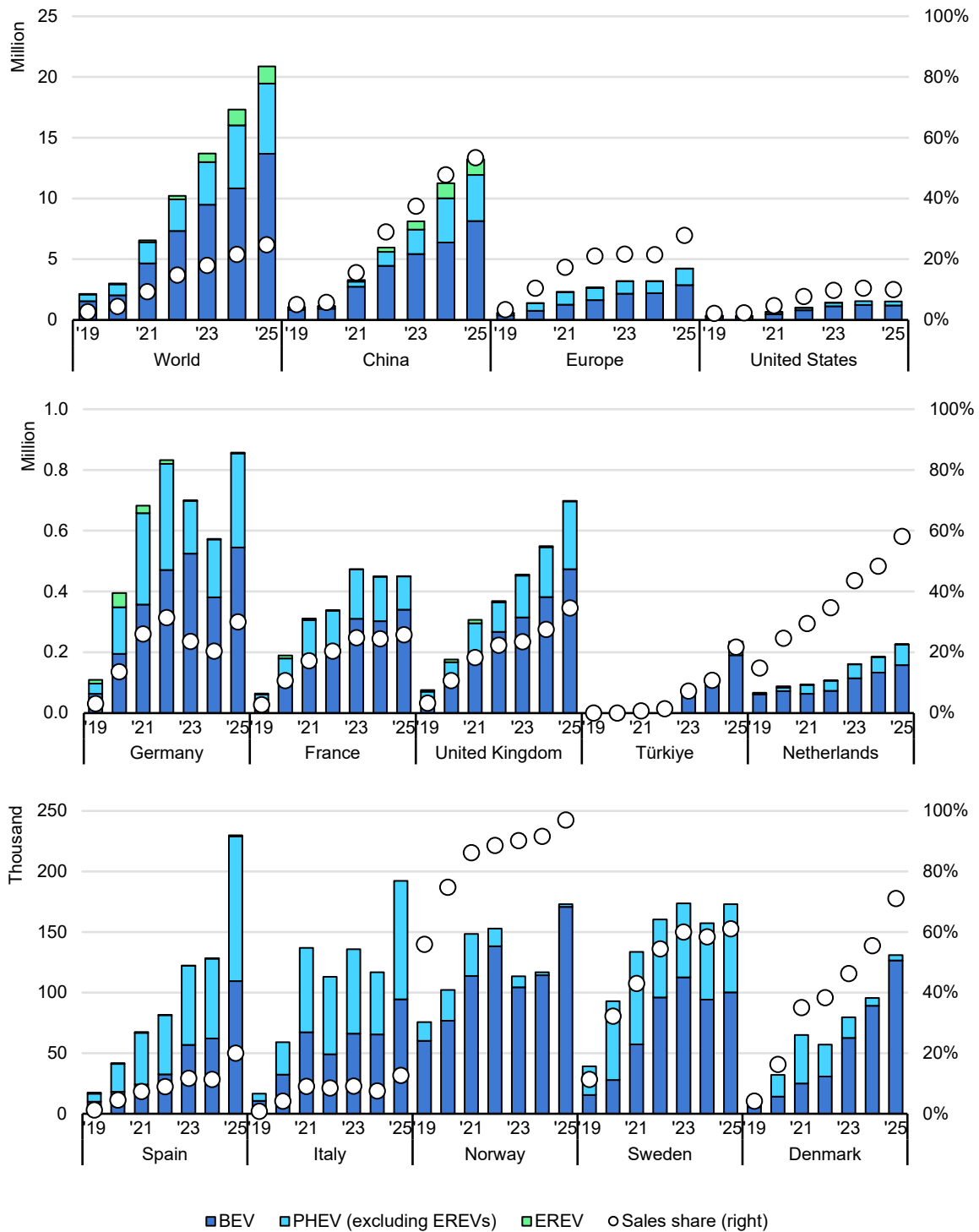

IEA. CC BY 4.0.

Note: BEV = battery electric vehicle; PHEV = plug-in hybrid vehicle; EREV = extended-range electric vehicle.

Sources: IEA analysis based on country submissions and data from [EV Volumes](#), [ACEA](#), [EAFU](#), [ODMD](#).

## Electric car sales saw strong growth in Europe in 2025, thanks to policy support

Electric car sales increased by more than 30% in Europe in 2025, reversing the relative stagnation seen since 2022. Across the region, electric car sales numbered 1 million more in 2025 than in the previous year, reaching a total of 4.2 million, or 28% of all new cars sold. In the European Union, electric car sales totalled almost 3 million and the EV sales share reached just under 27%. Additionally, 24 of the 27 EU member states recorded an increase in electric car sales shares, compared with just 13 the previous year. In more than half of these countries, the sales share rose by more than 5 percentage points.

The increase in EU electric car sales was the result of policy design, notably the step change in the EU CO<sub>2</sub> standards that came into effect in 2025, targeting an emissions reduction of 15% compared to 2021 levels.<sup>6</sup> Towards the end of 2025, the European Commission proposed the [Automotive Package](#), aimed at further increasing regulatory flexibility for 2030 and 2035 while supporting EU industrial competitiveness by promoting vehicles that are made in the European Union as well as electrifying company fleets (see [Chapter 9](#)).

In **Germany**, the largest electric car market in Europe, electric car sales increased by 50% in 2025, to reach a record high of 850 000. This rebound was supported not only by preferential [tax](#) treatment for electric company cars, but also by the wider availability of more affordable models, which contributed to a fall in the average battery electric vehicle (BEV) price of around 6% in 2025. Around 30% of cars sold in Germany in 2025 were electric, just slightly below the 31% sales share achieved in 2022. In **France**, battery electric car sales increased by almost 15% in 2025 while PHEV sales decreased by 25%. As a result, the electric sales share remained similar to 2024 levels, representing around 25% of total car sales. Impressive sales growth in [Italy](#) (+65%), [Poland](#) (+125%) and [Spain](#) (+80%) was supported by the reintroduction or continuation of EV purchase subsidies in 2025.

In the **United Kingdom**, electric car sales increased by more than 25%, accounting for over 1 in 3 new cars sold in 2025 – a significant increase from 1 in 4 new cars in 2024. Nearly half a million electric car sales were battery electric, representing 23% of all new cars sold. This fell short of the target set under the [Vehicle Emissions Trading Schemes](#), which aimed for zero-emission cars (battery electric and fuel cell) to reach 28% of new registrations in 2025. However,

---

<sup>6</sup> Regulation (EU) [2019/631](#), as amended in 2023, established a tightening of CO<sub>2</sub> standards for new passenger cars in 2025, requiring a 15% reduction in fleet-average emissions relative to 2021 levels, following several years without increased stringency (2021-24). While the 2025 target level remained unchanged, in March 2025 the European Commission introduced a [flexibility](#) mechanism allowing manufacturers to average compliance over the 2025-27 period.

manufacturers were still able to [comply](#) with the targets by using the scheme's flexibilities introduced in 2025, such as borrowing credits from future years and earning extra credits. To further support sales, in July 2025 the government introduced a new [subsidy](#) for eligible battery electric cars priced below GBP 37 000 (USD 47 400). More than one-quarter of battery electric car sales were eligible for this subsidy in 2025.

**Norway** remains the world's leading electric car market in terms of sales shares, with about 97% of new car sales being electric in 2025. Nearly all of the 2025 electric car sales were battery electric and less than 2% plug-in hybrid, coming close to the [country's target](#) of selling only zero-emission cars in 2025. Starting in 2026, the purchase tax exemption for battery electric cars will be [tightened](#) to only apply to those priced at NOK 300 000 (Norwegian kroner) (USD 28 000) or less, down from NOK 500 000 (USD 47 000), and will be phased out completely in 2028.

One of the fastest-growing electric car markets in Europe in 2025 was **Türkiye**, where sales more than doubled compared to 2024 to reach nearly 240 000. Electric cars represented over 20% of new car sales in 2025, up from just over 1% in 2022. As a result, Türkiye became the fourth-largest electric car market in Europe last year, following Germany, the United Kingdom and France. Sales have surged since 2023, partly driven by the reduced registration tax ([ÖTV](#)) for BEVs of just 10%, compared to 45-80% for conventional cars. By July 2025, the ÖTV for battery electric cars was raised to [25%](#) for models meeting certain price criteria. Following this change, electric car sales dipped for a few months but rebounded in December to a similar level to in June (over 30 000). The upswing in sales was also supported by growing domestic electric car production: sales from Türkiye's own pure-play EV manufacturer, Togg, rose 30% in 2025. However, Togg's market share decreased from 30% to just over 15% as other brands entered the market. Furthermore, with the introduction of new models, the share of BEVs in electric car sales decreased from 90% to 80%, still significantly higher than the overall share of BEVs in European sales.

Across Europe, the share of BEVs in electric car sales has increased steadily over the past few years, supported by emission standards that favour zero-emission vehicles, in particular the EU CO<sub>2</sub> standards. The BEV share in electric car sales rose from 55% in 2020 to nearly 70% in 2025. As a result, Europe and China reached similar shares of BEVs in EVs in 2025, with Europe ending the year slightly higher.

Overall, electric cars now represent about 5% of the European car fleet. Norway leads, with more than one-third of the car stock being electric. Within the European Union, only Denmark has a stock share above 20%, reflecting the lag between rapid sales uptake and stock turnover.

## In the United States, electric car sales fell sharply in the last quarter of 2025

Electric car sales in the **United States** in 2025 were slightly lower than in 2024, at around 1.5 million. This stagnation was the result of several policy shifts. At the beginning of 2025, [Executive Order 14154](#) directed the government to end support for EVs, including measures related to financial incentives and fuel economy standards. In July 2025, the [One Big Beautiful Bill Act](#) (OBBBA) eliminated the financial penalties for non-compliance with existing fuel economy standards, providing carmakers less incentive to sell EVs in the United States. The OBBBA also terminated tax credits for new and used electric car purchases after September 2025. As a result, new electric car sales in the fourth quarter of 2025 were 45% lower than in the fourth quarter of 2024, offsetting the almost 15% increase in Q1-Q3 sales in 2025 compared to the same period the previous year. Some of the sales prior to the fourth quarter were made in anticipation of the end of the tax credits. Although electric cars made up only 6-7% of car sales in Q4 2025, they represented around 10% of sales across the full year, only slightly less than in 2024.

## Sales outside major markets reached nearly 2 million in 2025

### Emerging markets represent an increasing share of global electric car sales

Outside the three major electric car markets – China, Europe and the United States – electric car sales increased steadily to reach 2 million in 2025, compared to 1.3 million sold the previous year. This nearly 50% growth can mainly be attributed to increasing sales in emerging markets and developing economies (EMDEs) other than China.

Electric car sales in these economies increased by around 80% in 2025, to reach almost 1.2 million, a record high. Rapid sales growth in these markets has mainly been driven by the increasing availability of lower-cost electric car models, many of which are imported from China (accounting for 60% of sales in EMDEs other than China). Several markets doubled in size compared to 2024, with Southeast Asia demonstrating the largest absolute increase in sales. The share of BEVs in electric car sales (80%) is higher than in major markets (65%), but this is not a uniform trend across emerging markets. In Southeast Asia, more than 90% of electric car sales are for BEVs, but the opposite trend can be seen in other countries, such as Brazil (45%) and Uzbekistan (33%), where BEVs represent a minority share of electric car sales.

**Figure 1.4 Electric car registrations and sales share in countries and regions outside the three major electric car markets, 2020-2025**

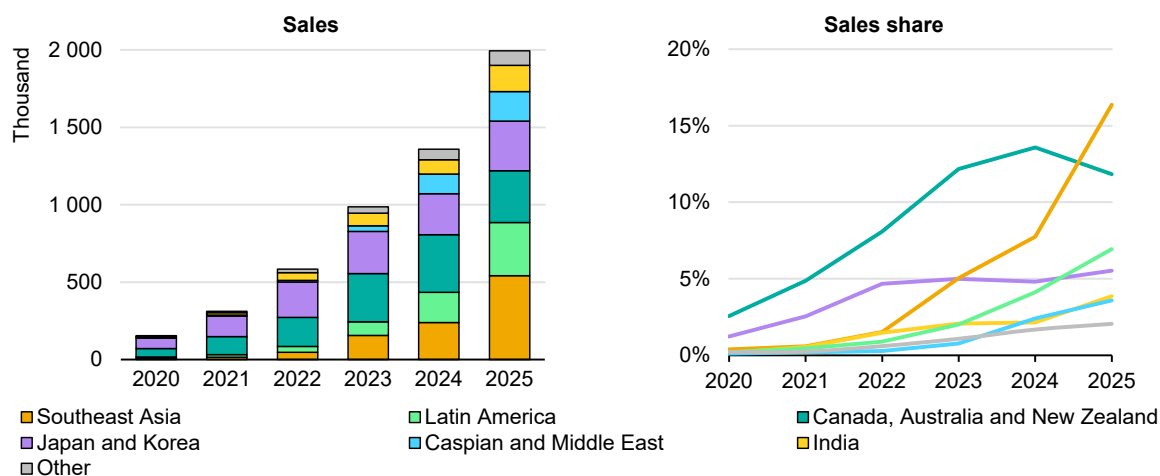

IEA. CC BY 4.0.

Sources: IEA analysis based on country surveys and [EV Volumes](#), [Vahan](#), [DLT](#), [VAMA](#), [Gaikindo](#), [LTO](#), [MAA](#), [LTA](#), [Marklines](#).

## Electric car sales took off in Korea in 2025, in contrast to several other advanced economies

Electric car sales in **Korea** grew by around 65% year-on-year to reach more than 200 000 in 2025, after years of hovering around 130 000. As a result, the sales share of electric cars reached double digits (11%) for the first time. The government helped support sales earlier in 2025 by bringing forward the release of [purchase guidelines](#) compared with previous years. In addition, at the start of 2026, the government raised its [zero-emission vehicle deployment target](#), aiming for electric and fuel cell electric vehicles to account for 50% of new car sales by 2030, providing a clearer signal for manufacturers to expand production capacity.

In **Japan**, despite [subsidy](#) support, electric car sales momentum remained weak for the second year in a row in 2025, with volumes similar to 2024 levels (just above 100 000). Electric cars accounted for less than 3% of sales, while conventional hybrid electric vehicles (HEVs) accounted for around one-third of all car sales in 2025. This reflects the long-standing focus of Japanese automakers on hybrid technologies to reach [fuel economy](#) requirements. In addition, the high share of the population living in apartments with limited access to private parking, in combination with charging infrastructure [constraints](#), are slowing sales.

In **New Zealand**, electric car sales stabilised in 2025 after a large drop in sales of 70% in 2024 after the removal of the [Clean Car Discount](#). In **Australia**, electric car sales rose steadily in 2025, reaching around 15% of new car sales as a increasing share of PHEV sales supported growth.

In **Canada**, electric car sales in 2025 were more than 30% lower than in 2024, due in part to the ending of the [iZEV](#) rebate programme at the beginning of the year. This programme offered up to CAD 5 000 (Canadian dollars) (USD 3 500) for eligible BEVs, and CAD 2 500 (USD 1 750) for PHEVs. The sales share of electric cars decreased from nearly 17% in 2024 to 11% in 2025.

**Figure 1.5 Electric car registrations and sales shares for selected countries, 2021-2025**

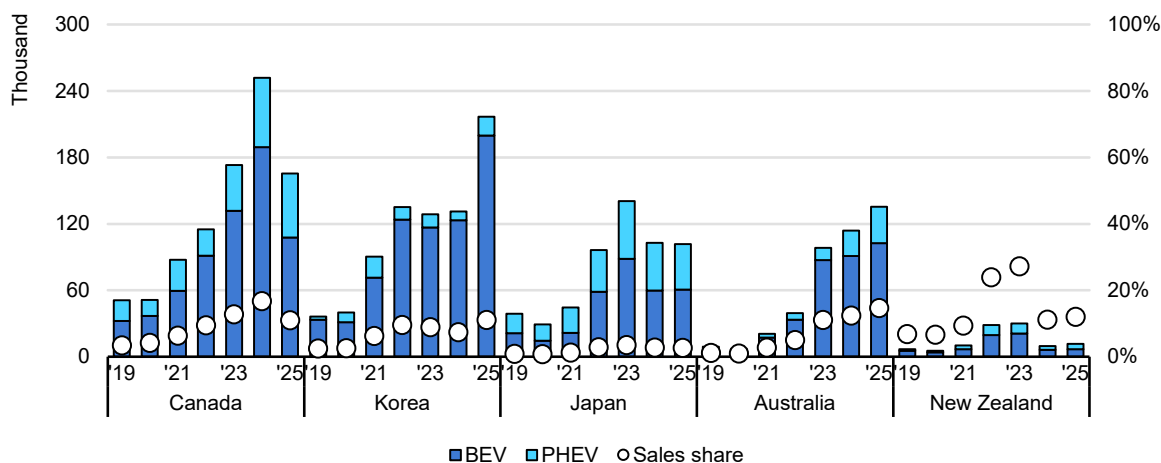

IEA. CC BY 4.0.

Note: BEV = battery electric vehicle; PHEV = plug-in hybrid vehicle.

Sources: IEA analysis based on country submissions and data from [EV Volumes](#) and [Marklines](#).

### In Southeast Asia, electric car sales more than doubled in 2025

In 2025, **Southeast Asia** saw one of the world’s largest increases in electric car deployment, with sales more than doubling year-on-year to more than half a million. Across the region, electric cars represented close to one in five cars sold. However, trends were uneven: Viet Nam, Indonesia and Thailand led the EV sales growth in the region, supported by strong policy incentives, the expansion of domestic manufacturing and favourable trade conditions for imports, particularly from China. On the other hand, electric sales shares remained somewhat lower in Malaysia and the Philippines, despite growing rapidly.

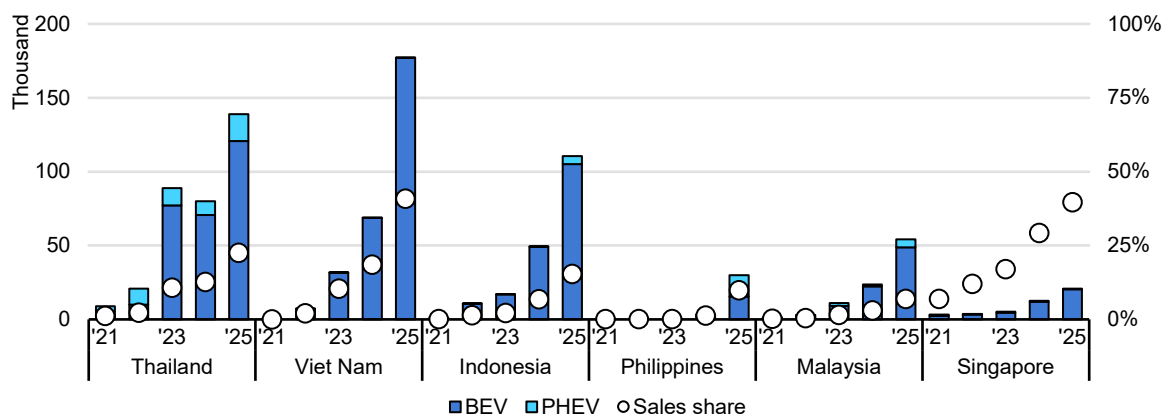
**Figure 1.6 Electric car registrations and sales shares in Southeast Asia, 2021-2025**

IEA. CC BY 4.0.

Note: BEV = battery electric vehicle; PHEV = plug-in hybrid vehicle.

Sources: IEA analysis based on country submissions and data from [EV Volumes](#), [DLT](#), [VAMA](#), [Gaikindo](#), [LTO](#), [MAA](#), [LTA](#) and [Marklines](#).

Sales in **Viet Nam** more than doubled in 2025, promoting the country to Southeast Asia's largest electric car market, with nearly 40% of new car sales being electric, above levels seen in most European countries. Policy support for electric car purchases has primarily been provided through [registration fee exemptions](#) for BEVs since 2022. The domestic EV maker VinFast has captured nearly the entire market, and its small affordable models have been key enablers of mass-market adoption. In 2025, the price-competitiveness of best-selling EV models [VF3](#) and [VF5](#) helped them outsell conventional rivals in similar size segments.

In 2025, electric car sales in **Thailand** increased by 70% from 2024 levels, reaching roughly 140 000, nearly one-quarter of total new car sales. As a result, the country represented the second-largest electric car market in the region. The [EV3.5 scheme](#) that came into force in January 2024 continued to boost adoption through purchase subsidies, excise tax breaks and import duty reliefs. In addition, the [EV3.0 scheme](#) drove an increase in Thai-made electric car sales, by requiring manufacturers to register their domestic electric car production before January 2026 in exchange for the import duty exemptions. Thai-made electric cars represented 20% of the market in 2025, up from about 5% the year before. Despite policy settings shifting to [support domestic production](#), Chinese-made electric cars still represented three-quarters of the Thai market in 2025 (see [Chapter 7](#)).

In **Indonesia**, electric car sales more than doubled in 2025, reaching 15% of new car sales. Key policy support measures were [VAT](#) and [import duty](#) exemptions for battery electric cars. In anticipation of the tariff exemption for battery electric car imports coming to an end in December 2025, manufacturers ramped up imports

towards the end of the year, resulting in about half of 2025 sales taking place in the last quarter. About 75% of 2025 sales were imports from China, while the rest were cars produced domestically by Chinese carmakers (mostly by Wuling) – supported by a wide range of manufacturing [incentives](#) – and imports from neighbouring countries such as Viet Nam and Thailand. As industrial and trade policies shift the focus towards local production, the importance of imports in Indonesia’s electric car market is set to wane in 2026.

While electric car sales also doubled in **Malaysia** in 2025, uptake was lower than in other neighbouring markets, with the share of electric cars in new car sales standing at about 7%. Southeast Asia’s largest car market has been supporting electric car adoption primarily through [excise tax and import duty exemptions](#), resulting in Chinese imports accounting for as much as 80% of the market in 2025. These exemptions ended at the end of 2025 but remain active for completely knockdown kit (CKD) imports until the end of 2027, to enable domestic assembly with cost-competitive imported parts.<sup>7</sup> Several domestic car makers, such as [Proton](#) and [Perodua](#), have also started to add electric models to their line-ups. In 2025, Proton’s best-selling electric cars were the e.MAS 5 and e.MAS 7, which were among the most competitively priced electric models on the market, priced at only around 10% more than comparable conventional cars (see [Chapter 2](#)).

Electric car sales leapt up in the **Philippines** in 2025, reaching almost 10% of new car sales, up from a negligible level the year before. Similarly to other Southeast Asian countries, policy support in the Philippines takes the form of [excise tax relief](#) (introduced at the start of 2025) and [import duty exemptions](#) (introduced in 2024) for electric cars. As a reflection of this, Chinese imports, particularly from BYD, made up most of the country’s electric car sales in 2025. The importance of Chinese imports is set to continue in the near term, with the [tariff exemption running until 2028](#).

## Electric car sales in India remain modest but are starting to pick up

Despite being the second-largest car market in the Asia Pacific region, India’s electric car sales remained below levels seen in Viet Nam and Thailand. However, sales started to pick up in 2025, increasing 75% year-on-year to reach 165 000, representing nearly 4% of total car sales. Roughly 60% of electric car sales were produced in India by domestic automakers Tata and Mahindra. Mahindra

---

<sup>7</sup> Completely built-up (CBU) vehicles are fully assembled vehicles imported into a country ready for sale and use. Completely knockdown (CKD) vehicles are shipped as a full set of parts that require complete assembly in the destination market. Semi-knockdown (SKD) vehicles are partially assembled units requiring limited final assembly before sale. CKD and SKD trade usually allows manufacturers to reduce import tariffs and supports the gradual development of local supply chains.

introduced two new electric models in 2025, and saw electric car sales increase fivefold compared to 2024. Besides local automakers building up sales, more brands started to sell electric cars in India, with the number of electric models available increasing from 33 to 45 between 2024 and 2025.

Following the announcement by the Indian government in 2024 of the Scheme to Promote Manufacturing of Electric Passenger Cars in India ([SPMEPCI](#)), the final requirements were announced in June 2025. The SPMEPCI will allow selected automakers to import higher-priced CBUs at a minimum import value of USD 35 000 with a reduced import rate of 15%, compared with duties of up to 110% for non-eligible imports, for a period of five years. While several automakers expressed interest, decisions to participate were delayed in 2025, with companies [citing](#) uncertainty related to the ongoing European Union-India free trade agreement negotiations and Chinese restrictions on rare-earth magnet exports, which raised concerns about meeting the scheme’s localisation requirements.

### Brazil and Mexico were behind the 75% electric car sales growth observed in Latin America in 2025

Electric car sales growth accelerated across major markets in Latin America in 2025, to reach more than 350 000 cars – an increase of 75% compared to 2024. More than 75% of the region’s sales growth came from Brazil and Mexico, where PHEV sales, in particular, expanded rapidly. As a result, PHEVs represented close to 50% of electric car sales in Latin America in 2025, up from 40% the year before. Several smaller Latin American markets, such as Uruguay, Costa Rica and Colombia, also saw sales growth, mostly of battery electric cars, thanks to tax and import incentives.

**Figure 1.7 Electric car registrations and sales shares in Latin America, 2021-2025**

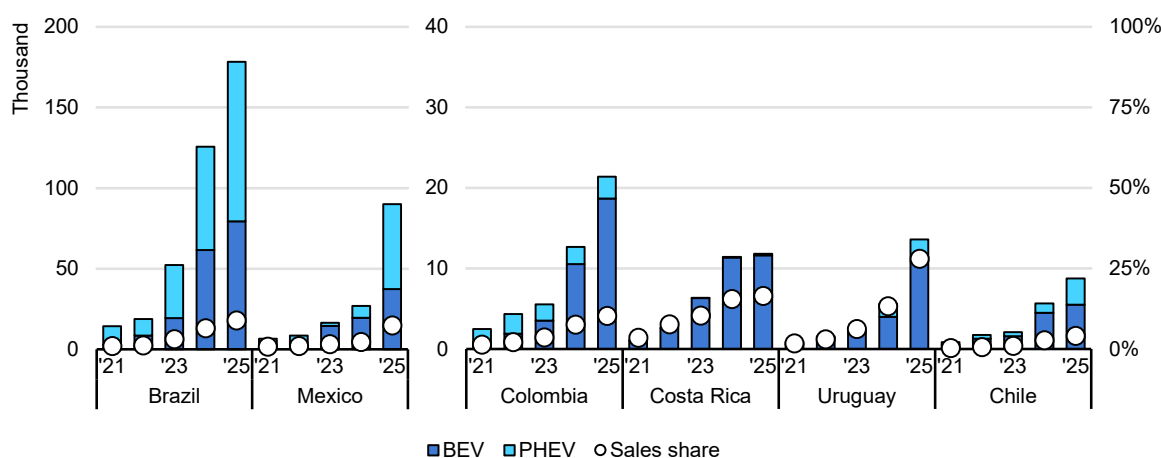

IEA. CC BY 4.0.

Note: BEV = battery electric vehicle; PHEV = plug-in hybrid vehicle.

Sources: IEA analysis based on country submissions and data from [EV Volumes](#), [ACAU](#), [AleTech](#) and [Marklines](#).

Electric car sales in **Brazil** surged to 180 000, or 9% of all new car sales, up from 6.5% in 2024. Brazil is one of the few countries where more PHEVs are sold than BEVs; the share of PHEVs in EV sales has hovered between 60% and 50% over the past few years. Growth has been driven by [reduced](#) import tariffs for electric cars, which are being gradually reinstated. In 2025, just under 85% of all electric cars sold in Brazil were made in China, a slightly smaller share than in 2024. This can be attributed in part to the opening of a [Great Wall Motors](#) plant in Brazil, which produced just under 5% of electric cars sold in the country in 2025. In addition, [BYD](#) started operations of its new factory in Brazil in 2025. One of the models it will produce is the Song Pro, which is flex-fuel compatible, specifically tailored to the Brazilian market.

Electric car sales in **Mexico** tripled in 2025, with sales of plug-in hybrid electric cars increasing sevenfold. As a result, the share of electric car sales in total car sales topped 7% in 2025, up from around 2% in 2024. Imports from China increased significantly, with 85% of electric car sales in 2025 being imports from China, up from just over 60% in 2024 (see [Chapter 7](#)), despite the reinstatement of [import tariffs](#) for electric cars in October 2024. BYD has announced plans for local production, but as of 2025 no large-scale manufacturing had begun. Geely and BYD are currently among the [bidders](#) to take over a factory in the country from Nissan.

Aside from the major markets, many countries in Latin American and the Caribbean now have either import or purchase tax exemptions for EVs in place.<sup>8</sup> **Uruguay** has become one of the region's front-runners in switching to electric cars: Sales of electric cars more than doubled between 2024 and 2025, reaching 13 500 cars, or nearly 30% of total new car sales in the country. Uruguay's market is strongly skewed toward BEVs rather than PHEVs, supported by government policies such as [tax exemptions](#) and [subsidies](#). Furthermore, gasoline prices are much higher compared to other Latin American countries, further supporting the adoption of BEVs: in 2025 the average gasoline price was USD 2 per litre, 75% higher than in Brazil or Argentina.

**Costa Rica** reached an electric car sales share of 17% in 2025, up from 15% in 2024. Recent growth in Costa Rica has been partly due to [tax exemptions](#) for electric models, which are gradually being [phased out](#) between 2025 and 2035. **Colombia** also experienced a rapid increase in EV sales, supported by greater availability of cheaper Chinese models, [tax exemptions](#), and sharply rising gasoline prices following the phase-out of fuel subsidies in 2023.

---

<sup>8</sup> This includes Argentina, Costa Rica, Brazil, Bolivia, Chile, Ecuador, Saint Lucia, Trinidad and Tobago and Guatemala, Uruguay, El Salvador and Jamaica.

One of the only countries in [Latin America](#) with mandated fuel economy standards is **Chile**, through its [Energy Efficiency Law](#) which started to be implemented in 2024. As a result, the average fuel economy of new car sales has since improved by over [17%](#) annually, largely due to electric car sales. Electric car sales quadrupled in Chile between 2023 and 2025, to represent roughly 4% of total car sales. In **Argentina**, electric car sales remained very limited, with fewer than 2 000 cars sold in 2025. However, the BEV segment expanded significantly, with sales more than doubling, thanks to the market launch of two new BYD models. In addition, in 2025 the [city of Buenos Aires](#) introduced incentives such as exemptions from licence plate fees and road tolls for electric and hybrid vehicles, applicable until mid-2026, helping to gradually improve the attractiveness of electric mobility.

### Eurasian and Middle East regions show continued growth

Electric car sales only began to pick up in the Eurasian region from 2023 onwards, rising from just a few hundred sales in 2022 to more than 60 000 in 2025. **Uzbekistan** accounted for nearly half of the region’s electric car sales in 2025, with electric cars reaching 8% of total car sales. Uzbekistan is also the main car assembler in the region and hosts an EV [production plant](#) owned by a joint venture between BYD and UzAuto Motors. Electric car sales also grew rapidly in **Tajikistan** and **Kyrgyzstan**. In 2025, these two countries represented more than 30% of electric car sales in the region. BYD accounted for around 80% of all electric cars sold in the region, including those supplied through the joint venture with UzAuto Motors. Nevertheless, around 95% of electric cars sold in the Caspian region in 2025 were produced in [China](#).

**Figure 1.8 Electric car registrations in selected Middle Eastern and Eurasian countries, 2021-2025**

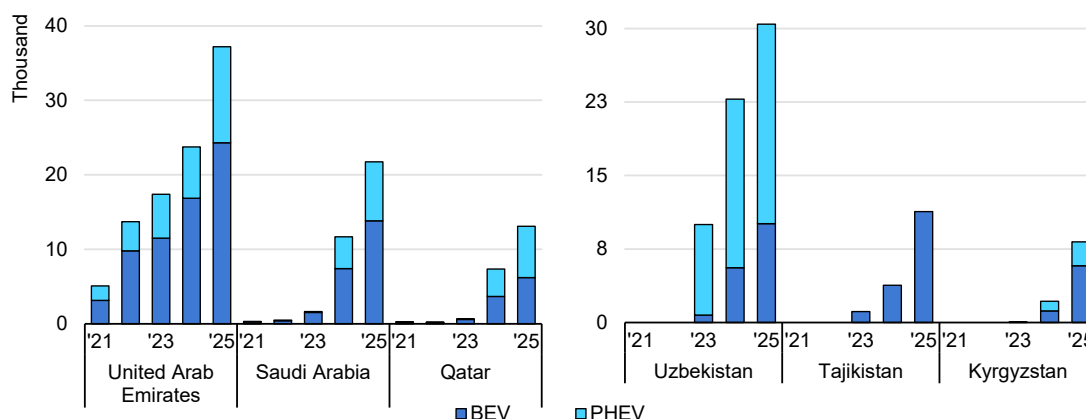

IEA. CC BY 4.0.

Note: BEV = battery electric vehicle; PHEV = plug-in hybrid electric vehicle.

Sources: IEA analysis based on country submissions and [EV Volumes](#), [ReviewUZ](#), and [Marklines](#).

Electric car sales in the Middle East reached around 75 000 in 2025, expanding by more than 40% year-on-year. The **United Arab Emirates** remained the region's largest electric car market, accounting for almost 50% of sales, though its share of the regional market has declined from over 60% in 2023 as neighbouring markets have gained momentum. Sales have grown particularly quickly in **Qatar** and **Saudi Arabia**, which together now represent nearly 45% of regional demand. Market preferences have also shifted markedly in recent years. When electric car sales first began to scale in 2020, US-manufactured Tesla models accounted for about half of all sales. Today, Tesla's share has fallen to around 15%, while BYD – which entered the regional market in 2022 – has rapidly expanded to a 60% market share.

### Adoption of new electric cars in Africa has been limited to a few countries to date

In the past two years, the electric car market in Africa increased from around 4 000 car sales in 2023 to about 25 000 in 2025, driven primarily by sales growing in Egypt (7 900), Morocco (5 500) and South Africa (3 800), which together accounted for nearly 70% of regional sales in 2025. However, Ethiopia, Mauritius, Rwanda and Nigeria have also seen progress in electric car uptake. In South Africa, electric car sales remained at less than 1% of new car sales in 2025, but PHEV sales saw a strong increase, resulting in PHEV sales accounting for more than 70% of total electric car sales.

The African car market is in large part reliant on [used exports](#) from car-producing countries such as Germany, Japan and the United States. It is estimated that around 60% of all annual additions to the car stock in Africa are imported used cars. Therefore, tracking new electric car registrations or sales may not accurately reflect adoption of EVs in Africa. [Data](#) on the electrification of used exported cars is limited and further complicated by exports of zero-mileage vehicles (see box 7.1).

The number of new registrations or sales can also be difficult to track, as new sales and used imports are often not distinguished in country statistics. Estimates of sales for Ethiopia, in particular, vary widely. Cumulative retail sales of new electric cars between 2021 and 2025 amount to slightly over 2 000. However, the vehicle licensing authority reports a cumulative [15 000](#) electric cars sold between 2022 and 2024, and that approximately half of all new cars sold in 2024 were electric.

As in many other EMDEs, the share of electric car sales coming from Chinese automakers is increasing. In 2023, roughly 40% of electric car sales in Africa came from European automakers, while BYD held only a 4% market share. By 2025, BYD accounted for 35% of all electric cars sold in the region. There are, however,

developments underway from domestic manufacturers, and Moroccan automaker [Neo Motors](#) started to sell its first electric model at the beginning of 2026.

**Figure 1.9 Electric car registrations in selected African countries, 2021-2025**

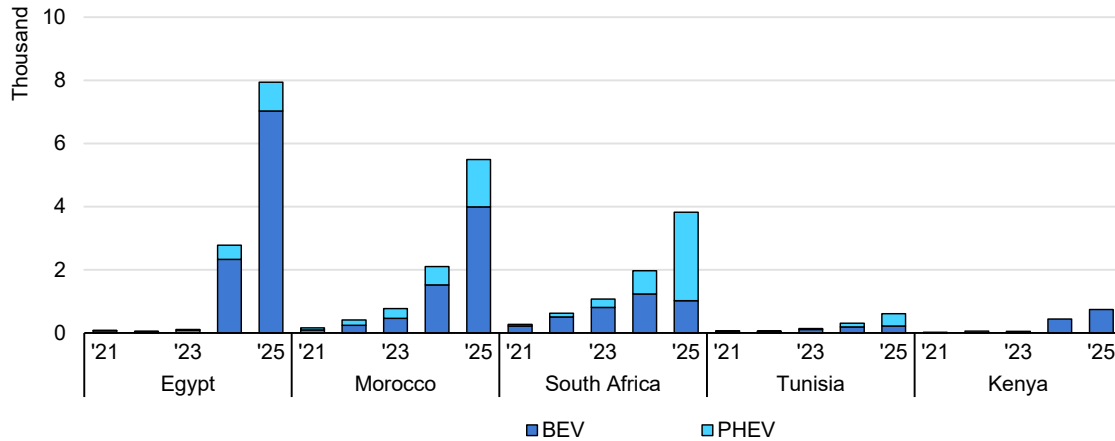

IEA. CC BY 4.0.

Note: BEV = battery electric vehicle; PHEV = plug-in hybrid electric vehicle.

Sources: IEA analysis based on country submissions and [EV Volumes](#), [North Africa Post](#).

## Model availability and range

### The number of electric car models keeps growing, in contrast to conventional car models

Some 2 500 car models were available worldwide in 2025. Nearly 1 000 of these were electric cars, about 40% of the total, up from about 35% in 2024. Counting both battery electric and plug-in hybrid electric models, the number of electric car models has more than doubled in the past five years. In 2025, the number of electric car models available worldwide increased by slightly more than 25%, a larger increase than the just over 15% seen in 2024. Hybrid model availability also continued to expand, rising by over 10% year-on-year to more than 200 models in 2025. By contrast, the number of internal combustion engine (ICE) car models remained constant in 2025 – the only powertrain category to do so.

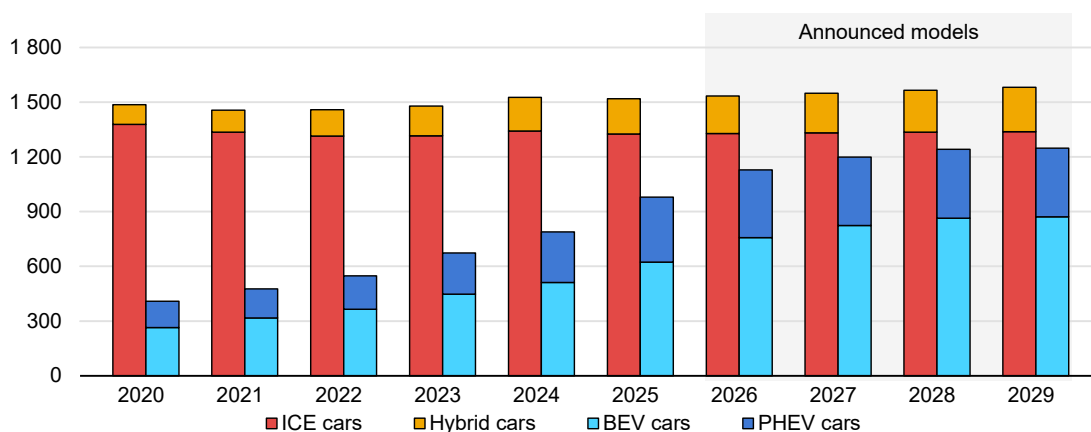
**Figure 1.10 Number of car models available worldwide by powertrain, 2020-2029**

IEA. CC BY 4.0.

Notes: ICE = internal combustion engine; BEV = battery electric vehicle; PHEV = plug-in hybrid electric vehicle. Future model availability is based on EV launch announcements and the extrapolation of historic ICE and hybrid electric vehicle model availability trends.

Sources: IEA analysis based on data from [EV Volumes](#) and [Marklines](#).

The total number of electric car models could exceed 1 100 in 2026, based on recent original equipment manufacturer (OEM) announcements, growing at around 15% compared to the previous year. BEVs continue to account for around 65% of all electric car models, a share that has remained broadly stable since 2015. Looking forward, the share of PHEVs in total electric car models is expected to decline from around 35% in 2026 to around 30% by the end of the decade.

Around 150 new electric models have been announced for release in 2026, followed by approximately 70 in 2027 and 40 in 2028. Looking further ahead, seven models have already been announced for 2029. In aggregate, announcements suggest that electric model availability in 2029 will be over 25% higher than in 2025. Extrapolating historic trends, hybrid model availability could increase by around 30% to 2029, while ICEV model availability plateaus. As a result, the number of announced electric models around the world would be nearly 25% lower than the number of conventional models in 2029. However, this varies by region, reflecting differences in market structure, policy contexts and overall OEM strategies. While early announcements of new electric models point to continued build-up of EV model pipelines (see section on [Carmaker electrification announcements in Chapter 9](#)) for some OEMs, others are putting more emphasis on alternative options, for example by prioritising hybrids.

Globally, SUV model availability has expanded steadily and now represents the largest segment, accounting for around half of all available electric models in 2025. As a result, large vehicles including SUVs accounted for almost 70% of all models available in 2025, up from around 55% in 2020. In contrast, small cars represented only around 10%.

## Model availability continues to shift towards larger vehicle segments

Figure 1.11 Number of car models available by powertrain, size and region, 2024-2025

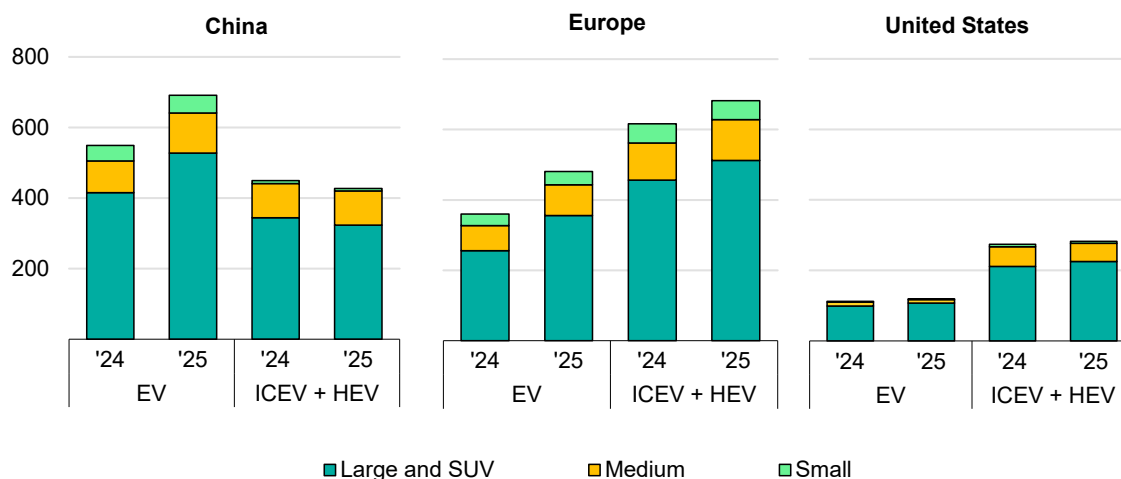

IEA. CC BY 4.0.

Notes: EV = electric vehicle, including battery electric and plug-in hybrid electric vehicles; ICEV = internal combustion engine vehicle; HEV = hybrid electric vehicle; SUV = sports utility vehicle. See [Annex B](#) for definition of car size groups. Sources: IEA analysis based on data from [EV Volumes](#), [Marklines](#).

In **China**, growth in the number of electric car models, especially large models, was the main driver of an expansion in car model availability last year. The total number of available car models increased by around 10% in 2025 to more than 1 100, while the number of electric models increased around 25%. As of the end of 2025, there were nearly 700 electric car models available, 60% more than the number of conventional car models. Among major global automotive markets, such as China, Europe, the United States and Japan, China is the only market with more electric than conventional models, reflecting that competition among Chinese OEMs is increasingly focused on EVs. Despite the number of large and SUV EV models growing over 25% in 2025 in China, their share of total electric car sales only increased by one percentage point, to reach more than 60%, although 2025 sales were 25 percentage points higher than 2020 levels.

Among the three major electric car markets, **Europe** recorded the fastest growth in electric car model availability in 2025. The total number of electric car models increased by nearly 35%, reflecting an uptick in model launches ahead of the introduction of the more stringent 2025 [EU CO<sub>2</sub> target](#). At the same time, Europe continued to have the highest number of conventional car models available, with 580 ICE models and nearly 100 hybrid models in 2025. Large cars and SUVs accounted for almost three-quarters of EV and conventional vehicle models in

2025. However, the availability of small EVs in Europe has improved significantly in recent years and is set to expand further in response to upcoming EU policy developments (see Box 1.1).

The **United States** has the highest share of large models within its EV line-up: over 85% of electric models are large cars or SUVs, compared with roughly three-quarters in Europe and China. This is also reflected in sales, with large cars and SUVs accounting for over 80% of all car sales in the United States. Among all available car models in 2025, ICE models accounted for about 60%, electric for nearly 30%, and hybrid around 10%. Compared to 2024, model availability across ICEs, EVs and HEVs remained broadly unchanged in 2025. This follows recent policy changes and past uncertainty around fuel economy and emissions standards.

**Figure 1.12 Breakdown of electric car sales in selected countries and regions by car size, 2020-2025**

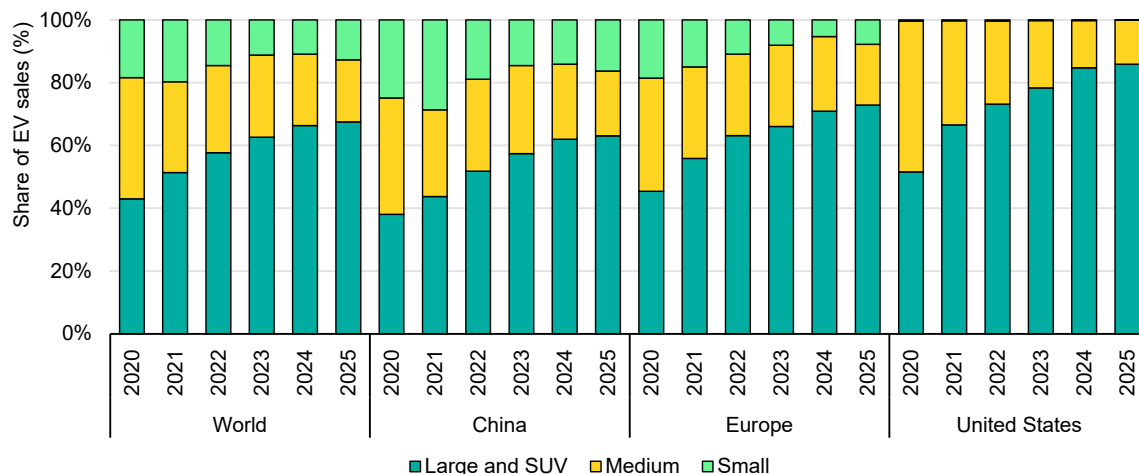

IEA. CC BY 4.0

Notes: EV = electric vehicle, including battery electric and plug-in hybrid electric vehicles; SUV = sports utility vehicle. "Large and SUV" includes large cars, SUVs and passenger pick-up trucks. See [Annex B](#) for definition of car size groups. Source: IEA analysis based on data from [EV Volumes](#).

**Box 1.1 Small, affordable battery electric cars gain traction amid EU policy shifts**

Since 2024, against the backdrop of evolving EU CO<sub>2</sub> emission targets, carmakers have added more affordable battery electric car models to their line-ups to enable wider adoption and comply with the increasing stringency of emission targets. A handful of small, mass-market models have entered the

EU market, including Renault’s 4 and 5, Hyundai’s Inster, BYD’s Seagull and Leapmotor’s T03. As a result, the sales share of small battery electric cars increased in 2025 – reversing five years of declining shares – and capturing nearly one-tenth of the electric car market.

In December 2025, the European Commission presented its [Automotive Package](#), introducing CO<sub>2</sub> compliance credits for small, affordable electric cars that are made in the European Union. These vehicles, known as “M1E”, are defined as battery electric passenger cars (M1) with an overall length of less than 4.2 metres. M1E cars generate 1.3 credits that can be used towards meeting emissions targets, thereby creating a new compliance lever for carmakers, although use of M1E credits prohibits carmakers from pooling credits with pure-play EV makers. In the first quarter of 2026, over one-fifth of the BEVs sold in the European Union would qualify as M1E, provided that local content requirements are met (see [Chapter 9](#)).

**BEV sales shares and number of models with overall length of less than 4.2 metres in the European Union, 2020-2026**

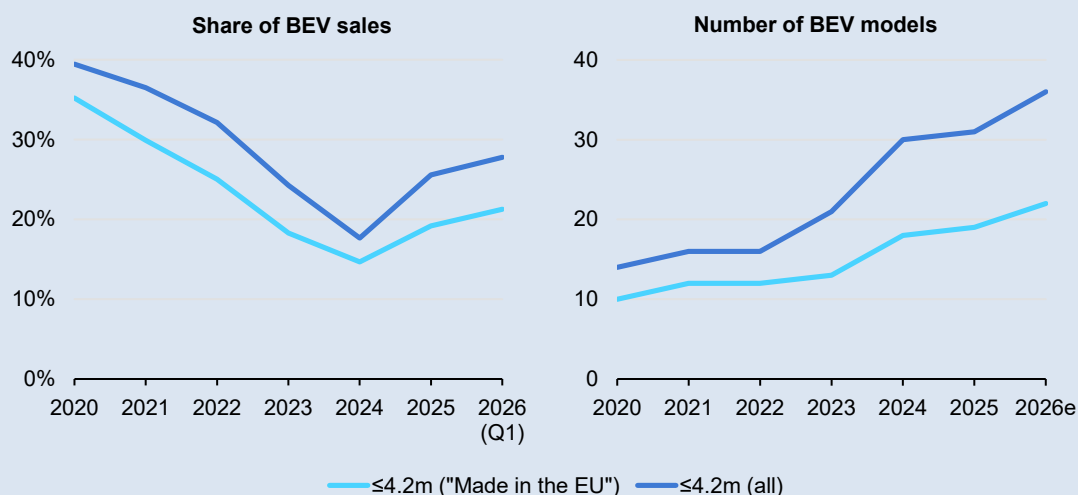

IEA. CC BY 4.0.

Notes: EU = European Union; BEV = battery electric vehicle. 2026e shows expected sub-4.2 metre BEV model count by the end of 2026.

Sources: IEA analysis based on [EV Volumes](#) and OEM model launch announcements.

While the full impact of this initiative on model line-ups will not be seen immediately, the availability of under-4.2 metre BEV models has already made significant strides in recent years. In 2025, about 30 BEV models met this size criterion, almost double the number available three years earlier, although fewer than 20 were assembled in the European Union and would potentially qualify for compliance credits. Looking ahead, this measure is likely to support the market entry of forthcoming small models made in the region such as the Renault Twingo, Volkswagen ID.1 and ID.2, and Kia EV2, potentially increasing the pool of eligible M1E models to more than 20 by the end of 2026.

## Just five models represent around 20% of global battery electric car sales

While model availability shapes consumer choice, greater availability is not necessarily reflected in EV purchase decisions; instead, buyers often tend to pick one of a relatively small number of very popular models. In 2025, 630 battery electric car models were available globally, yet sales remained highly concentrated across a small group of best-selling models. In 2025, just five models accounted for about 20% of global battery electric car sales: the Tesla Model Y made up nearly 8% of total battery electric car sales, followed by the Tesla Model 3 (3.6%), Geely Geome Xingyuan (3.5%), Wuling HongGuang Mini (3.1%), and BYD Seagull (3.0%). As a result, just 1% of available BEV models captured one-fifth of the entire global market. The top-selling 35 models accounted for around half of global battery electric car sales. Nevertheless, as EV adoption grows, automakers tend to offer a greater range of electric car models, which leads to a diversification of consumer choice. As recently as 2020, only two models accounted for about 20% of global battery electric car sales.

**Figure 1.13 Battery electric car models by sales volumes and location of manufacturer headquarters, 2025**

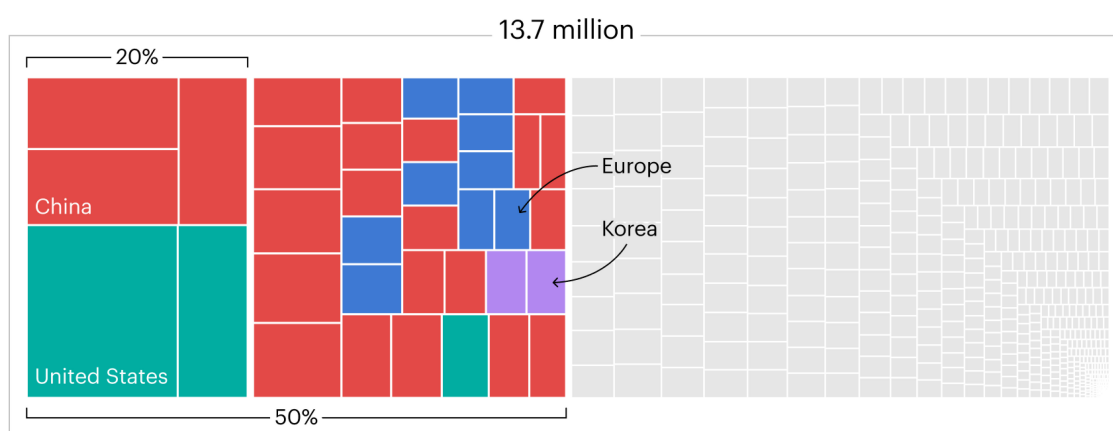

IEA. CC BY 4.0.

Notes: This figure presents battery electric car sales by model in 2025. Each rectangle represents an individual model, with size proportional to sales volume. Colours indicate the headquarters location of the carmaker for the models representing 50% of battery electric car sales; the grey segments are the remaining battery electric models and belong to carmakers from any region.

Sources: IEA analysis based on data from [EV Volumes, Marklines](#).

Sales are also concentrated in terms of where their manufacturers are headquartered. Chinese manufacturers accounted for more than half of the total BEV models available, and of global BEV sales in 2025. Manufacturers headquartered in Europe accounted for nearly one-fifth of models sold, followed by those based in United States, which made up nearly 10% (see Chapter 7 for the latest manufacturing and trade trends).

## The average range of battery electric cars is plateauing

Vehicle range [remains](#) one of the key considerations for potential electric car buyers. The average battery electric car range is currently almost 380 km, and this has plateaued in recent years. The average range of small and medium-sized cars increased by about 7% and 5% in 2025, but global electric car sales have become increasingly concentrated in larger segments, with large cars and SUVs accounting for almost 70% of the global EV market in 2025. Sales-weighted battery electric car range rose by roughly 10% between 2020 and 2025. At the same time, public charging infrastructure has expanded rapidly, including along long-distance corridors, helping to reduce range anxiety.

As electric car markets partially shifted from high-income early adopters to include a wider range of consumers, including those with lower incomes, the greater availability of affordable, shorter-range models in electric car sales contributed to the plateauing of global average driving ranges. This may indicate a consumer or carmaker preference to balance range with overall vehicle costs.

**Figure 1.14 Sales-weighted average on-road electric range of electric cars by segment, 2015-2025**

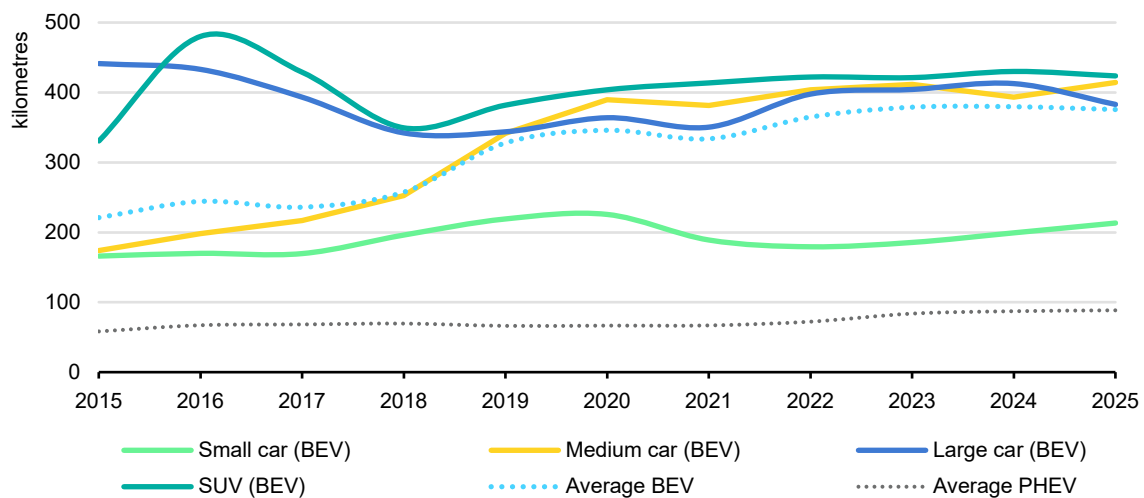

IEA. CC BY 4.0.

Notes: BEV = battery electric vehicle; PHEV = plug-in hybrid electric vehicle; SUV = sports utility vehicle. Range is calculated using the global sales-weighted average vehicle efficiency of BEVs and their battery capacity by size segment and reflects on-road driving conditions. See [Annex B for definition of car size groups](#) and [Annex C](#) for more details on on-road electric ranges.

Sources: IEA analysis based on data from [EV Volumes](#), [European Environmental Agency](#), [US Environmental Protection Agency](#), [China, Ministry of Industry and Information Technology](#), and [S&P Global Mobility](#).

Extending vehicle range by increasing battery capacity involves trade-offs. Larger battery packs can increase vehicle weight, partly offsetting gains in range, and cost. As charging infrastructure expands and fast-charging battery capabilities improve, incremental increases in battery size yield diminishing returns.

## Today's average range can accommodate the vast majority of daily driving needs

In many markets, average daily driving distances are around 40 km,<sup>9</sup> equivalent to roughly one-tenth of the average battery electric car range. Daily driving needs are higher in some markets – for example, the average daily driving distance in the United States is around 65 km. Even for more intensive use cases, battery electric car ranges are sufficient for daily needs. Taxi drivers' [typical](#) distances, which [average](#) between 150 and 250 km per day, are roughly half of the average battery electric car driving range.

**Figure 1.15 Distribution of the range of battery electric car models, 2025**

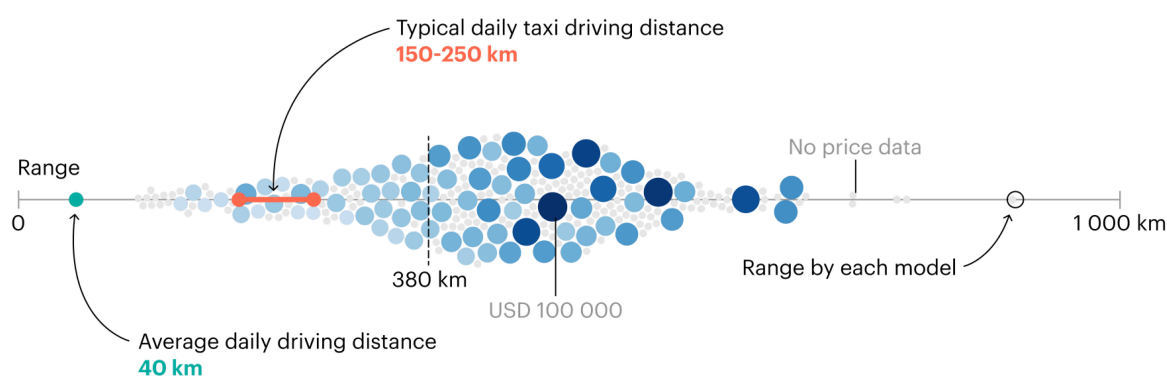

IEA. CC BY 4.0.

Notes: Each dot represents a battery electric car model available in 2025, positioned according to its driving range (km), along the horizontal axis. Dot size and shading reflect the relative price level (MSRP) of the model, with larger and darker dots indicating higher-priced models.

Source: IEA analysis based on data from [EV Volumes](#).

There is a clear relationship between battery electric car price and driving range. Lower-priced models generally have smaller batteries and thus offer shorter ranges, while longer-range vehicles tend to sit at the higher end of the price spectrum. Nevertheless, cost is not purely range-driven, as other features increasingly shape model positioning. In recent years, carmakers have also focused on software capabilities, charging speed and autonomous driving functions to attract new consumers (see [Chapter 8](#)).

<sup>9</sup> This is based on the global average annual kilometres travelled in 2025, divided by 365. The value has also been validated by country survey data, such as from [the US National Household Travel Survey](#), [Korea's Traffic Safety Information Management Complex System](#), the [Australian Bureau of Statistics](#) and [Statistics Netherlands](#).

Are electric cars suitable for long road trips?

Among the many factors that consumers weigh up when considering switching to an electric car, the question of whether they can use it for occasional long-distance trips looms large. In 2025, the average on-road range of battery electric cars was close to 400 km, and some models available today offer more than 600 km, although they typically cost more. Electric car buyers must decide how much extra driving range is worth paying for, and how willing they are to rely on fast chargers along highways.

Driving on highways reduces electric vehicle (EV) efficiency, meaning that a battery electric car with a 400 km on-road range can typically cover around 320 km on its first leg, when starting from a full charge and stopping at 10% state of charge. That equates to a driving time of almost three hours at an average of 110 km/h. A 25-minute stop at a 150-kW charger can add over 200 km of range in highway conditions, equivalent to 2 hours of driving. Using a 250-kW charger increases this to over 250 km, or two-and-a-half hours of driving time. The latest technologies have reached megawatt levels, enabling full battery recharge in less than 10 minutes, although this places greater stress on the grid.

Sufficient charging infrastructure is essential for long-distance trips. Fortunately, the number of ultra-fast chargers (with power ratings of 150 kW or above) has been growing in recent years. Today, they represent close to 15% of global public charging points. However, the location and the reliability of these chargers are also important. In the European Union, close to 60% of highways had at least one ultra-fast charger every 50 km in 2024. In the United States and Canada, coverage was lower, reaching only around 30% and 15% of highways, respectively. As ultra-fast charger deployment increased by 30% in these regions in 2025, the share of highways covered is also likely to have increased. Despite progress in major markets and along key corridors, continued investment and policy support remain important for making long-distance road trips in EVs even more convenient.

SHARE OF HIGHWAYS WITH AT LEAST ONE ULTRA-FAST CHARGER EVERY 50 KM IN SELECTED LOCATIONS, 2024

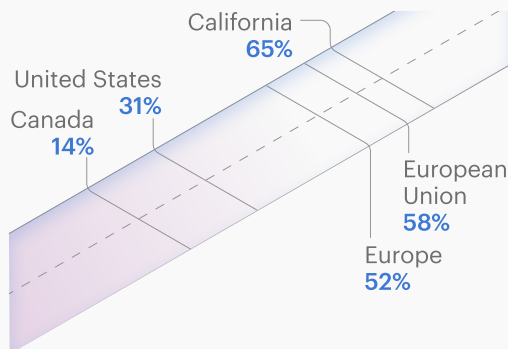

In addition to accelerating ultra-fast charger deployment, policy makers can strengthen consumer confidence by improving the information available to EV drivers. Requiring manufacturers to report real-world ranges for both city and highway conditions, as well as over mixed driving cycles, would give drivers a clearer understanding of vehicle performance during long-distance travel, so that they can plan accordingly. Reporting performance losses in cold climates – with real-world measurements typically showing between 20% and 40% range loss in cold winter conditions – would further support effective planning.

ADDITIONAL HIGHWAY RANGE AND DRIVING TIME PER CHARGING SESSION FOR A 400 KM MIXED-CYCLE (CITY AND HIGHWAYS) CAR, BY CHARGING POWER, 2025

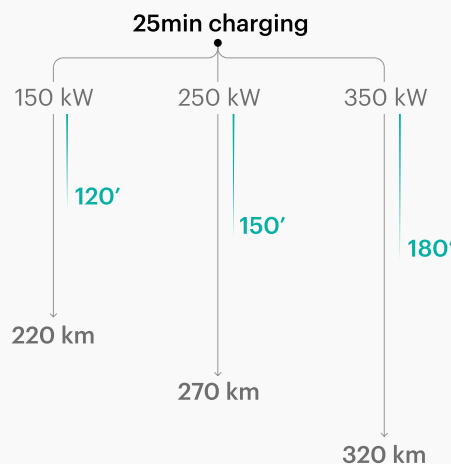

## 2026 sales trends

### Global electric car sales fell in the first quarter of 2026, despite record-breaking March sales in several countries

Europe saw electric car sales increase 30% in the first quarter, while sales in other major EV markets declined

Electric car sales in the first quarter (Q1) of 2026 reached approximately 3.9 million globally, 8% lower than the same period last year, marking the first year since 2020 in which Q1 sales were down year-on-year. The decline in sales was driven primarily by lower sales in China, as well as the United States; meanwhile sales grew year-on-year in Europe and the rest of the world. In March 2026, global electric car sales rebounded close to March 2025 levels.

Figure 1.16 Quarterly electric car sales by region, 2024-2026

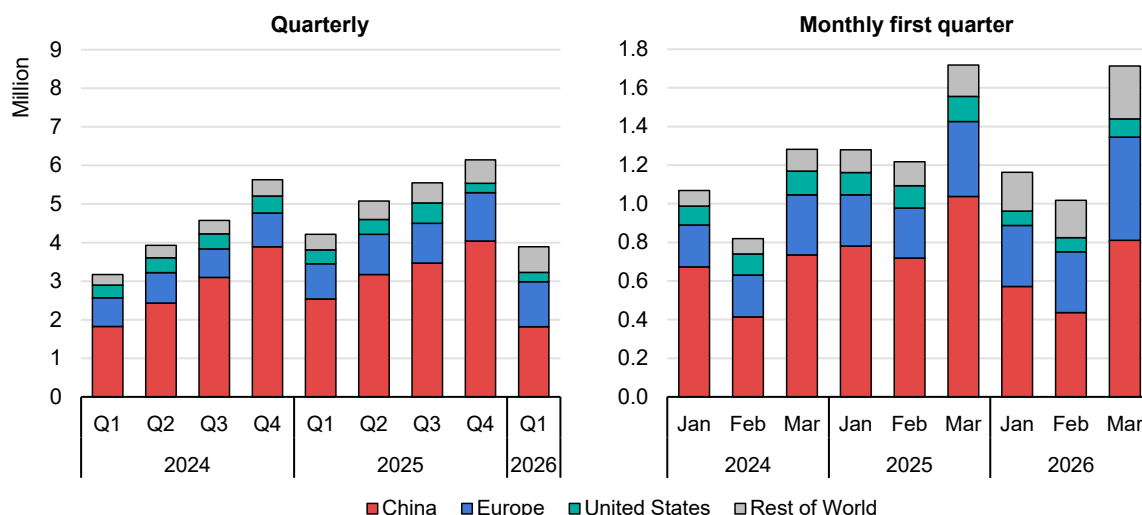

IEA. CC BY 4.0.

Note: Q = quarter.

Sources: IEA analysis based on data from [EV Volumes](#) and [ACEA](#).

The drop in global sales was primarily due to the more than 20% decline in Q1 electric car sales in **China** when compared to Q1 2025. This downturn reflects a combination of policy changes impacting the purchase price of electric cars. Firstly, the government trade-in scheme has been revised so that the subsidy amount is now set as a share of the vehicle purchase price, effectively reducing the amount of purchase subsidy that most electric cars are eligible for, and secondly, purchase tax has been reintroduced (5% in 2026) for electric cars. Together these two policies mean that electric cars are costing consumers more, especially the most affordable electric cars. For example, in 2025, a battery

electric car with a sticker price of USD 15 000 could be purchased in China for USD 12 000, if a less-efficient ICE car was being traded in; in 2026 this same upgrade would cost the buyer close to USD 14 000 (15% more). Considering that small electric cars are around 60% cheaper than the average small ICE car in China, and have come to dominate that segment in China, the effective price increase for EVs at the beginning of 2026 is likely to have pulled forward some purchases to the end of December 2025, and to be delaying car purchases for the most price-sensitive consumers in 2026.

Importantly, the overall car market in China contracted in the first few months of 2026, despite a reported 5% year-on-year growth in GDP during the first quarter. Q1 car sales in China were down [around 20%](#) year-on-year, which meant that the sales share of electric cars was somewhat protected despite the decline in sales volumes. In March, following the Chinese New Year holiday period, sales of both electric cars and cars overall rebounded closer to March 2025 levels, though still remained around 15% lower year-on-year. In April 2026, electric cars grew to [over 60%](#) of total car sales, while total car sales were down 20% year-on-year. Although domestic electric car sales are down in China, exports more than doubled year-on-year during the first quarter of 2026.

Across **Europe**, Q1 2026 sales grew almost 30% year-on-year, reaching around 1.2 million, with about 250 000 more cars sold than in Q1 2025. In particular, Europe saw March 2026 electric car sales reach almost 40% higher than in March 2025 and 70% higher than February 2026. Major markets such as Germany, France, Italy, Spain and the United Kingdom all posted robust gains, with some reaching record monthly sales. Growth has been supported by tightening CO<sub>2</sub> emissions standards and zero-emission vehicle mandates, persistently high gasoline prices, the reintroduction of consumer incentives, and the increasing availability of more affordable EV models, including those from Chinese manufacturers. Preliminary sales data for April 2026 indicate year-on-year growth of around 25%.

In particular, Germany constituted almost one-quarter of the European Q1 2026 electric car sales growth, partly thanks to the reintroduction of purchase subsidies at the beginning of the year, which helped drive first quarter sales up 35% year-on-year. Electric car sales in Germany reached record heights in March 2026, totalling 100 000, more than 45% higher than March 2025 sales. While sales in April fell slightly, around one in three cars sold across the first four months of 2026 was electric, up from around 27% during the same period in 2025. First quarter sales in the United Kingdom were up 25% year-on-year, with March 2026 sales reaching an all-time high of over 130 000. Chinese imports to the United Kingdom represented around 35% of electric car sales, up from less than 30% during 2025. Similarly, in Italy, Q1 2026 electric car sales were up almost 90% year over year, with March 2026 sales reaching a record of more than 30 000 in one month, with

a slight increase in the share produced in China. Although March 2026 sales did not break records in France, the country saw sales grow 40% year-on-year in the first quarter of 2026, and the share of Chinese imports in electric car sales fell to around 10%.

In the **United States**, Q1 2026 electric car sales were a third lower than sales in Q1 2025, reflecting the ending of federal tax credits after Q3 2025. March 2026 sales reached the highest level since the tax credits ended, at around 95 000, though still around 30% lower than sales recorded in March 2025. From the end of Q2 2025 through April 2026, electric cars have represented 6-7% of total car sales in the United States.

Across the rest of the world, Q1 2026 sales reached more than 650 000, up almost 70% compared to the same period of 2025. Most of these sales took place in EMDEs other than China.

### First quarter electric car sales grew close to 80% year-on-year across Asia Pacific countries other than China

Around 450 000 electric cars were sold in Q1 2026 across Asia Pacific countries other than China, up 80% year over year. In particular, almost 200 000 electric cars were sold in **Southeast Asia** during the first quarter of 2026, 80% higher than sales during Q1 2025. About 60% of the electric cars sold in Southeast Asia during Q1 2026 were imported from China, up from about 50% across 2025, despite a number of countries ending import tariff exemptions from 2026. Of course, some of this growth may have been the result of selling down inventories of Chinese imports that had built up in 2025.

**Thailand** alone was responsible for over 60 000 electric car sales during Q1 2026, with January 2026 breaking records – reaching three times the sales of the previous best-selling month. Sales of electric cars in **Viet Nam** exceeded 50 000 in Q1 2026, up around 50% year-on-year. **Indonesia** saw Q1 2026 sales grow almost 90% compared to Q1 2025 sales, exceeding 30 000; preliminary data indicates this year-on-year growth was sustained through April.

**Figure 1.17 First quarter electric car year-on-year sales growth for selected Asia Pacific countries, 2026**

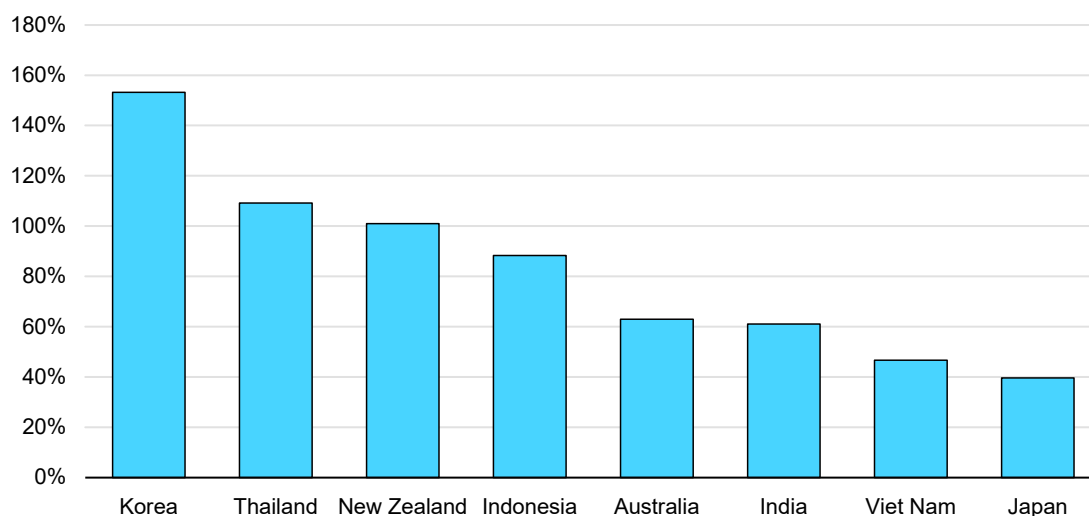

IEA. CC BY 4.0.

Source: IEA analysis based on data from [EV Volumes](#).

**Korea** saw electric car sales grow 2.5-fold during the first quarter of 2026 compared to Q1 2025, reaching a total of around 85 000. Sales in March 2026 hit a monthly high of around 40 000. Across Q1 2026, electric cars represented around 20% of total car sales, up from 11% across 2025.

In **India**, electric car sales grew 65% year over year during the first quarter of 2026, to reach over 55 000. In April, electric car sales volumes did not change significantly month-on-month, but were up 90% year-on-year. Across the first four months of 2026, the electric car sales share in India increased only slightly to around 4.5% of total car sales, up from just under 4% across 2025.

In **New Zealand**, electric car sales doubled year-on-year across the first quarter of 2026. March sales were particularly strong – three-and-a-half times the number in March 2025. In **Australia**, March 2026 represented all-time high monthly electric car sales, at 20% higher than the previous best-selling month. As a result, Q1 2026 sales of electric cars were up around 65% year over year in Australia.

In **Japan**, subsidy levels were revised at the beginning of the year, increasing the maximum subsidy available for electric cars. As a result, electric car sales grew 40% over the first quarter of 2026 compared to sales in the first quarter of 2025. In March, electric car sales hit an all-time high in the country, reaching close to 18 000. This growth has pushed sales shares above the levels observed in 2025.

## Electric car sales were up 75% year-on-year across Latin America in the first quarter of 2026

Electric car sales in **Brazil** were up around 85% in the first quarter of 2026 compared to the same period the year before. In March 2026, sales exceeded 26 000, slightly higher than the previous monthly record high of December 2025, and April sales grew a further 15% month-on-month. Despite the phase-out of import tariff exemptions at the end of 2025, Chinese-made electric cars continued to make up roughly 85% of sales in Brazil during Q1 2026, though it is likely that a share of these cars arrived in the country before the end of 2025.

In **Mexico**, EV sales rose by around 15% in the first quarter of 2026, with PHEVs remaining dominant. Sales in both Colombia and Chile more than doubled in Q1 2026, but their combined sales – less than 15 000 – remain lower than the volumes sold in Mexico or Brazil, given the small overall car markets. Across Latin America, the share of Chinese imports in electric car sales remained steady during the first quarter of 2026, at around 85%.

## Electric car sales are expected to grow 10% in 2026, but uncertainties are high

Market and policy fundamentals for 2026 point towards growth in electric car sales, but data on low sales figures in the first quarter of 2026 suggest that the rate of growth is likely to be more moderate than previously expected. China has scaled back incentives, and in the United States, manufacturers are reassessing electrification strategies. In Europe and Southeast Asia, demand is being driven by a combination of policy action and the improving affordability of electric cars. Overall, global electric car sales are expected to reach around 23 million, representing growth of approximately **10%**.

However, uncertainties around dynamics in the electric car market are currently very high, including those related to changing fuel prices. For example, based on higher gasoline prices since the start of the conflict in the Middle East, the average driver in Australia could save an additional USD 490 per year by choosing an electric car instead of an ICE one. There are already some preliminary signs of higher year-on-year sales in April in countries that have experienced very large gasoline price hikes – such as Australia (+34% gasoline prices; +180% electric car sales) and New Zealand (+31% gasoline prices; +195% electric car sales) – as well as in countries with electric car price parity such as Viet Nam (+90% electric car sales). Yet uncertainty also applies in the other direction: for example, if more governments implement fuel tax reductions or fuel subsidies, drivers would be less affected by increased oil prices. Equally, a more rapid return to a lower price environment, or a sharp increase in electricity prices, would weaken this additional incentive to purchase electric cars.

The conflict in the Middle East is also set to have consequences on economic activity in 2026, although the extent of these is still unclear. The [International Monetary Fund's April World Economic Outlook](#) reference forecast has already incorporated a 0.3 percentage point reduction in 2026 global growth relative to its pre-conflict forecast, from 3.4% to 3.1%. In its severe downside scenario, global growth could be reduced by a further 1.3 percentage points in 2026, bringing it to around 2% – a level the IMF describes as a “close call for a global recession.” Global economic growth of less than 2% has occurred only four times since 1980.

The economic impacts of the crisis have the potential to significantly affect the overall car market. In the past, economic downturns and recessions have been correlated with rapidly declining car sales, as consumers see their spending power weaken or decide to delay purchases due to low confidence in future earnings. For example, pronounced and abrupt economic crises have led to double-digit declines in car sales in the past, for example, in the United States between 2007 and 2009 (GDP -2.5%, car sales -37%) and in Italy between 2011 and 2013 (GDP -5%, car sales -25%). Electric car sales could be disproportionately affected by this trend in regions where price parity has not yet been reached, as lower consumer confidence could result in budgetary constraints that limit ability to purchase vehicles with a higher price, even if they yield running cost savings.

Energy crises have, in multiple instances, spurred government action to reduce dependencies on the fuels affected. The 1973 oil crisis marked the introduction of fuel economy standards which contributed to curbing oil demand in the medium to longer term. Large-scale policy action usually has longer lead times. However, the severity of the disruption, as well as the availability of regulatory frameworks in many countries, might lead to rapid policy action incentivising electric car sales. These could include pauses of import tariff duties to get access to low-priced electric cars or temporary additional incentives for electric cars. If policy responses follow this direction, sales of electric cars could significantly accelerate.

## Strong growth expected in Europe and emerging markets in 2026

In **China**, the world's largest EV market, sales are expected to reach **more than 14 million**, growing by close to **8% year-on-year**. This level of growth reflects weaker performance in the early months of the year, partly driven by the introduction of caps to trade-in incentives ([scrappage schemes](#)). At the same time, long-standing [purchase tax exemptions](#) for new energy vehicles (NEVs) are being phased out (see [Q1 sales](#)). However, the market share of electric cars is expected to grow to close to 60%, despite a weak overall car market, supported by a highly competitive domestic industry and extensive model availability.

In **Europe**, electric car sales are set to maintain robust momentum in 2026. Policy support is strengthening in key markets, with Germany reintroducing incentives and Spain advancing its Plan Auto+ programme. In the United Kingdom, the mandated share of zero-emission vehicles rises to 33% under the [Vehicle Emissions Trading Schemes](#), up from 28% in 2025. At the same time, increased competition, including from Chinese manufacturers, is expanding consumer choice, particularly in more affordable segments. As a result, European EV sales are expected to reach 5 million, marking an increase of close to 20%.

In the **United States**, the EV market is facing challenges. Sales in 2025 were already impacted by the end of federal tax credits and a strategic pullback by automakers from electrification timelines. Nevertheless, the sales share of electric cars in the United States is expected to grow over the second half of the year to reach around 8% across 2026, down from close to 10% in 2025. As a result, electric car sales reach around 1.2 million, representing a decline of over 20%.

By contrast, **emerging EV markets** are becoming a major new engine of growth. Supported by improving affordability, expanding model availability, and strengthening policy frameworks, EV adoption is accelerating rapidly across several regions. In 2026, total electric car sales in these markets are expected to reach almost 3 million, an increase of close to 50%. Southeast Asia is set to reach 0.8 million sales, Latin America 0.5 million, and India over 0.2 million. Strong uptake is being driven by competitively priced vehicles, particularly from Chinese OEMs, alongside high fuel prices and increasingly comprehensive policy support, including incentives, tax exemptions, and broader EV ecosystem development strategies (i.e. Thailand and Indonesia).

# Chapter 2. Trends in electric car prices

## New electric car prices

### Electric car prices fell in major markets, but the lack of low-cost models still limits affordability in some

The upfront price of electric cars compared to their internal combustion engine (ICE) equivalents remains a barrier to wider adoption. Over the past decade, declining battery manufacturing costs and the introduction of new affordable models mean the price-competitiveness of electric cars has made significant strides. However, the shift towards larger batteries and larger vehicle segments in many markets over the past 5 years has limited the impact of these cost reductions on purchase prices.

**Figure 2.1 Battery electric car price changes by contributing factor and segment in China, Germany and the United States, 2024-2025**

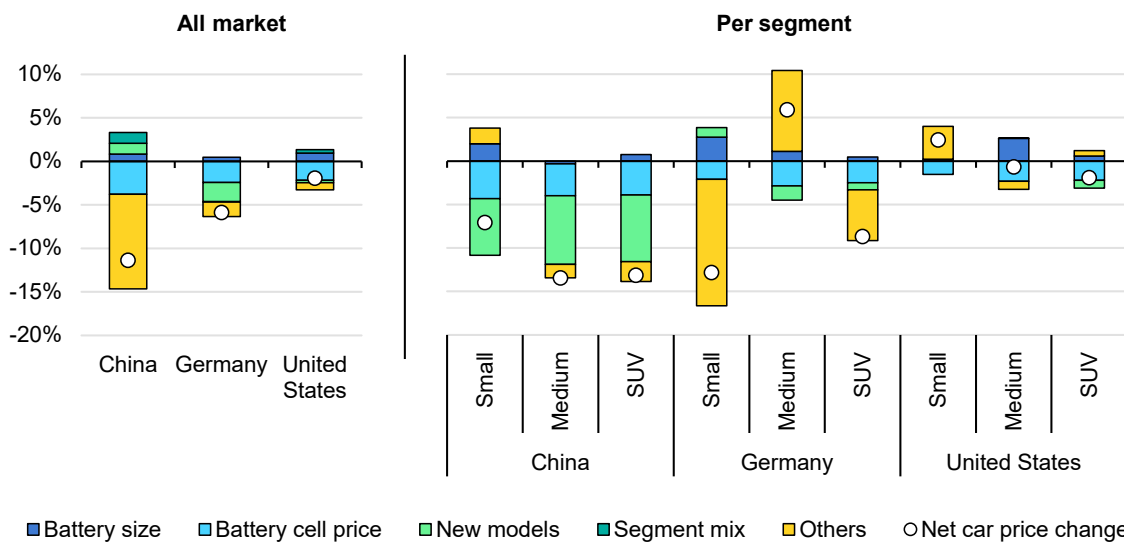

IEA. CC BY 4.0.

Notes: Prices are adjusted for inflation using regional consumer price indices. The figure shows sales-weighted average prices. The impact of changes in battery pack size, battery pack price, segment-size mix, and the introduction of new models on the average battery electric car price is shown. "Others" captures price changes resulting from carmakers' pricing strategies, non-battery component cost changes and within-model shifts across incumbent trims.

Sources: IEA analysis based on [EV Volumes](#) for the battery size, [BNEF](#) for the battery price, [S&P Global Mobility](#) for car price data and [World Bank](#) for consumer price indices.

In 2025, the sales-weighted average purchase price<sup>10</sup> of electric cars declined across almost all segments across the three markets covered in this section – the People’s Republic of China (hereafter, “China”), Germany and the United States. Across all three, a decrease in battery cell prices and manufacturers’ pricing strategies contributed to cost declines, although new model entries in each market had differing effects on average battery electric vehicle (BEV) prices.

In **China**, while prices fell within most segments, the introduction of new models put upward pressure on average BEV prices, as many of these were SUVs. The rising share of SUVs and increasing average battery sizes would have led to a roughly 3% increase in prices, but this effect was more than offset by declining battery cell prices (Figure 5.4), as well as non-battery component cost declines and carmakers’ aggressive pricing strategies in the increasingly [competitive](#) electric vehicle (EV) market. The overall result was a net drop of more than 10% in average BEV prices in 2025.

In **Germany**, the introduction of new affordable models brought down the average BEV price in 2025, even though the price of medium-sized models actually rose. New affordable models and battery cost declines together reduced the average BEV price by around 5%, with pricing strategies and other factors bringing the total year-on-year decrease to about 6%.

In the **United States**, the average retail price of a battery electric car fell nearly 2% in 2025. Most of the price decline can be explained by battery price reductions, while the remainder was driven by pricing strategies and non-battery manufacturing cost changes.

Progress in electric car affordability is also reflected in the distribution of base model prices relative to ICE vehicles. In **China**, around 30% of battery electric car models had an entry-level price below USD 20 000 in 2025. While still almost 10 percentage points lower than the share of ICE cars below this threshold, this marked a more than 5-percentage-point increase from the previous year. In **Europe**, affordability gaps remain wider: In 2025, about 25% of ICE models were priced below USD 30 000 compared with less than 10% of battery electric models (a small increase on the roughly 5% in 2024). In the **United States**, limited availability of lower-cost models continues to weigh on EV price-competitiveness. In both 2024 and 2025, less than 20% of available electric car models had a base

---

<sup>10</sup> “Price” refers to the manufacturer suggested retail price (MSRP), also known as the sticker price, which includes VAT, purchase taxes and dealer mark-ups, but excludes purchase subsidies and registration taxes. It differs from the transaction price in that it does not account for any rebates and discounts applied at the dealership.

trim price tag below the median price paid for an ICE car (approximately USD 40 000), compared with more than 40% of ICE models.

**Figure 2.2 Price range distribution of available car models in selected markets, 2024-2025**

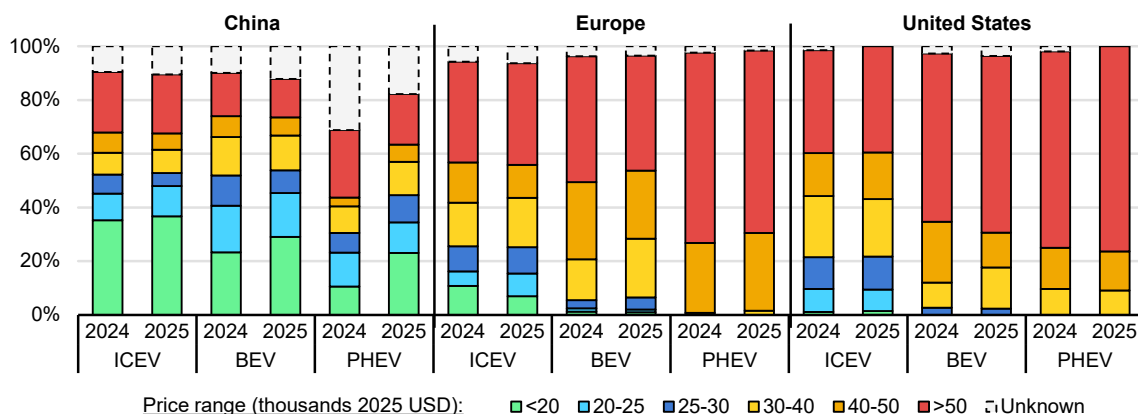

IEA. CC BY 4.0.

Notes: ICEV = internal combustion engine vehicle; PHEV = plug-in hybrid electric vehicle; BEV = battery electric vehicle. Prices are adjusted for inflation using regional consumer price indices. Germany, the United Kingdom and Türkiye are used as proxy countries for available models in Europe. Within each make-model group, the lowest-priced trim is considered to represent the base model entry price.

Source: IEA analysis based on data from [S&P Global Mobility](#) and [World Bank](#) for consumer price indices.

Progress in electric car affordability is also reflected in the distribution of base model prices relative to ICE vehicles. In **China**, around 30% of battery electric car models had an entry-level price below USD 20 000 in 2025. While still almost 10 percentage points lower than the share of ICE cars below this threshold, this marked a more than 5-percentage-point increase from the previous year. In **Europe**, affordability gaps remain wider: In 2025, about 25% of ICE models were priced below USD 30 000 compared with less than 10% of battery electric models (a small increase on the roughly 5% in 2024). In the **United States**, limited availability of lower-cost models continues to weigh on EV price-competitiveness. In both 2024 and 2025, less than 20% of available electric car models had a base trim price tag below the median price paid for an ICE car (approximately USD 40 000), compared with more than 40% of ICE models.

## In China, the price-competitiveness of electric cars continued to grow

In China, the price-competitiveness of electric cars made major progress in all segments. Most noticeably, the affordability of small electric models displaced essentially all ICE alternatives in the small-sized car market in 2025.

Medium-sized cars, accounting for nearly 30% of new car sales, remained the most difficult segment to electrify. Their diverse uses, from daily commuting to longer-distance travel, limit opportunities for cost reductions through smaller batteries, while their market positioning constrains the ability to justify higher price premiums, unlike larger SUVs. Despite this, their relative affordability improved significantly in 2025, with the average price premium paid for a battery electric model falling below 15%, down from about 20% the previous year. As a result, electric models exceeded a 40% sales share in this segment, although this remained the lowest adoption rate across all car sizes in China.

In the SUV segment, which accounted for almost half of all car sales in 2025, BEVs reached price parity with ICE models for the first time. Plug-in hybrid SUVs remained cheaper than their ICE equivalents, although extended-range electric SUVs continued to sell at a roughly 60% premium, reflecting their higher-end positioning. Improved price-competitiveness contributed to rapid electrification in this segment, with adoption rates over 55% in 2025, albeit contributing to the shift of Chinese electric cars towards larger and heavier vehicles.

Looking ahead, intense price competition in China's electric car market is likely to persist. In 2026, tighter policy support – including reduced purchase tax exemptions and stricter trade-in incentives – is expected to increase price pressure on carmakers. However, in most cases, affordability is no longer dependent on policy support: in 2025, even before government incentives, nearly 70% of BEVs sold in China were already cheaper than their ICE equivalents, up from around 50% in 2021.

**Figure 2.3 Electric car price premium compared to conventional models (left), powertrain sales shares (centre) and sales share of battery electric vehicles cheaper than conventional equivalents (right) per segment in China, 2021-2025**

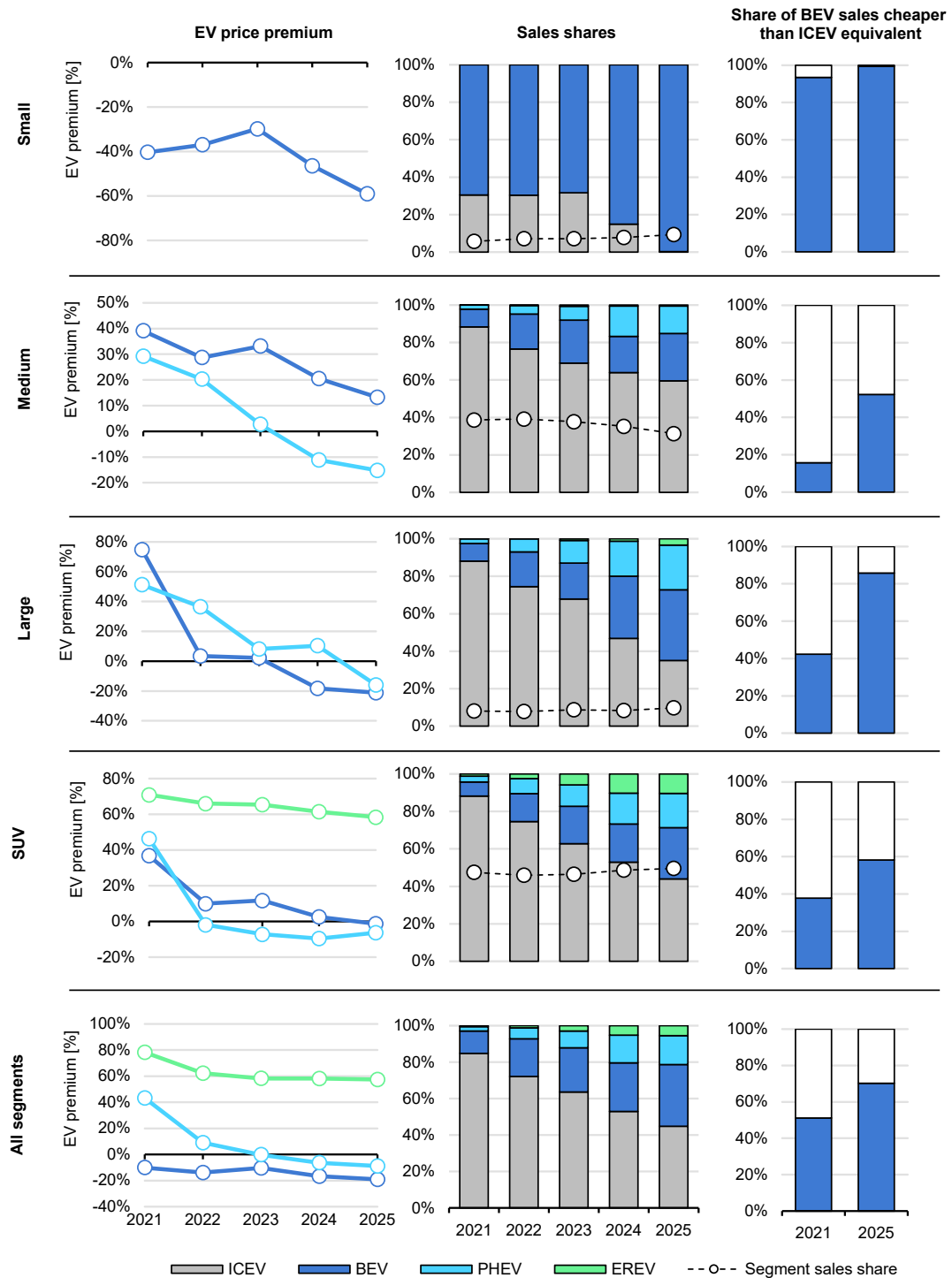

IEA. CC BY 4.0.

Notes: EV = electric vehicle; BEV = battery electric vehicle; ICEV = internal combustion engine vehicle; PHEV = plug-in hybrid electric vehicle; EREV = extended-range electric vehicle. Price of electric cars in data has been increased by 10% to adjust for the registration tax exemption in China. The share of battery electric cars cheaper than their conventional (ICE) equivalents is calculated as the number of car sales priced lower than the sales-weighted average price of the ICE car in their segment category.

Sources: IEA analysis based on data from [S&P Global Mobility](#), [EV Volumes](#) and [Marklines](#).

## In Europe, new model releases and pricing strategies cut electric car prices after years of increases

In **Europe**, affordability remains the most cited barrier to wider adoption: A 2025 [survey](#) of 3 000 EU citizens revealed that many consumers would not be willing to pay more for a BEV than a comparable ICE model. While fewer than 10% of available BEV models in Europe were priced under EUR 30 000, the survey highlighted a willingness-to-pay a median price of around EUR 20 000.

**Figure 2.4** Decomposition of average battery electric car price changes in selected European countries between 2021, 2024 and 2025

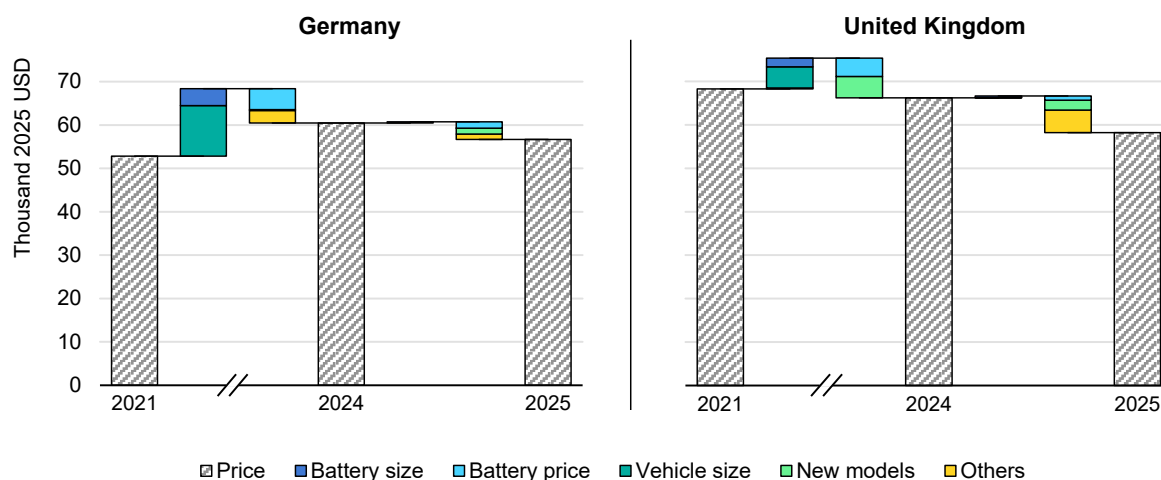

IEA. CC BY 4.0.

Notes: Prices are adjusted for inflation using regional consumer price indices. The impact of changes in battery pack size, battery pack price, segment-size mix, and the introduction of new models on the average battery electric car price is shown. "Others" includes changes due to carmakers' pricing strategies, non-battery component cost changes and within-model shifts across incumbent trims.

Sources: IEA analysis based on [EV Volumes](#) for the battery size, [BNEF](#) for the battery price, [S&P Global Mobility](#) for car price data and [World Bank](#) for consumer price indices.

The affordability of electric models made substantial progress in Europe in 2025, with the average price of battery electric cars [decreasing](#) for the first time following years of increases. The EU CO<sub>2</sub> standards' 2025 target pushed carmakers to introduce more affordable models to the market, such as the Renault 5 E-Tech, the Hyundai Inster, Tesla's Model 3 and Model Y (with standard [trims](#)), and new Chinese models hit the European market. As a result, in Germany and the United Kingdom, the larger range of model and trim offerings explained about one-third of the year-on-year price decline observed in 2025. The remainder can be explained by the decrease in battery prices and other factors such as original equipment makers (OEMs)' pricing strategies. However, this price drop would have been more pronounced had there not been a concurrent shift to larger and heavier models. In 2025, the average retail price of battery electric cars would have been roughly 20% lower in Germany and more than 5% lower in the United Kingdom without the increasing transition to SUVs and larger models that has taken place since 2021.

**Figure 2.5 Electric car price premium compared to conventional models (left), powertrain sales shares (centre) and sales share of battery electric vehicles cheaper than conventional equivalents (right) per segment in Germany, 2021-2025**

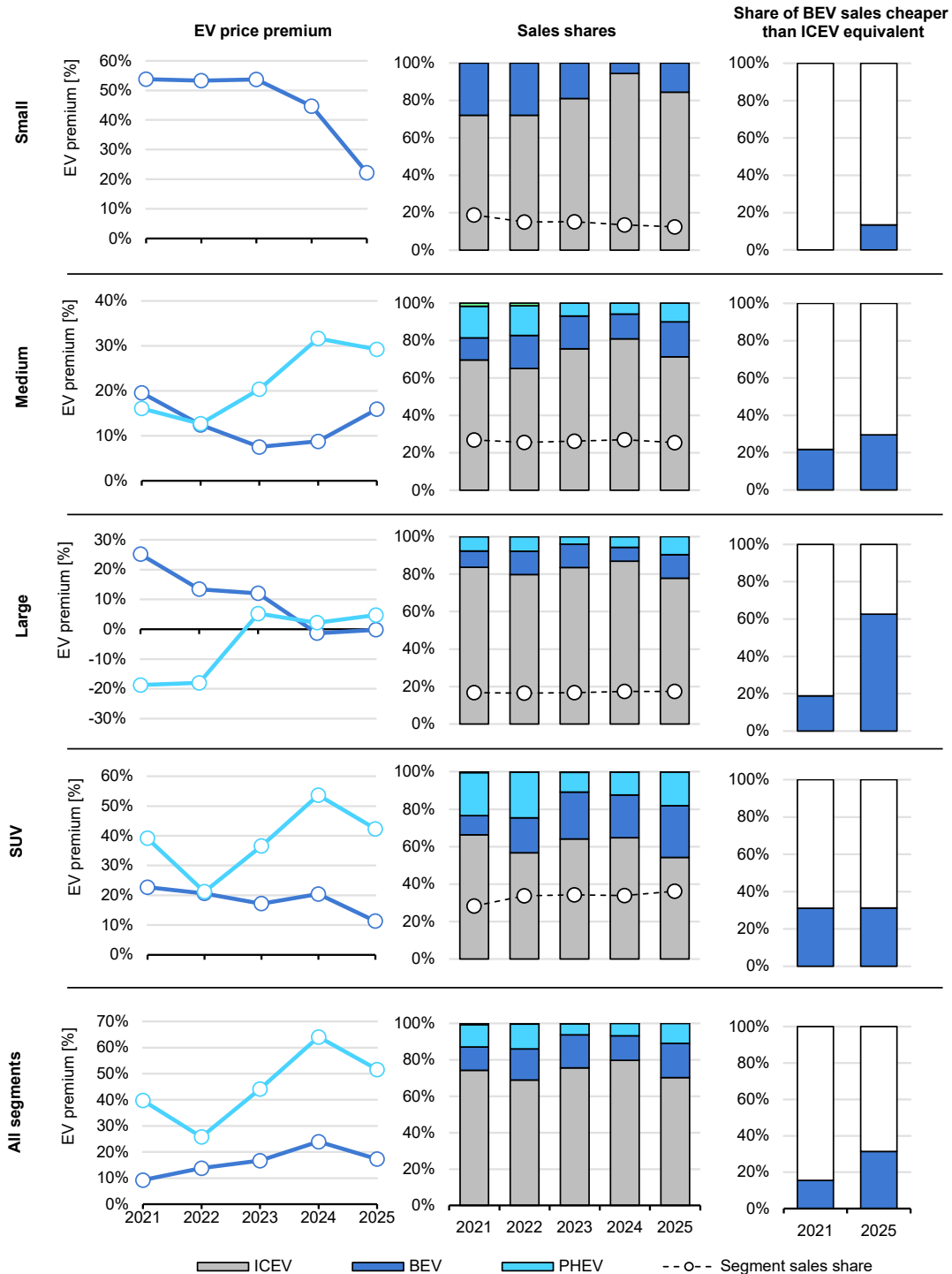

IEA. CC BY 4.0.

Notes: EV = electric vehicle; ICEV = internal combustion engine vehicle; BEV = battery electric vehicle; PHEV = plug-in hybrid electric vehicle. The share of battery electric cars cheaper than their conventional (ICE) equivalent is calculated as the number of car sales priced lower than the sales-weighted average price of the ICE car in their segment category.

Sources: IEA analysis based on data from [S&P Global Mobility](#), [EV Volumes](#) and [Marklines](#).

In **Germany**, the average price premium for small battery electric cars declined markedly in 2025, falling to around 20%, down from the 50% premium observed between 2021 and 2025. Strong sales of existing models such as the Fiat 500, alongside new, more affordable entries like the Renault 5 E-Tech, Leapmotor T03 and the BYD Dolphin, supported the first increase in electric car sales shares within the small segment since 2021, although the 2025 share was still lower than levels seen 3 years earlier, at less than 15%.

In contrast, medium-sized BEVs were sold at an average premium of around 15% relative to medium-sized ICE models, more than 5 percentage points higher than in 2024, making this segment comparatively less competitive.

In the SUV segment, which represented over 35% of total car sales in 2025, BEV price-competitiveness improved noticeably. The average price premium declined to around 10%, down from about 20% the previous year.

Overall, battery electric SUVs and small cars were the main contributors to improved affordability in 2025. Across all segments, the average BEV price premium declined for the first time since 2021 to around 20%, although remained higher than 2021 levels. At the same time, the share of BEVs sold below the average price tag of their ICE equivalents surpassed 30% in 2025, up from about 15% in 2021. This highlights significant within-segment affordability gains, partly offset by a continued shift towards larger, more expensive electric car segments.

## In the United States, carmakers slashed EV prices amid a cooldown in demand

In the **United States**, SUVs represented more than three-quarters of both new ICE and new electric car sales in 2025, highlighting the importance of this segment for the average price-competitiveness of electric cars.

Following the end of federal EV tax credits in October 2025, Tesla rolled out lower-priced “standard” [trims](#) of the Model Y and Model 3, contributing to the modest progress in the average price-competitiveness seen in 2025. A number of other carmakers followed suit and slashed the prices of their existing electric models. In 2025, there were nearly 20 models with entry-level prices below USD 40 000, compared to fewer than 15 the year before.

In 2025, the price premium paid for a battery electric SUV stood under 25%, a nearly 5 percentage point decrease from the previous year. As a result, more than 30% of battery electric SUV sales undercut the average ICE SUV in 2025, up from 20% the year before and less than 10% in 2021. Looking forward, as reflected in Hyundai’s significant [discounts](#) in early 2026, price cuts to mass-market electric models are likely to continue in 2026 in the absence of the federal EV tax credit to reduce EV price premiums.

**Figure 2.6 Electric car price premium compared to conventional models (left), powertrain sales shares (centre) and sales share of battery electric vehicles cheaper than conventional equivalents (right) per segment in the United States, 2021-2025**

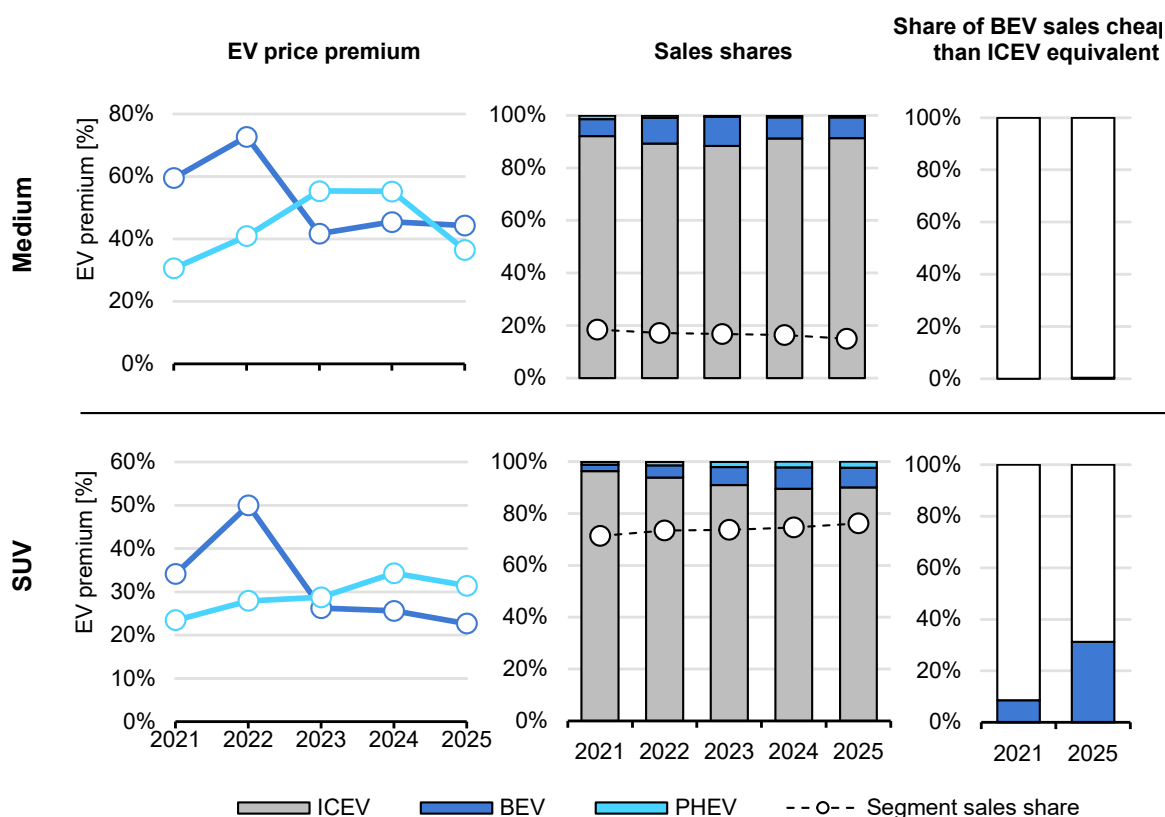

IEA. CC BY 4.0.

Notes: EV = electric vehicle; ICEV = internal combustion engine vehicle; BEV = battery electric vehicle; PHEV = plug-in hybrid electric vehicle. The share of battery electric cars cheaper than their conventional (ICE) equivalent is calculated as the number of car sales priced lower than the sales-weighted average price of ICE cars in their segment category.

Sources: IEA analysis based on data from [S&P Global Mobility](#), [EV Volumes](#) and [Marklines](#).

## In emerging markets, affordable Chinese models helped drive EV adoption

### In Southeast Asia, affordability improved with Chinese imports, but localisation will test cost-competitiveness

The affordability of electric cars in Southeast Asia continued to improve in 2025. In **Indonesia**, the average price premium of electric cars declined from 55% in 2024 to around 40% in 2025. This was primarily driven by the growing sales share of Chinese models – mostly imported from China and, to a lesser extent, from Thailand. Chinese models accounted for over 75% of electric car sales in Indonesia in 2025, up by around 20 percentage points from the previous year. The sales-weighted average price of Chinese battery electric cars was around 40% higher than the average price of ICE cars sold in 2025, in line with the overall

average price premium. Other manufacturers also contributed to improving affordability. Imports of VinFast electric cars from Viet Nam represented over 10% of sales and were priced, on average, about 15% lower than ICE cars in Indonesia. In the coming years, as Indonesia's policy framework shifts towards greater localisation – particularly following the expiry of import duty waivers in December 2025 – maintaining affordability gains will depend on whether the carmakers who invested in establishing local manufacturing facilities, such as BYD, Geely, Great Wall Motor and VinFast, can maintain their cost-competitiveness.

In **Thailand**, purchase price parity between battery electric and ICE models was already achieved in 2024. In 2025, as planned under the EV3.5 policy, EV import duty waivers expired, and foreign carmakers were required to ramp up local production to remain eligible for incentives. As a result, the share of Chinese-made EV imports in total electric car sales declined for the first time, falling from 80% to 75% year-on-year. This was partly offset by Chinese manufacturers increasing output from their local assembly plants. BYD, for example, shifted the production of Thailand's best-selling BEV model, the Dolphin (accounting for 10% of BEV sales in 2025) from China to its Thai facilities. Notably, the list [price](#) of the Dolphin fell from THB 700 000 (Thai baht) (around USD 20 000) in 2024 when primarily imported from China, to roughly [THB 640 000](#) (less than USD 18 500) in 2025.

**Figure 2.7 Average price premium of electric cars compared to internal combustion engine cars in selected emerging markets, 2024-2025**

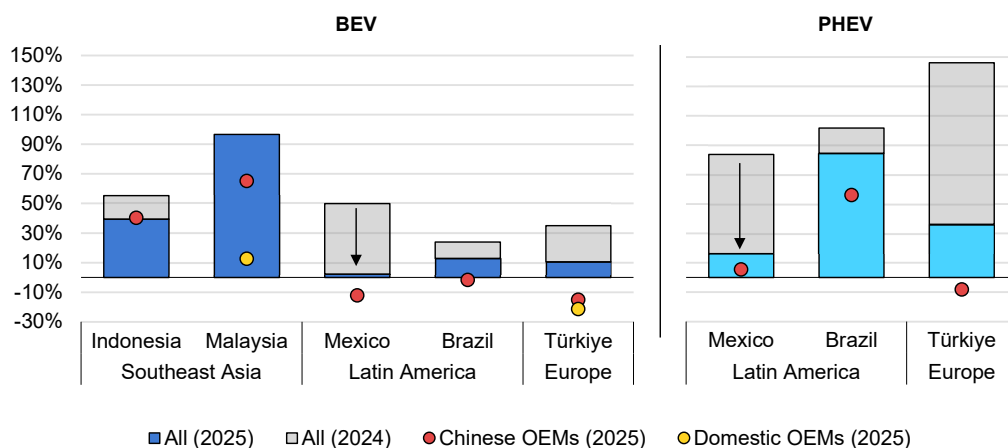

IEA. CC BY 4.0.

Notes: BEV = battery electric vehicle; PHEV = plug-in hybrid electric vehicle; OEM = original equipment manufacturer. 2024 price data for Malaysia was not available.

Source: IEA analysis based on data from [S&P Global Mobility](#).

In **Malaysia**, electric cars remained significantly more expensive than conventional models in 2025, with average prices roughly twice as high. This reflects the earlier stage of EV market development in the country, with the sales share at about 7%, compared with neighbouring countries such as Thailand and

Indonesia. Chinese models, which accounted for nearly 80% of EV sales, were priced at an average premium of around 65% relative to conventional cars, higher than the average price premium seen in Indonesia. More affordable options were primarily offered by domestic manufacturers. In 2025, mass-market models from Malaysia's Proton, the e.MAS5 and e.MAS7, sold at a premium of only around 10%, making them some of the most price-competitive EVs in the market, although they are essentially [rebadged](#) models from Geely assembled in China. As in Indonesia and Thailand, the expiry of import duty waivers is expected to put upward pressure on prices. In response, [Proton](#) and a [handful](#) of Chinese carmakers announced plans to localise production through completely knockdown kit (CKD) imports, which benefit from import duty exemptions. Expanding mass-market model offerings, both from domestic manufacturers and Chinese OEMs ramping up local assembly, will be key to improving affordability and supporting wider EV adoption in the country.

### In Latin America, imports helped narrow price gaps but new tariffs may reverse gains

In **Mexico**, the price-competitiveness of both battery electric and plug-in hybrid cars made remarkable progress in 2025, primarily driven by increased Chinese imports. Chinese-made model sales soared in 2025, accounting for over 80% and over 90% of battery electric and plug-in hybrid electric car sales, respectively. As a result, battery electric cars were almost priced on par with conventional models in 2025, and Chinese models retailed 10% cheaper than the average ICE car in Mexico. Similarly, the price premium of plug-in hybrid electric cars – representing nearly 60% of electric car sales in 2025 – stood around 15%, marking a roughly 70 percentage point decrease from 2024. Capturing over 70% of the EV market, [BYD](#) was the most popular EV maker in the country, offering the most affordable options in its line-up. However, recent trade policy developments may reverse affordability gains. In December 2025, the Mexican Senate [approved](#) new tariffs – coming into effect from January 1, 2026 – on the import of certain goods, including cars (for which tariffs are set to 50%), from countries that do not have a free-trade agreement with Mexico, including China.

In **Brazil**, the affordability of electric cars improved markedly. In 2025, the price premium for battery electric cars halved from its 2024 level, reaching just under 15%, while the premium for plug-in hybrid models – representing over 55% of electric car sales – declined by more than 15 percentage points to around 85%. This progress was largely driven by affordable Chinese imports. Chinese-made models accounted for over 90% of battery electric car sales and nearly 80% of plug-in hybrid sales. On average, Chinese battery electric models were priced slightly below ICE cars, while plug-in hybrids remained about 50% more expensive. As import duties are gradually [reinstated](#) on both completely built (CBU) and CKD units, sustaining these affordability levels will depend on whether

local production, particularly from BYD's and Great Wall Motor's assembly plants, can replicate the cost-competitiveness of previously imported models.

### In Türkiye, tax incentives, low-cost imports and competitive local production brought affordability gains

In **Türkiye**, a combination of affordable imports and growing domestic production drove down electric car prices, further supported by reduced registration tax (ÖTV) rates for electric cars (embedded in this section's car price data). In 2025, the average price premium for battery electric cars in Türkiye fell from over 30% in 2024 to around 10%. Chinese models, priced on average about 15% below ICE cars, accounted for roughly 10% of BEV sales. Models from domestic EV maker Togg were even more price competitive, at an average of 20% cheaper than conventional cars, helping Togg to capture more than one-fifth of the BEV market. Price-competitive imports from other countries in Europe also contributed to improving BEV affordability. Plug-in hybrids saw significant progress, with their price premium declining from over 140% in 2024 to around 35% in 2025. For this powertrain technology, affordable imports from China were the main driver of price reductions, accounting for nearly three-quarters of sales and priced, on average, about 10% below conventional cars. However, recent trade policy developments are set to put additional pressure on the affordability of imported electric cars. In September 2025, the Turkish government [introduced](#) additional duties of 30% on electric car imports from countries outside the European Union, extending earlier China-specific [tariffs](#) of 40% introduced in 2024.

## Resale value of used electric cars

### The used car market could provide an important avenue for affordability

#### The most common way to buy a car is second-hand

Second-hand markets play a central role in enabling mass-market adoption of electric cars. Most people do not buy new cars; instead, they buy used cars because upfront costs are lower, making car ownership more affordable. For example, across [Europe](#) around eight in ten people purchase their car second-hand, and this share rises to roughly nine in ten among low- and middle-income households.

Besides increasing affordability for individual owners, the second-hand car market is important for fleet operators and leasing companies, which purchase large volumes of new cars and rely on stable residual values to manage costs and risks. In general, the price of a lease is designed to account for the depreciation of a

vehicle over the typical [3-year](#) lease period. Predictable resale values for electric cars, on par with those of conventional cars, help stimulate new electric car registrations, support fleet turnover, and increase the supply of affordable used vehicles entering the market following their first lease.

Over the past few years, the share of electric cars in the second-hand market has grown steadily across major regions. Across China, five key European markets (France, Germany, Italy, Spain and United Kingdom) and the United States, sales of used electric cars surpassed 3 million in 2025, an increase of around 35% compared with 2024.

**Figure 2.8 Sales and sales share of used electric cars in major markets, 2021-2025**

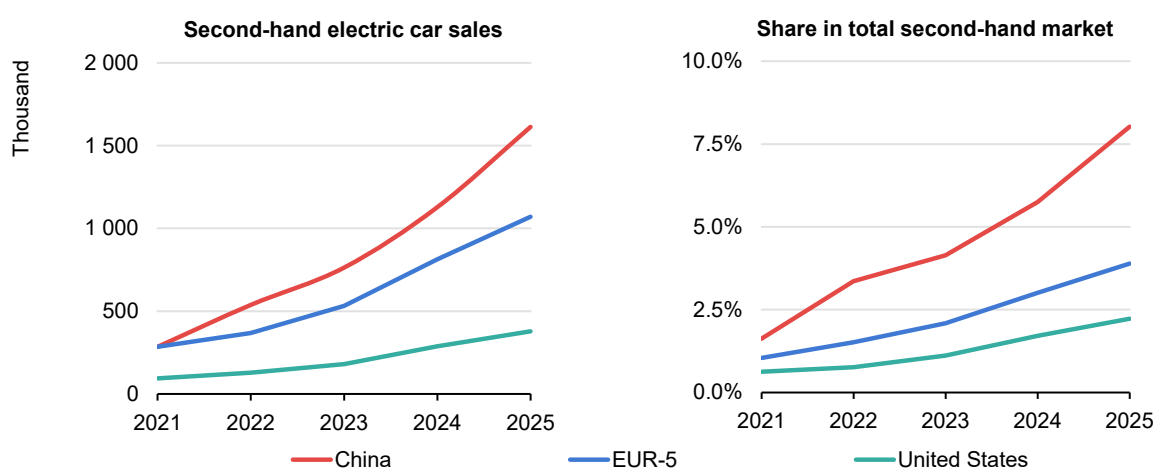

IEA. CC BY 4.0.

Note: EUR-5 = France, Germany, Italy, Spain and the United Kingdom.

Sources: IEA analysis based on [KBA](#), [ANFIA](#), [AAA-Data](#), [GANVAM](#), [SMMT](#), [Cox Automotive](#) and [CADA](#).

## Resale values in China are taking a hit from new, cheaper models

With around 13% of China's car fleet now electric, the second-hand market is also becoming increasingly electrified. In 2025, sales of used electric cars exceeded 1.5 million, around 8% of all used car sales, reflecting strong new car uptake in recent years and large numbers of electric cars cycling out of initial ownership for the first time. Turnover was also supported by the [scrappage and trade-in scheme](#) (see [Chapter 1](#)), in which a subsidy of up to CNY 15 000 (Yuan renminbi) (USD 2 000) is provided if a new electric car is bought to replace an older car, CNY 2 000 (USD 275) more than the subsidy received when buying a new conventional car.

In 2024, the levels of electric car resale value retention were lower than the overall levels in China – about [46%](#) for 3-year-old electric cars, compared to around 55% across the broader used car market. By late 2025, average BEV and PHEV resale

values had fallen to [42%](#), a similar percentage point decrease as in the overall used car market, where levels declined to just above 50%. There are several reasons for the difference in depreciation rates between electric and ICE cars in China. Rapid advances in battery technology have quickly made newer electric models far more attractive, accelerating the depreciation of older electric cars. While electric cars generally require less routine maintenance than conventional cars, concerns about battery health and the potential cost of major repairs make the purchase of an older electric car less appealing. So much so that it is estimated that around [80%](#) of used car dealers in China now refuse to accept BEVs that are more than 5 years old.

**Figure 2.9 Average value retention of electric cars compared to overall car market for major regions, 2021-2025**

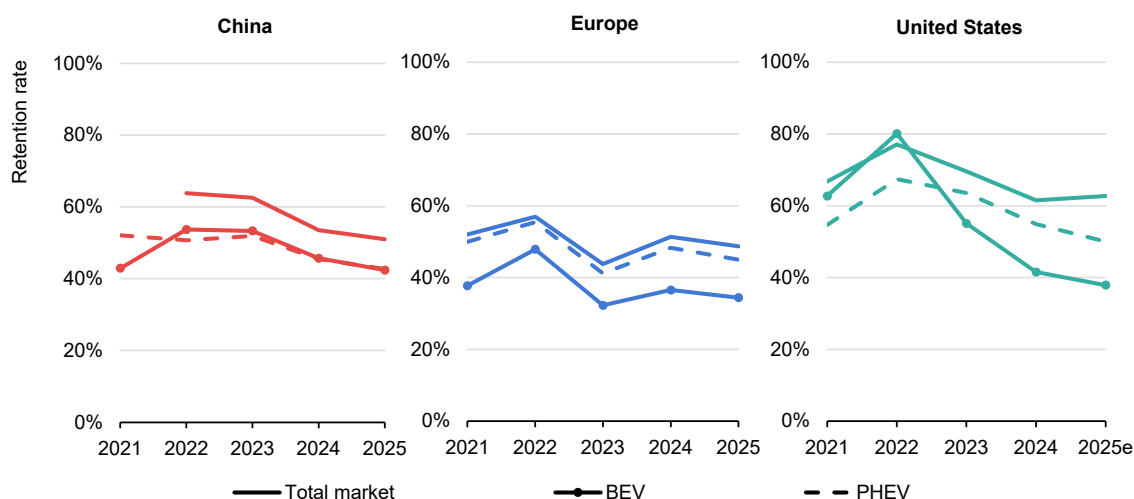

IEA. CC BY 4.0.

Notes: BEV = battery electric vehicle; PHEV = plug-in hybrid electric vehicle. The retention rate is a metric used in second-hand technology markets that represents the value of the vehicle when being resold in relation to the value when originally purchased. A retention rate of 70% means that a product purchased new will lose 30% of its original value, on average, and sell at such a discount relative to the original price. Monthly sales volumes are not available for all markets, making the calculation of a sales-weighted average annual retention rate impossible; instead, the retention rate shown is for the last month of each year. For the United States, 2025 values are estimated due to a lack of data availability. The retention rates shown in the figure could not be corrected for average age of the sales.

Sources: IEA analysis based on [Autovista](#), [Blackbook](#), [Cox Automotive](#) and [IseeCars](#) (for 2025 estimate) and [CADA](#).

## In Europe, resale values for battery electric cars have decreased since 2022 as supply and demand balanced out

In Europe, only around [four in ten](#) of all new car registrations are made by private buyers, while the majority are purchased by company fleets, dealerships or short-term rental firms. As the share of private buyers has steadily [declined](#) over the past decade, the choices made by corporate fleets have become increasingly influential, shaping the pace and direction of Europe's fleet build-up. Across the five European markets analysed – France, Germany, Italy, Spain and the United Kingdom – electric cars represented roughly 4% of used car transactions in 2025, increasing from only 1% in 2021.

Market conditions differ across countries. The United Kingdom remains the largest overall second-hand market among the five, with sales of nearly 8 million used cars in 2025. Meanwhile, Germany recorded the highest sales of used electric cars by volume – around 400 000 – in 2025, corresponding to a little over 6% of the country's used car market.

In 2022, tight supply of used cars lifted resale values across all powertrains in the five European countries analysed. As supply and demand have since rebalanced, overall value retention has declined. However, the value retention of BEVs has weakened more noticeably. Across the five markets, battery electric car retention rates fell from a peak of about 50% in 2022 to 35% in 2025, compared with the overall market's drop from around 60% to 50%. PHEVs show a similar pattern: While PHEVs were broadly aligned with average resale values in 2022, their performance began to diverge from 2023 onwards. The steepest decline was observed in Germany, where PHEV retention rates matched that of the overall market in 2022 but fell to an average of 45% by the end of 2025, around four percentage points below the market average.

### US second-hand electric car market remains volatile

The United States remains the smallest used electric car market among the regions analysed, with less than 400 000 electric car transactions in 2025, representing roughly 2.5% of all used car sales. Despite the market's limited size, activity accelerated last year, as 2025 marked the final year of eligibility for [federal tax rebates](#) on second-hand EVs (see below), contributing to a 30% increase in used EV sales compared with 2024. Tesla continued to dominate the segment, securing three of the top five positions in the ranking of used EV models sold in the United States. About [40%](#) of used EVs sold for under USD 25 000, significantly less than a new electric car in the United States (see above), with a used Nissan LEAF remaining one of the most accessible models, priced at about USD 12 000.

Resale values in the United States have been highly volatile compared with other major markets. In 2022, BEV resale values outperformed the overall used car market, reflecting the limited availability of electric models at the time. This trend reversed sharply in 2023 following Tesla's price cuts for new cars, which rapidly eroded used EV pricing. By mid-2025, BEV resale values had fallen further amid a rush to capitalise on the expiring tax incentives for second-hand cars, which provided a tax rebate of USD 4 000 for used vehicles priced below USD 25 000. In contrast, overall used car prices increased, driven in part by tariff-related cost pressures. As a result, BEV resale values ended 2025 roughly 25 percentage points below the overall market.

## Policies that consider the resale value can help to improve electric car affordability

Policies and business models that strengthen the value retention of electric cars can play a direct role in improving the value proposition of new electric cars and accelerate mass-market adoption of EVs. Strong value retention reduces ownership risk for private buyers and gives fleet operators more confidence to purchase new electric cars, since predictable residual values make leasing and financing more cost effective.

Some companies are already experimenting with measures to stabilise or guarantee used EV values. For example, [VinFast](#) has introduced a Residual Value Guarantee in the Philippines, promising to buy back its electric models for up to 90% of the original price after six months and 70% by the third year of use. Similarly, [Hyundai](#) began guaranteeing a residual value of up to 55% back in 2024 for electric cars, and [announced](#) a similar programme for fuel cell electric cars in 2025.

In addition, there are several examples of governments subsidising used electric car sales. In 2025, five [European](#) countries had some form of incentives available for used electric cars: Belgium, Iceland, Lithuania, Luxembourg and Sweden. Until the end of 2024, the Netherlands offered EUR 2 000 (USD 2 150) as part of the [SEPP](#) scheme, and the United States offered a federal tax rebate of up to USD 4 000 in the first half of 2025. In [France](#), until the end of 2024, car buyers that scrapped their old diesel car could receive up to EUR 5 000 (USD 5 380) if they replaced their car with an electric or hybrid car, whether the replacement was new or second-hand.

## Government support for electric car sales

### Government support per vehicle has declined although public finance increased in absolute terms as sales rose

Government support per electric car, in the form of direct purchase subsidies, tax incentives and import duty reliefs, has steadily declined over the past decade as sales have increased. This decrease in public funding started to accelerate in 2023, as governments in major markets phased out purchase incentives or tightened subsidy eligibility requirements. In 2025, government support accounted for just under 7% of total spending on electric cars globally, compared to over 12%

in 2019.<sup>11</sup> Despite lower per-vehicle support, growth in electric car sales globally resulted in public finance increasing in absolute terms in 2025, to reach about USD 60 billion – a roughly 20% rise from the previous year. As sales have risen, total spending on electric cars globally has grown continuously, to reach about USD 860 billion in 2025.

**Figure 2.10 Government support for electric cars by support mechanism and by powertrain, 2019-2025**

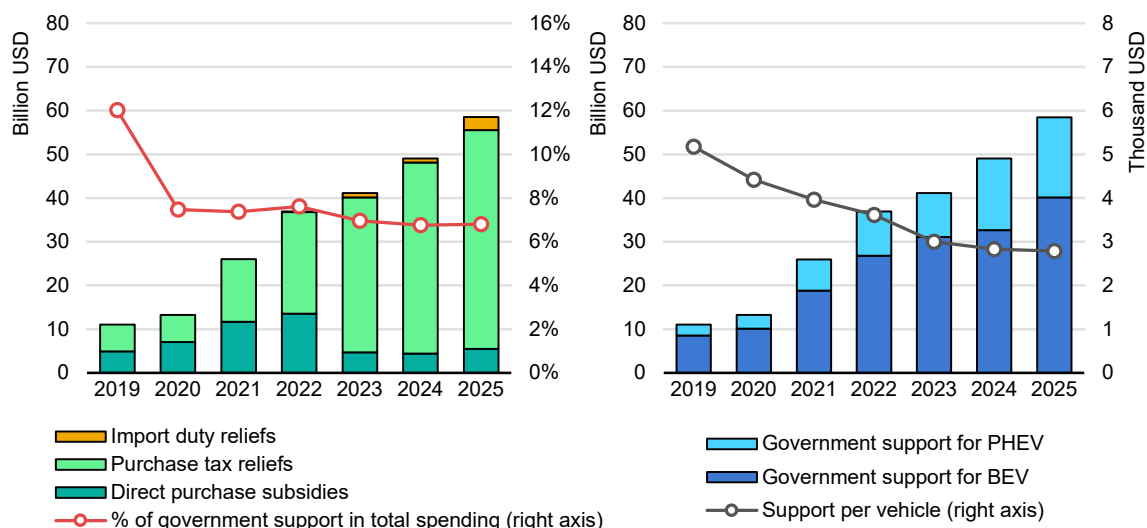

IEA. CC BY 4.0.

Notes: BEV = battery electric vehicle; PHEV = plug-in hybrid electric vehicle. Monetary values are adjusted for inflation. Government support is the sum of direct central government spending through purchase subsidies and foregone revenue due to purchase, excise, registration taxes and import duties waived specifically for new electric cars, using the case of conventional cars as a counterfactual. Only central government (national) purchase support policies for electric cars are taken into account. Spending on charging is not included. Values and trends may have changed slightly relative to previous publications following methodology improvements and better coverage of government support schemes. Sources: IEA analysis based on [EV Volumes](#), [S&P Global Mobility](#) and national policy documents.

## Electric car purchase incentives shift across major markets as subsidy schemes evolve

### Tax exemptions dominate government support in China but will tighten from 2026

Government spending in **China** accounted for nearly 60% of the global total in 2025. Scrappage and trade-in schemes were largely continued in 2025, with [18.3 million applications](#) filed in 2024 and 2025, accounting for nearly 40% of car

<sup>11</sup> Total spending is calculated as the sum of the total market value of electric car sales and foregone tax and import duty revenues. Government support is the sum of subsidies and foregone tax and import duty revenues. Market value is calculated as electric car sales multiplied by their average list model price, before incentives.

sales over the same period. The 10% purchase tax exemption for electric cars remains the primary source of government financial support for buyers. In 2025, the purchase tax exemption represented more than 90% of Chinese government support, in the form of foregone revenue.

However, starting from January 2026, policy updates reducing access to new energy vehicle (NEV) purchase incentives are expected to significantly reduce government spending. Firstly, the preferential purchase tax policy for NEVs entered a new [phase](#) in 2026, in which the full exemption has been replaced with a 50% tax reduction, linked to vehicle energy consumption for BEVs and electric range for PHEVs, reducing both the scope of eligibility and levels of support. Similarly, [trade-in and scrappage schemes](#) are moving away from a fixed subsidy amount to price-capped and energy-efficiency-linked incentives, further reducing per-vehicle government spending in 2026.

**Figure 2.11 Government support for electric cars by region and support mechanism in selected countries and regions, 2019-2025**

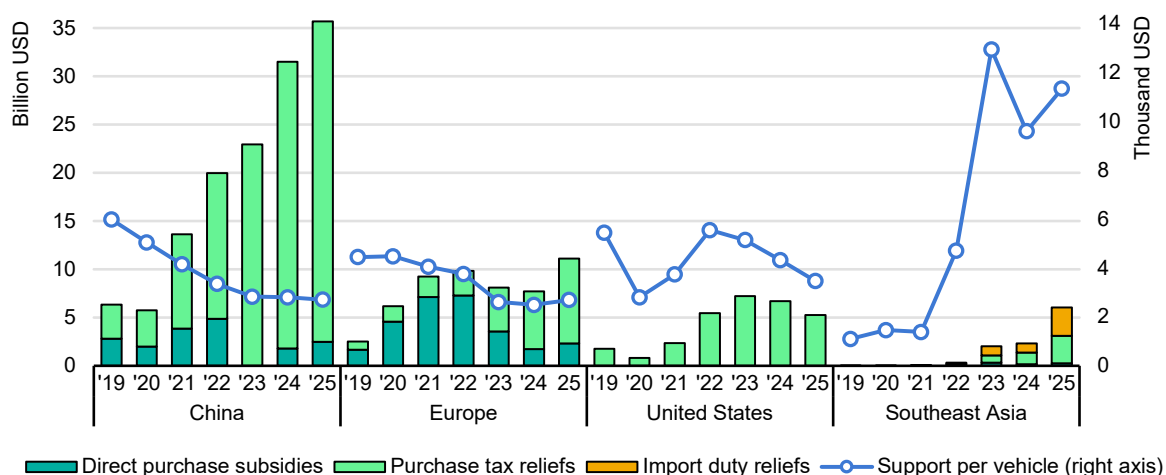

IEA. CC BY 4.0.

Notes: Monetary values are adjusted for inflation. Government support is the sum of direct central government spending through purchase incentives and foregone revenue due to purchase, excise, registration taxes and import duties waived specifically for new electric cars. Only central government (national) purchase support policies for electric cars are taken into account. Spending on charging is not included. Excludes incentives for company cars and vehicle ownership taxes. Values and trends may have changed slightly relative to previous publications following methodology improvements and better coverage of government support schemes.

Sources: IEA analysis based on [EV Volumes](#), [S&P Global Mobility](#) and national policy documents.

## Electric car sales growth and tax exemptions offset declining subsidies in Europe

Despite several countries in **Europe** having reduced or phased out purchase subsidies in recent years, especially for middle- to high-income households, increasing electric car sales pushed government support to a record high of over USD 11 billion in 2025, up more than 40% from the previous year. [Belgium](#), the [Netherlands](#) and [Austria](#) all ended their purchase subsidy schemes in

December 2024. This followed the end of subsidy programmes in the [United Kingdom](#), [Sweden](#) and [Finland](#) in 2022, the phase-out of subsidies in [Germany](#) in 2023, and a scale-back of subsidies in [France](#) in 2023.

However, measures in some other European countries also contributed to higher regional spending in 2025. The [United Kingdom](#) reinstated purchase subsidies in 2025 with the GBP 650 million (about USD 830 million) “Electric Car Grant”, supporting the sales of a few [eligible](#) electric models priced below GBP 37 000 (about USD 47 000). [Italy](#) doubled per-vehicle support through the revised “Eco bonus,” which targets lower-income households scrapping older vehicles. In [Spain](#), strong growth in electric car sales increased the fiscal cost of the extended “MOVES III” subsidy programme. The launch of the “NaszEauto” EV subsidy scheme in [Poland](#) also contributed to government spending in Europe in 2025, albeit to a negligible extent, as its electric car market remains relatively small.

**Figure 2.12 Government support and electric car sales by European country, 2019-2025**

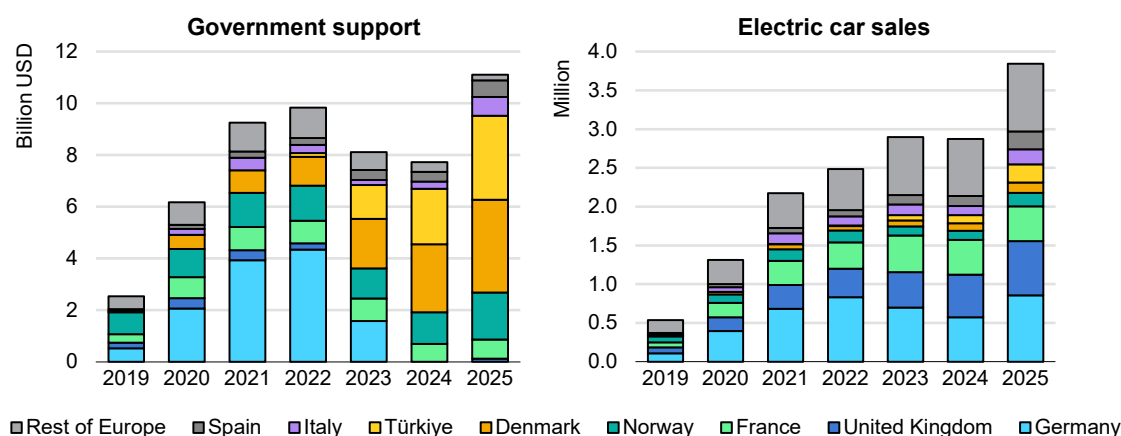

IEA. CC BY 4.0.

Notes: Monetary values are adjusted for inflation. Government spending is the sum of direct central government spending through purchase incentives and foregone revenue due to purchase, excise, registration taxes and import duties waived specifically for new electric cars. Only central government purchase support policies for electric cars are taken into account. Spending on charging is not included. Excludes incentives for company cars and vehicle ownership taxes. In this analysis, the 15 largest European electric car markets are included. “Rest of Europe” includes Belgium, Sweden, Switzerland, Austria, Finland and Poland.

Sources: IEA analysis based on [EV Volumes](#), [S&P Global Mobility](#) and national policy documents.

Since 2022, the reduction in purchase subsidies seen in major European markets has been offset by increasing support (via foregone tax revenues) in countries where electric cars benefit from significant registration tax exemptions, namely Denmark, Türkiye and Norway, which have seen soaring EV sales. In [Türkiye](#), the [ÖTV](#) registration tax has been reduced from 80% of the list price for conventional cars to 10% for BEVs priced below TRY 1.45 million (Turkish liras) (roughly USD 35 000) and less than 160 kW, rising to 60% for other models. In July 2025, the ÖTV tax structure [evolved](#), setting a minimum 25% rate for BEVs priced up to

TRY 1.65 million (roughly USD 40 000), and a maximum 75% rate for pricier and more powerful models. Similarly, in [Denmark](#), BEV buyers pay only 40% of the up to 150% progressive vehicle registration tax for conventional cars. [Norway](#) maintains sizeable tax incentives, with a VAT exemption on the first NOK 500 000 (roughly USD 46 500) of the BEV price (although this will be reduced in 2026) and exemptions from most components of the vehicle registration tax, which for conventional and hybrid cars is based on CO<sub>2</sub> emissions, nitrogen oxides (NO<sub>x</sub>) emissions and vehicle weight. As a result, the distribution of government support for electric car sales across Europe shifted significantly in 2025. Despite representing less than 15% of electric car sales in Europe's 15 largest markets, Denmark, Türkiye and Norway together accounted for over 75% of government support in 2025, up from above 25% in 2022.

In 2026, government support across Europe is likely to increase further as some countries reinstate their purchase subsidy programmes. [Germany](#) has reintroduced subsidies supported by a [EUR 3 billion](#) (USD 3.2 billion) budget envelope, with subsidies linked to household income and vehicle price. [Sweden](#) and [Italy](#) also renewed their EV purchase subsidy programmes in 2026.

### US EV purchase support ends after the phase-out of tax credits

In the **United States**, the One Big Beautiful Bill Act (OBBBA) ended the Clean Vehicle Tax Credit after September 2025. Given that some consumers rushed to purchase electric cars before the tax break ended, the effect on full-year spending by the federal government was rather muted. In 2025, US government spending totalled less than USD 3 500 per electric car, nearly 40% lower than the USD 5 500 peak observed in 2022. This decreasing trend was driven by the tax credit eligibility shifting from a broad deployment incentive to a more targeted industrial policy tool between 2022 and 2025. In 2022, [eligibility](#) was mainly restricted based on battery size and manufacturer caps. From 2023, the Inflation Reduction Act (IRA) removed the manufacturer caps, introduced a North American assembly requirement, and split the USD 7 500 credit into two parts tied to battery components and critical minerals, resulting in partial eligibility for some models. In 2024 and 2025, tighter sourcing thresholds and “foreign entity of concern” rules further restricted eligibility, narrowing the pool of qualifying models. In the absence of the tax credit, there is expected to be virtually no government financial support for the purchase of electric cars in 2026.

### Import duty exemptions underpin EV support in Southeast Asia

In **Southeast Asia**, most government support for electric car sales took the form of import duty exemptions and registration tax relief. Thailand is the only country offering purchase subsidies, through its [EV3.5 scheme](#). The country also granted import duty exemptions (which ended in December 2025) and excise tax

exemptions for electric cars from carmakers committing to begin producing in Thailand by 2026. Since 2022, [Thailand](#), [Indonesia](#), [Malaysia](#) and the [Philippines](#) have primarily relied on trade-related policy tools to support electric car uptake, while [Viet Nam](#) and [Singapore](#) have focused on registration tax reliefs. Thailand, Indonesia and Malaysia all have large domestic car manufacturing bases, and levy high import duties on cars to encourage domestic production.

In 2025, foregone revenues linked to import duty reliefs in Southeast Asia represented nearly half of the roughly USD 6 billion in government support for electric car sales. Overall, the absolute amount of government support more than doubled year-on-year as a result of soaring sales. Per-vehicle support is expected to decline in 2026 as most tariff exemptions are set to expire or to see their eligibility criteria tighten as incentives are increasingly linked to domestic production. The Philippines is a notable exception, as its import duty exemptions are expected to remain in place through 2028 based on current policies.

# Chapter 3. Trends in other light-duty electric vehicles

## Electric two- and three-wheelers

### The sales share of electric two- and three-wheelers remained around 15% globally

Two- and three-wheelers (2/3Ws)<sup>12</sup> remained the most electrified road transport segment in 2025, with about 10% of the global fleet now electric. Sales of electric 2/3Ws increased almost 15% to reach 11 million globally in 2025, representing around 15% of total 2/3W sales. The modest rise in sales share (1 percentage point higher than in 2024) reflects diverging trends in major markets: Despite sales in People's Republic of China (hereafter, "China") recovering only to levels similar to those observed in 2023, and sales in India increasing less than in 2024, robust momentum in Viet Nam and Türkiye underpinned global growth. China, Türkiye, India and Viet Nam together accounted for 95% of electric 2/3W sales worldwide. The number of electric 2Ws sold is almost eight times as big as that of electric 3Ws, but the sales share of electric 3Ws reached more than 25%, almost double that of electric 2Ws.

### Increasing sales of electric two-wheelers in Viet Nam drove global growth

Sales of electric 2Ws increased to almost 10 million in 2025, growing 15% year-on-year and reaching a share of around 14% of 2W sales globally.

The world's largest market for electric 2Ws today is **China**, where sales reached more than 7 million in 2025, with a sales share of over 55%. There was a 10% increase in sales in 2025, contrasting with the previous decline underway since 2021 following a shift in electric 2W adoption patterns. Strong growth in low-speed electric bicycle sales, supported by [trade-in schemes](#), together with a [transition](#) by domestic 2W manufacturers away from high-volume production towards powerful internal combustion engine (ICE) models for recreational use, have slowed momentum in electric 2W sales.

---

<sup>12</sup> In this report, "two-wheelers" refers to vehicles with a top speed of at least 25 km/hr that fit the L1 and L3 classes defined by [The United Nations Economic Commission for Europe \(UNECE\)](#). This excludes micromobility options such as electric-assisted bicycles and low-speed electric scooters. The definition of a three-wheeler is aligned with UNECE L2, L4 or L5 classes.

**India** remains the second-largest electric 2W market, despite sluggish sales in 2025. Sales of electric 2Ws grew by 5% to reach less than 1.3 million, representing around 6% of total 2W sales in the country. Several factors may have contributed to the slowdown in growth compared to previous years. Policy support in the form of the PM Electric Drive Revolution in Innovative Vehicle Enhancement ([PM E-DRIVE](#)), introduced in late 2024 and [extended](#) to 2028 to replace previously existing financial support schemes, did not provide sufficient impetus for the growth of past years to continue in 2025. Under the previous [FAME-II scheme](#), electric 2Ws could receive USD 170/kWh and up to 40% of the vehicle cost. In contrast, under the [PM E-DRIVE](#) scheme this was reduced to USD 57/kWh, capped at USD 115 per vehicle for fiscal year 2024-2025 and to less than USD 30/kWh capped at USD 57 per vehicle for fiscal year 2025-2026. Moreover, the new scheme introduced [local content requirements](#) that are costly for [some OEMs to meet](#), which in turn has reduced the number of models eligible for subsidies compared with previous schemes. In addition, the September 2025 reform of the [Goods and Services Tax \(GST\)](#) reduced the tax rate for low-displacement ICE 2W models, while leaving the rate for electric models unchanged, weakening their purchase price competitiveness.

**Figure 3.1 Electric two-wheeler sales and sales share by region, 2020-2025**

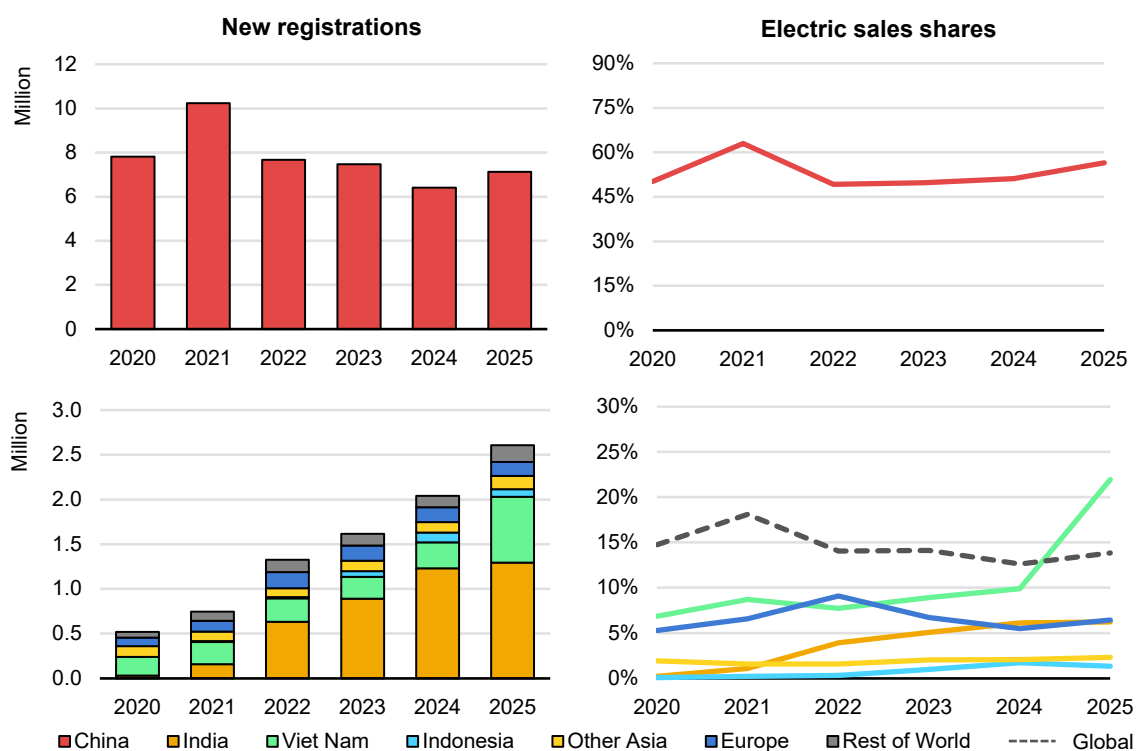

IEA. CC BY 4.0.

Notes: “Other Asia” includes Afghanistan, Bangladesh, Brunei, Cambodia, Lao People’s Democratic Republic, Myanmar, Mongolia, Nepal, Pakistan, Singapore, Sri Lanka and Chinese Taipei. “Two-wheeler” refers to vehicles with a top speed of at least 25 km/hr and which fit the L1 and L3 classes defined by [UNECE](#).

Sources: IEA analysis based on country submissions and data from MotorcyclesData.com.

The market for electric 2Ws in **Southeast Asia** has grown consistently in recent years, with sales increasing from 235 000 in 2020 to almost 900 000 in 2025. **Viet Nam** is the region's largest market for electric 2Ws, with sales more than doubling to around 735 000 vehicles in 2025. As a result, electric 2W sales represented more than 20% of 2W sales in the country, and Viet Nam accounted for over 30% of global sales growth in 2025. Sales in Viet Nam were led by local companies such as VinFast and Pega, followed by Chinese brands such as Dibao and Yadea. Growing competition has spurred industry-led promotional campaigns and incentives, such as [discounts and trade-in schemes](#), in an attempt to win market share. Plans for low-emission zones in Hanoi from July 2026 and Ho Chi Minh City from early 2027 may further encourage consumers to switch to electric 2Ws (see [Chapter 9](#)).

In contrast, electrification of 2Ws is proceeding slowly in **Indonesia**, the biggest 2W market in Southeast Asia, with the sales share reaching only 1.3% in 2025. Sales of electric 2Ws fell by 20% in 2025 to 86 000. Previously, in 2024, subsidies had helped push sales to a record high of over 110 000, of which around [90% were supported by subsidies](#), but after the programme ended in late 2024 momentum tailed off and sales decreased.

Sales of electric 2Ws have grown markedly in **Africa**, from less than 1 000 in 2020 to around 70 000 in 2025. The use of 2Ws for ride-hailing, delivery and other commercial applications – where purchase decisions are especially cost-sensitive – has helped drive up the sales of electric 2Ws, especially in countries such as Uganda and Kenya. Battery-swapping is also being deployed to support the uptake of electric 2Ws used for commercial services in some markets in Africa, and notably also in Asia (see [Chapter 6](#) for more details).

**Uganda** has become one of Africa's fastest-growing markets for electric 2Ws, with sales exceeding 30 000 in 2025, having risen sharply from a low base in 2024. Key to growth was the rapid scale-up of financing programmes for 2W purchases, led by Kenya-headquartered [Spiro](#), which reported a large rollout in 2025, supported by an expanding battery-swapping network. Zembo Motorcycles, a company focused on electric 2Ws, which provides battery swaps, secured USD 1 million in funding from the Dutch entrepreneurial development bank [FMO](#) in order to acquire batteries and chargers. Policy measures have complemented private-sector scaling. Uganda's national [e-mobility agenda](#) includes fiscal incentives intended to attract investment in domestic assembly and manufacturing, including income tax holidays and VAT exemptions for eligible domestically manufactured electric vehicles (EVs) and charging-related equipment.

In **Kenya**, high gasoline prices relative to electricity prices, combined with the large share of the population with reliable access to electricity, make a strong economic case for electric 2Ws. As a result, year-on-year electric 2W sales more than tripled in 2025, reaching over 25 000 and representing around 15% of new 2W registrations. This rapid growth occurred even despite relatively limited policy

support, although in 2025 the government confirmed that domestically assembled electric models would [continue](#) to be VAT exempt. Uptake by commercial 2W taxi services was a key driver of adoption: riders typically earn about [USD 10-15 per day](#), and for conventional 2Ws can spend 40%-60% of their earnings on fuel, as well as being exposed to fluctuations in oil prices. By contrast, energy costs for electric 2Ws are typically less than USD 2 per day. These cost advantages have underpinned rising demand, prompting domestic manufacturers such as [Spiro](#) and [Roam](#) to scale up production. Financing and business model innovation have further supported uptake. Companies offering [ride-to-own](#) programmes and daily [micro-payments](#) aligned with users' cash flows have helped make electric options more accessible. Electric 2Ws now make up [40% of Bolt's motorcycle fleet](#), supported by financing schemes of this kind.

**Europe** accounted for less than 2% of global electric 2W sales in 2025, or around 160 000 sales, a decline of almost 5% from 2024. While the region's sales share rose steadily between 2015 and 2020, it has since levelled off at around 6%. This reflects structural factors, such as lower adoption of 2Ws compared to other markets, as well as a stronger preference for micromobility among consumers and limited policy support. Türkiye remains the largest market in Europe, with sales in 2025 growing by 1.5% to just over 58 000. France follows, with 22 000 electric 2W sales, a decline of 25% from 2024.

## India remains the world's largest electric three-wheeler market, with over two-thirds of 2025 sales being electric

Sales of 3Ws declined globally in 2025, to around 4.5 million, down 16% from 2024. Meanwhile, electric 3W sales increased to more than 1.2 million, resulting in a sales share of more than 25% in 2025. The electric 3W market is highly concentrated, with China, India and (to a lesser extent) Türkiye accounting for more than 95% of all sales worldwide.

**Figure 3.2 Electric three-wheeler sales and sales share by region, 2020-2025**

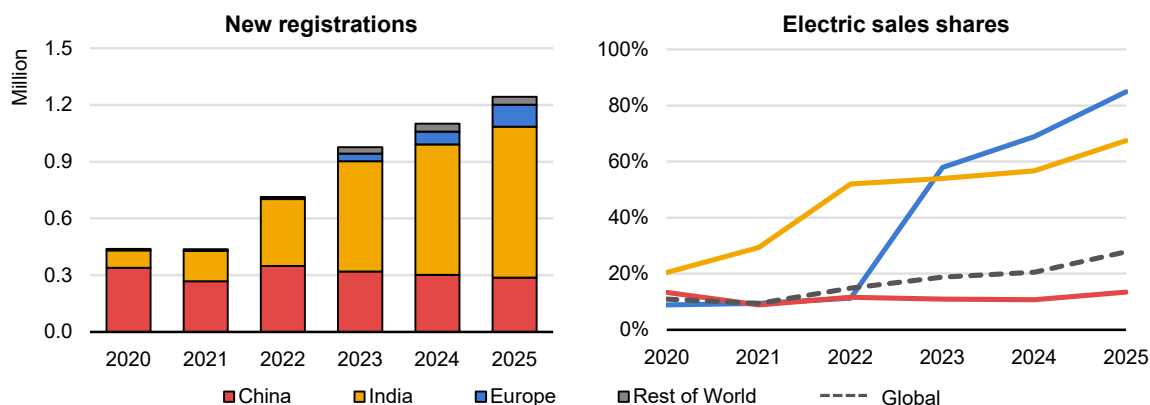

IEA. CC BY 4.0.

Note: The definition of a three-wheeler is aligned with [UNECE](#) L2, L4 or L5 classes.

Sources: IEA analysis based on country submissions and data from [MotorcyclesData.com](#).

In **India**, momentum in electric 3W sales continued to build, with sales rising by 15% from 2024 to almost 800 000 vehicles. Electric 3Ws now capture almost 70% of all sales in the country, primarily displacing [compressed natural gas](#) models. Despite subsidies for 3Ws having been reduced under the [PM E-DRIVE](#) policy compared with the FAME II scheme, adoption has not slowed. Support for electric 3Ws under the scheme was initially expected to run until March 2026, but has been [extended](#)<sup>13</sup> to 2028. Funds for models in the L5 category had been fully exhausted by December 2025, but allocations for e-rickshaws and e-carts remain available. As a result, electric 3Ws became the first mode of transport to reach the government's deployment target of around 290 000, despite representing only 10% of the overall target number of vehicles.

Sales of electric 3Ws in **China** declined by 5% in 2025 to less than 290 000, continuing a trend that began in 2022, although the electric sales share increased to around 13%.

In **Europe**, the electric 3W sales share reached more than 80%, continuing a rapid increase started in 2023. Türkiye accounts for around 95% of the 115 000 electric 3Ws sold in the region and is the key engine of growth. Just 5 years ago, sales of 3Ws (ICE and electric) in Türkiye stood at around 6 000, but by 2025, sales of electric 3Ws had grown to more than 100 000. By contrast, sales of conventional 3Ws decreased by more than 40% over the same period.

## Electric light commercial vehicles

### Sales of electric LCVs grew almost 70% in Europe in 2025, driving global growth

Sales of electric light commercial vehicles (LCVs) topped 430 000 worldwide in 2025 – a year-on-year growth of 45%. The global market for electric LCVs is highly concentrated, with Europe and China accounting for around 80% of all sales.

**Europe** is the largest market for electric LCVs, and sales reached almost 200 000 in 2025, representing a 70% increase from 2024 and a 50% increase from the previous all-time high in 2023. This was in spite of a small decline in total LCV sales, which resulted in the electric sales share increasing from 5% in 2024 to 10% in 2025.

Battery electric LCVs accounted for around 80% of the growth in electric LCV sales in 2025, but plug-in hybrid electric LCVs also gained traction, with their sales

---

<sup>13</sup>The extension only applies to e-rickshaws and e-carts.

nearly quadrupling in 2025. The share of electric LCV sales in Europe that were plug-in hybrids jumped from 5% in 2024 to more than 10% in 2025, although they continue to represent only a very small share (about 1%) of total vehicle sales in the region.

Multiple factors lie behind the growth in the European market, including more stringent CO<sub>2</sub> emissions targets, additional low-emission zones and the maintenance of financial support. Importantly, the [EU CO<sub>2</sub> standards](#) require the average CO<sub>2</sub> emissions of new vans sold to be 15% lower over the 2025-2027 period compared to 2021, creating pressure on OEMs to increase sales.

The introduction of new models is also enlarging the customer base for electric LCVs. The five new models introduced by [Ford](#) and [Volkswagen](#) in Europe from the second half of 2024 through to the end of 2025 accounted for around 15% of all sales. New players are also entering the market, such as [Flexis](#), which was founded in 2024 by Renault, Volvo Group and CMA-CGM and has since been fully [acquired](#) by Renault. Flexis announced its vehicle line-up in 2025 and plans to begin production in mid-2026.

The United Kingdom, France, Germany and the Netherlands remain the largest electric LCV markets in Europe. In the **United Kingdom**, which has the largest market for electric LCVs in Europe, registrations increased 50% in 2025, with plug-in hybrid electric LCV sales quadrupling to account for half of the increase in sales. In early 2026, the UK government launched a USD 1.3 billion [grant](#) for British businesses to roll out clean trucks and vans. In addition, the “[benefit-in-kind](#)” charge for the private use of a zero-emissions company van is set at GBP 0. This means that if an employer allows an employee to use an electric van for private purposes, no taxable “benefit-in-kind” is applied, making electric vans fiscally more attractive to users than equivalent ICE vans. In **Germany**, after a decline in electric LCV sales in 2024, sales more than doubled year-on-year in 2025, marking the strongest growth among major European markets. There was no significant change in national policy support, but from 2025 onward, only vehicles with valid [green emissions stickers](#) – available only to LCVs meeting at least the Euro 4 diesel standard<sup>14</sup> – are permitted to enter low-emission zones. **France** recorded growth of more than 25% in battery electric LCV sales, and sales of plug-in hybrid electric LCVs increased sevenfold in 2025, as 30 new [low-emission zones](#) were added to the 10 existing zones. **The Netherlands** also saw a remarkable increase in the electric LCV sales share over the same period, rising from less than 10% in

---

<sup>14</sup> The Euro 4 standard was introduced in 2005 and applied to all new cars sold from January 2006.

2024 to more than 80% in 2025, driven by the [introduction](#) of low-emission zones and the [removal](#) of a vehicle tax exemption for ICE LCVs in 2025.

**Figure 3.3 Electric light commercial vehicle sales and sales shares, 2020-2025**

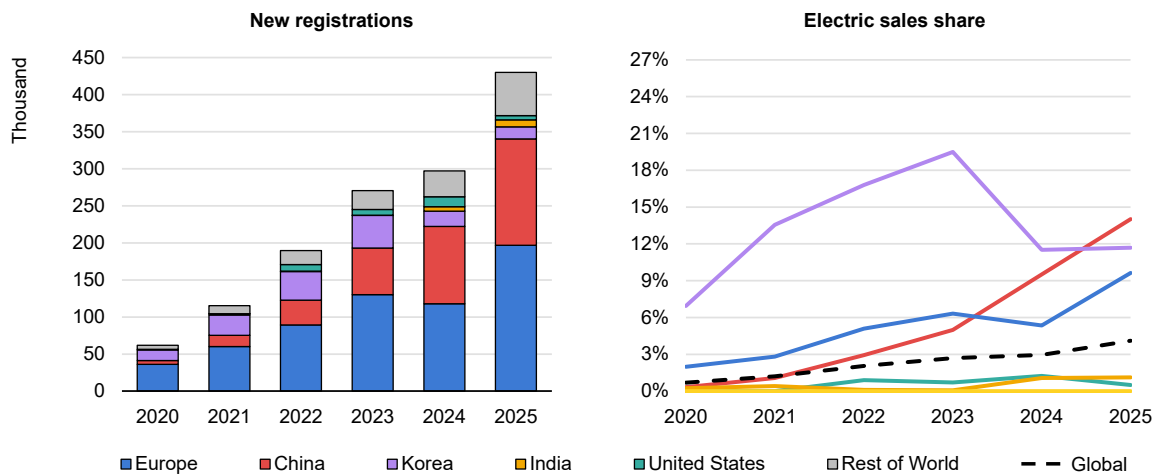

IEA. CC BY 4.0.

Notes: Historical values may differ from what was reported in the [Global EV Outlook 2025](#) as access to more granular data allowed for the reclassification of vehicles with a gross vehicle weight of 3.5 tonnes and above as medium freight trucks, to match IEA definitions. The IEA defines light commercial vehicles as those weighing up to 3.5 tonnes.

Sources: IEA analysis based on data from [EV Volumes](#), [China Automotive Technology and Research Center](#), [ACEA](#), [Marklines](#) and [Korean Automobile Manufacturers Association](#).

**China** is the second-largest market for electric LCVs, with around 140 000 vehicles sold in 2025, up 40% from 2024. As a result, electric LCVs reached a sales share of 14% in 2025. Sales have been rising since 2020 thanks to continued policy support. Electric LCVs have been eligible for the vehicle purchase tax exemption for new energy vehicles since [2014](#), and this was [available](#) through 2025. In addition, a 50% tax exemption has been made available for electric LCVs until the end of 2027. However, LCVs are one of the least electrified vehicle types in China. China's comparatively low rate of electrification for this market segment could be linked to the higher share of freight travelling on trucks, which represent 60% of sales of commercial vehicles, compared to around 20% in Europe. Electrification of medium- and heavy-duty trucks can offer higher operational cost savings than LCVs, as they drive longer distances.

In **Korea**, sales of electric LCVs reached around 16 000 vehicles in 2025, a 60% drop from the 2023 peak. Since 2020, the sales share of electric LCVs in Korea has been higher than for electric cars. In 2025 the gap narrowed, with electric LCVs representing 12% of total LCV sales, compared to a sales share of 11% for electric cars. Only 4 electric LCV models were available in 2025 (compared to around 90 for cars), which might not be enough to satisfy all niches. Hyundai introduced the [ST1 Cargo Electric](#) in June 2024, and Kia followed it with the [PV5](#), built on Hyundai's dedicated [E-GMP.S](#) electric platform. Although the PV5 has a

similar battery size to the ST1, the price tag is about 20% lower and it has a longer driving range. Deliveries of the PV5 started in August 2025, meaning that the impact on 2025 sales was limited, but it may help to drive up electric LCV sales in the coming year.

Electric LCVs sales in **India** totalled more than 9 000 vehicles in 2025, an increase of over 50% compared to the previous year, although the electric share of total LCV sales remains relatively low, at 1%. Models designed for last-mile delivery, such as the Tata Motors Ace EV and the Mahindra Zeo Electric, which together captured 80% of electric LCV sales, have limited battery sizes to keep prices competitive, a strategy made possible by the relatively short daily driving ranges required in these applications.

In the **United States**, the termination of the commercial clean vehicles tax credit after September 2025 meant that sales of electric LCVs dropped by almost 80% compared to the same period in 2024. Sales in 2025 reached almost 6 000, less than half the sales recorded in 2024.

# Chapter 4. Trends in heavy-duty electric vehicles

## Trends in electric bus sales

### Electric bus sales increased by 12% globally in 2025

Sales of electric buses reached almost 70 000 globally in 2025, growing 12% year-on-year. This trend was also supported by the expansion of depot charging infrastructure, which is a crucial enabler of the operation and scalability of electric buses. Battery electric powertrains continue to dominate new electric bus sales, representing 98% of electric buses sold worldwide last year. This has been largely driven by cities, through national and local procurement mandates, as well as public subsidies at both federal and provincial level, which support bus electrification as a way to reduce local emissions. In the European Union, sales continued to increase, supported by the [Clean Vehicles Directive](#) targets for zero-emissions buses for 2025. In the People’s Republic of China (hereafter, “China”), the government has focused on city bus electrification for [more than a decade](#) to help develop the domestic electric vehicle (EV) industry and reduce pollution in cities. Declining battery costs and growth in the number of battery electric bus models available have also supported the transition, as the range of many battery electric bus models is already sufficient to cover the predictable routes of city buses.

**Figure 4.1 Electric bus sales and sales shares by region, 2020-2025**

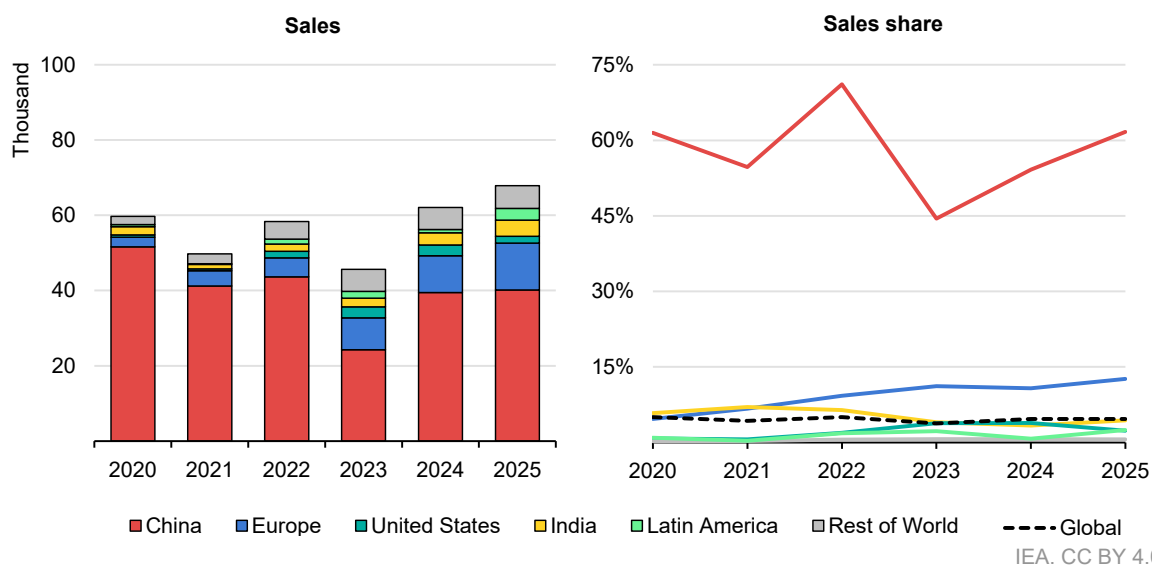

Notes: Refers to buses with ten or more seats, including both urban and intercity buses. Historical sales in China have been updated compared to previous editions of the Global EV Outlook, based on CATARC data, to better reflect IEA vehicle definitions.  
Sources: IEA analysis based on country submissions and data from [EV Volumes](#), [CATARC](#) and India’s [Vahan](#) dashboard.

Although China again accounted for most global electric bus sales in 2025, its share of global sales has gradually declined from nearly 100% in 2018 to around 60% in 2025, as uptake has grown more quickly in other regions. Electric buses have been a target of China's industrial development policies, which has resulted in the build-up of strong domestic manufacturing capacity with greater economies of scale than in other countries. Overall, electric buses represented more than 60% of total bus sales in the country, while sales of city buses were [nearly 100%](#) electric. By contrast, the coach segment, used for intercity transport, is more difficult to electrify, and has been slower to switch. Zero-emissions vehicles represented around [10%](#) of coach sales in China in 2025, less than 3 percentage points higher than in 2024. The relatively low uptake of electric intercity coaches continues to bring down the overall electric bus sales share.

**Europe** has been the world's second-largest electric bus market for the past decade, though sales volumes remain well below those in China. In 2025, sales totalled more than 12 000, 28% higher than in 2024. The share of electric buses in new bus sales exceeded 12% in 2025. The share is even higher for city buses: battery electric city buses reached a share of [over 55%](#) in 2025 in the European Union, up from around 45% the previous year. Several European countries recorded particularly high adoption rates in 2025. Electric buses accounted for more than 60% of new bus sales in Norway, around 30% in the United Kingdom, and over 25% in Germany. This has been supported by sustained policy measures. In the United Kingdom, for example, GBP 143 million (USD 180 million) was allocated under the second round of the Zero Emission Bus Regional Areas ([ZEBRA](#)) programme, which together with the [first round](#) has supported the deployment of nearly [2 300](#) new electric buses over the 2021-25 period – about 30% of the current UK electric bus stock. However, in [Ireland](#) and [the Netherlands](#), the rollout has faced operational challenges, including delays in vehicle deliveries and charging infrastructure deployment, occasionally leading to temporary reliance on diesel fleets.

**India** remained the third-largest electric bus market for the second year in a row, as electric bus sales surpassed 4 000 for the first time in 2025. This increase was supported by the government's large-scale procurement programmes, including the [PM E-DRIVE scheme](#), which aims to deploy up to 14 000 electric buses nationwide between 2024 and 2026, and the [PM-eBus SEWA](#), which supports the deployment of more than 38 000 electric buses through a payment security mechanism offered to operators.

**Latin America** stood out in 2025, as electric bus sales more than tripled year-on-year to exceed 3 000, overtaking sales in the United States. Nearly 2 000 electric buses were sold in Chile alone, representing more than 1 in 5 buses sold in the country in 2025. [Santiago](#) is now home to the largest electric bus fleet of any city outside of China, supporting Chile's [long-term electrification targets](#). Brazil recorded around 850 electric bus sales in 2025, albeit only reaching a sales share of just over 2%. Growth has been supported by [Novo Pac programme](#), which earmarked BRL 10.6 billion Brazilian reals (USD 1.8 billion) for the procurement

of electric buses and rail vehicles across 98 cities. The expansion in electric bus sales in the region, led primarily by Chile and Brazil, was responsible for 30% of the growth in global electric bus sales.

Sales across Latin America are expected to continue to grow. Argentina, for example, is also accelerating the electrification of public transport, with a [regulation](#) requiring all newly procured buses to be electric or powered by compressed natural gas (CNG) starting in 2027. The country already has an extensive CNG refuelling network. In [Buenos Aires](#), electric buses are being promoted through procurement plans and infrastructure deployment. In addition, Colombia is emerging as a regional leader in [electric bus assembly](#), through partnerships with international manufacturers such as BYD and Hino.

Meanwhile, electric bus sales in the **United States** fell 40% in 2025 compared to 2024. Although the US Federal Transit Administration [announced](#) USD 2 billion in funding for bus projects, including through the [Low or No Emission Grant Program](#), none of the 165 selected projects included electric bus purchases or charging infrastructure installation, instead favouring natural gas buses and infrastructure.

## Trends in electric truck sales

### Electric truck sales doubled in 2025 to reach 9% of truck sales worldwide

Sales of electric trucks<sup>15</sup> continued to grow for the fifth consecutive year in 2025, exceeding 400 000 for the first time and doubling compared to the previous year. Globally, electric trucks reached 9% of all truck sales in 2025, surpassing the EV sales share for buses and light commercial vehicles.

In particular, the electric heavy freight truck (HFT) segment expanded significantly: sales of electric HFTs almost tripled year-on-year, from around 84 000 in 2024 to a record high of 230 000 in 2025.<sup>16</sup> Sales of electric medium freight trucks (MFTs) grew more slowly, but still increased 65% year-on-year to reach 210 000 in 2025. The share of electric trucks within total HFT sales reached 9%, having accelerated from just over 3% in 2024, while electric MFT sales also reached 9%, increasing from 6% of sales in 2024.

Battery electric trucks accounted for nearly all – 97% – of electric truck sales globally in 2025. This is partly because battery electric truck models far outnumber plug-in hybrid electric truck models, and because battery electric trucks tend to be more cost-competitive.

---

<sup>15</sup> “Trucks” refers to both medium and heavy freight trucks.

<sup>16</sup> Medium freight trucks (MFTs) have a gross weight of 3.5 to 15 tonnes. Heavy freight trucks (HFTs) have a gross weight >15 tonnes.

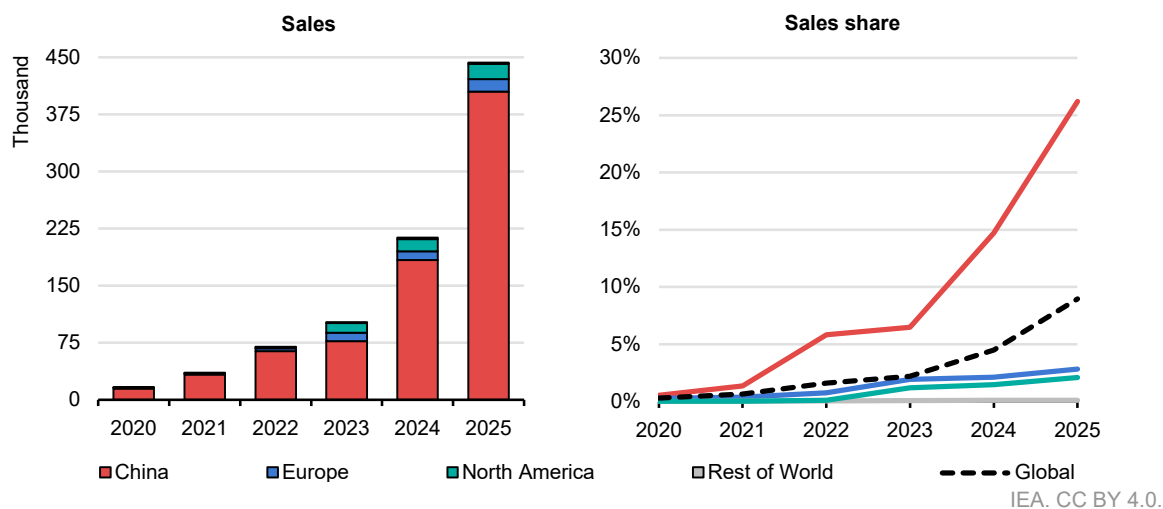
**Figure 4.2 Electric truck sales and sales shares by region, 2020-2025**

Notes: Both medium and heavy freight truck sales are included. Historical values may differ from what was reported in the [Global EV Outlook 2025](#) as access to more granular data allowed the reclassification of delivery vans and other vehicles with a gross vehicle weight of 3.5 tonnes and above from light commercial vehicles to medium freight trucks, to match IEA definitions.

Sources: IEA analysis based on country submissions and data from [EV Volumes](#) and [CATARC](#).

## One in four trucks sold in China in 2025 was electric

The majority of global electric truck sales growth in 2025 came from **China**, where sales more than doubled in 2025, just as in 2024. In 2025, sales of electric trucks surpassed 400 000, meaning China accounted for over 90% of global sales.

One in four trucks sold in China in 2025 was electric, as momentum continued to build thanks to operational cost advantages as well as declining battery costs. As highlighted in the [Global EV Outlook 2025](#), battery electric HFTs in China have already reached total cost of ownership (TCO) parity with diesel trucks in certain cases after 5 years of ownership. Strong policy measures from the government further incentivised growth: the renewed [scrappage scheme](#) offered owners up to around [USD 20 000](#) to replace older trucks (i.e. trucks compliant with China IV emissions standards or earlier pollutant emissions standards) with cleaner trucks – either new energy vehicles or conventional trucks that meet China VI [emissions standards](#). The subsidy is sufficient to cover around 20-50% of the average electric truck price premium in China. Decarbonisation [targets](#) for heavy industry have also strongly supported the switch to electric trucks, especially in the steel and cement sectors. In addition, [Stage 4](#) heavy-duty vehicle (HDV) fuel consumption standards came into effect in July 2025, requiring a 12-16% improvement compared to Stage 3 by including [stricter fuel consumption](#) limits, adjusting the testing procedure and expanding coverage.

Sales of electric HFTs in China reached an impressive 28% of total HFT sales in 2025, up from 13% in 2024. In December 2025, the EV sales share reached [around 50%](#) for the first time, reflecting an end-of-year surge in sales as fleet

purchasers anticipated that the scrappage scheme may come to an end.<sup>17</sup> Electric MFT sales also benefited from the same support schemes and reached a 24% sales share in 2025, up from 16% in 2024. Sales have continued to grow across the first quarter of 2026, with electric truck sales up more than 20% year-on-year.

The impressive growth in electric truck sales has been mainly concentrated in certain applications. [Many](#) of the electric trucks deployed in China are used on short, predictable routes related to activities surrounding ports, mining areas and steel production, or are [utility vehicles](#). Trucks travelling along predictable routes, particularly within industrial hubs, are also well-suited to the growing truck battery-swapping operations in China. Battery swap-capable trucks accounted for around 15% of China’s electric truck sales in 2025.

### Box 4.1 The growth of alternatively fuelled truck sales in China

Over the past few years, China has seen a rapid rise in both battery electric and liquefied natural gas (LNG)-fuelled heavy-duty trucks, driven by relatively low fuel prices, truck [scrappage](#) programmes, tightening emissions [regulations](#) and expanding fuelling and charging infrastructure. Today, the country is home to both the world’s largest electric truck fleet and the largest gas-powered truck fleet, each at over 1 million.

#### Truck sales and sales shares by powertrain in China, 2020-2025

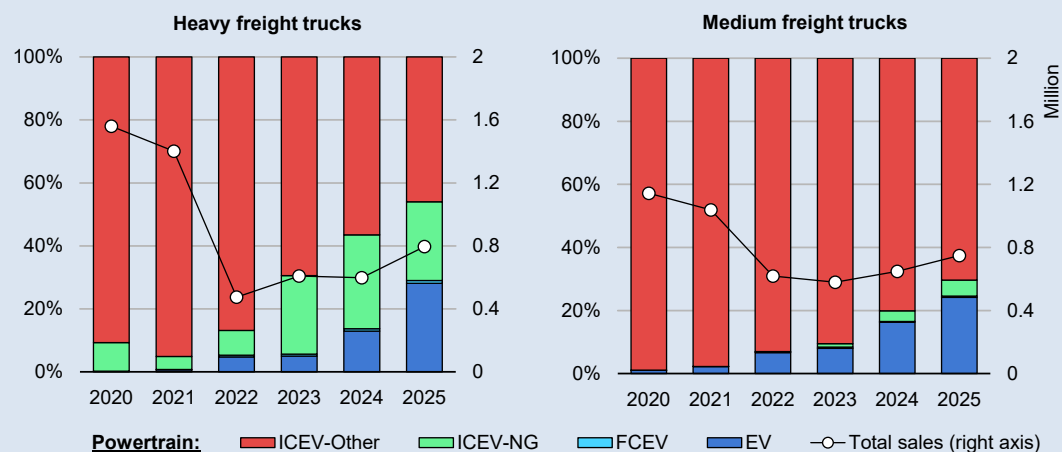

IEA. CC BY 4.0.

Notes: ICEV = internal combustion engine vehicle; NG = natural gas; FCEV = fuel cell electric vehicle; EV = electric vehicle.

Source: IEA analysis based on [CATARC](#).

Fuel costs have been the primary driver of this trend, particularly when comparing diesel and LNG powertrains. Diesel prices in China increased by 35% from 2020

<sup>17</sup> At the end of 2025, it was announced that the scrappage scheme would in fact be continued in 2026.

to 2022, and have levelled off at around 25% higher than 2020 prices in the past few years. As a result, commercial fleet operators have increasingly sought lower-cost alternatives.

LNG trucks typically cost more upfront than diesel trucks, due to the additional cost for the cryogenic storage system, but lower fuel prices can quickly offset this premium. In recent years, LNG prices at refuelling stations have generally ranged around [USD 4-5 per kilogramme](#). Assuming an annual mileage of 100 000 km, operating an LNG truck rather than a diesel truck could save more than USD 13 000 per year for truck operators. These operational costs give LNG trucks an advantage over diesel equivalents on a TCO basis. However, this advantage is highly dependent on the relative price of natural gas to diesel, and LNG truck sales in China have historically been very [sensitive](#) to gas price volatility.

**Total cost of ownership of heavy freight trucks by powertrain in China, 2025**

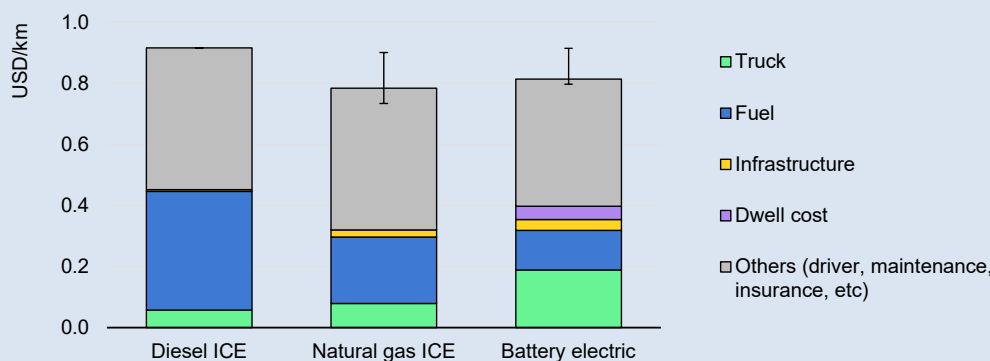

IEA. CC BY 4.0.

Notes: ICE = internal combustion engine. Error bars represent results from a sensitivity analysis varying natural gas price and utilisation of the electric truck charger. Energy carrier prices are based on 2025 values. Sources: IEA analysis based on sources and assumptions listed in [Annex D](#) of this report.

Battery electric trucks come with an even higher upfront price premium than LNG trucks when compared to diesel internal combustion engine (ICE) trucks, but their higher energy efficiency also means that operational costs are even lower. Battery electric HFTs show a similar TCO to LNG versions, both offering a more than 10% TCO reduction compared to a diesel truck. Supported by expanding charging infrastructure (including battery-swap stations for trucks), electric truck sales have accelerated sharply in recent years and now rival LNG truck sales. In 2025, for the first time, electric truck sales outnumbered sales of LNG trucks in China, capturing over 25% of the truck market compared to an unchanged 15% share for natural-gas-powered equivalents.

**Electric truck sales grew strongly in Europe and North America but momentum remained weak elsewhere**

In 2025, electric truck (MFT and HFT) sales in **Europe** increased by 40% year-on-year, reaching nearly 17 000 and accounting for 3% of all truck sales in the region.

At the end of 2025, electric HFTs accounted for a sales share of around 1.5% in Europe, up from 1% in 2024, while the share of electric MFTs increased from 5% to 7% over the same period.

Sales growth was supported by EU policy, most notably the HDV [CO<sub>2</sub> standards](#) coming into effect in 2025. These target a 15% emissions reduction for HDVs compared to 2019. The European Union has also encouraged the shift to zero-emission logistics by proposing to extend the road toll [exemption](#) for battery electric and fuel cell trucks (and buses) that has been in place since 2022, and through the [proposed Eurovignette Directive](#) to ensure a consistent application of CO<sub>2</sub>-based charging rules.

**Figure 4.3 Electric heavy freight and medium freight trucks sales shares by region, 2020-2025**

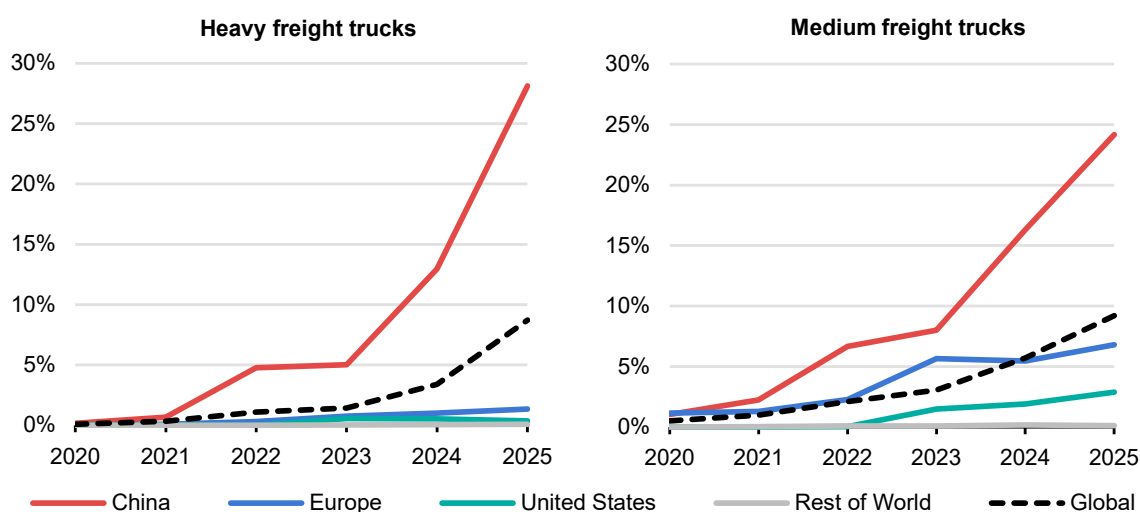

IEA. CC BY 4.0.

Notes: In China, gasoline light-duty trucks and mini trucks are categorised as light commercial vehicles, not trucks. Diesel light-duty trucks are classified as medium freight trucks (defined here as having a gross vehicle weight greater than 3.5 tonnes and less than 15 tonnes).

Sources: IEA analysis based on country submissions and data from [EV Volumes](#) and [CATARC](#).

In **Germany**, Europe's biggest electric truck market, sales increased from 3 400 in 2024 to 4 400 in 2025 (nearly 30% year-on-year growth). The country also [approved](#) EUR 1.6 billion in funding for electric truck charging to support the electrification of trucks, alongside [road toll exemptions](#) for battery electric and fuel cell trucks. Logistics giant DHL, which is headquartered in Germany, announced in 2025 its [aim](#) to electrify 66% of its last-mile fleet by 2030, with Germany being the primary focus for deployment.

The **United Kingdom** led growth in Europe's electric truck sales in 2025, recording growth of more than 55%, with sales topping 3 000. In **France**, sales increased more than 15%, reaching 1 900 in 2025, while in **Sweden**, sales

reached 1 000 trucks, more than doubling year-on-year. This was supported by Sweden's national charging infrastructure [programme](#) for logistics. In **Austria**, a government subsidy covering [80%](#) of additional investment costs for electric trucks has supported a nearly fivefold rise in sales since the policy was first introduced in 2023.

Sales in the **United States** increased 25% to 17 000 in 2025, despite slowing policy momentum. California's Advanced Clean Trucks regulation, which set zero-emissions truck sales requirements, was [revoked](#). In addition, the US Environmental Protection Agency [repealed](#) all GHG emission standards, which had previously regulated improvements for medium- and heavy-duty vehicles. The upward revision for electric truck sales in the United States compared to the previous editions of the Global EV Outlook is mainly as a result of the inclusion of Rivian delivery vans (with a gross vehicle weight of over 3.5 tonnes) in the MFT segment. Driven by its [partnership](#) with Amazon, Rivian sold nearly [10 000](#) electric MFTs in 2025. As such, over 95% of electric truck sales in the United States in 2025 were MFTs. Electric truck sales also increased in **Canada**, by 35%, reaching 2 700 electric trucks in 2025. North America saw a 25% increase in electric truck sales compared to 2024, ending 2025 with 20 000 sales. This is supported by strong model availability, particularly for battery electric MFTs.

In the rest of the world, electric truck sales dropped in 2025, falling by 15% to 1 900 and reversing several years of growth – sales had increased by 50% in 2023 and more than 75% in 2024. The drop in sales at the global level was despite **India's** electric truck registrations increasing from 200 in 2024 to around 800 units.

Nevertheless, the purchase price of electric trucks remains [two to three times](#) higher than of diesel trucks. This presents a barrier to uptake, especially for smaller fleet operators, even when the TCO is favourable. Purchase subsidies, leasing mechanisms, CO<sub>2</sub>-charting road tolls, financial support mechanisms across the electric truck supply chain, concessional finance and government-backed credit, asset utilisation and residual value guarantees can help increase [adoption](#) in nascent electric truck markets. Policy measures could also address the payload limitations of electric trucks that result from their large batteries and can [limit](#) their cargo capacity. In some cases, this limitation may require additional vehicle movements, hence increasing the costs, particularly for low-volume and high-weight freight. It has been [estimated](#) that by relaxing weight limits by 2 tonnes, battery electric trucks in India may reach TCO parity with diesel alternatives 2 to 3 years sooner. The European Union is [considering](#) a further increase in weight and length limits for zero-emissions trucks, which already benefit from an additional 2 tonne [allowance](#). However, excessively heavy vehicle weights and large truck dimensions pose the risk of damage to infrastructure.

Q Will trucks electrify quicker than cars?

As electric cars become more mainstream, attention is turning to how quickly the world's second-largest oil-consuming transport mode – trucks – can electrify. Trucks are a critical component of modern supply chains and are major oil consumers, exceeding the energy demand of the aviation and shipping sectors combined. The extent and speed of truck electrification therefore has significant implications for global oil markets.

As recently as 2020, the electric truck sales share globally was below 0.5%, and many viewed truck electrification as particularly difficult, potentially requiring innovative technologies such as solid-state batteries. By 2025, however, electric truck sales had reached almost 9% globally – and over 25% in China – by relying on lithium-ion batteries, the same technology used in passenger cars. In December 2025, the electric heavy-duty truck sales share in China even hit around 50%. Although this was partly due to a sales rush in anticipation of expected policy changes, this recent surge in electric truck adoption could indicate a profound shift in the Chinese truck market – with implications for truck electrification elsewhere.

**SALES SHARE OF ELECTRIC TRUCKS IN CHINA SINCE BECOMING COMPETITIVE ON TOTAL COST OF OWNERSHIP**

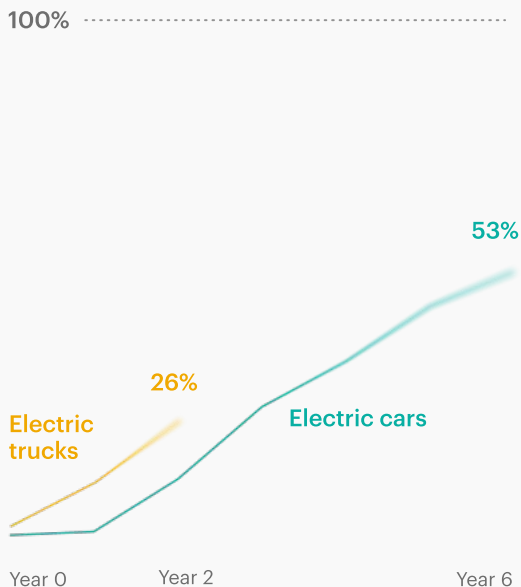

**STOCKS AND SALES SHARE OF ELECTRIC TRUCKS, EUROPEAN UNION AND CHINA**

■ 15 k → 2.3% ■ 32 k European Union → 3.5%



Electric trucks remain around two to three times more expensive to purchase than their diesel counterparts, posing financing challenges, particularly for smaller businesses. However, for commercial fleets, the total cost of ownership (TCO), or how much it costs to purchase, deploy and manage a truck over the full ownership period, is often more important than upfront price, as fleets are tightly optimised to minimise operating costs. In China, battery electric trucks already have a lower TCO than diesel models, even for heavy-duty applications with daily driving distances of 500 km, creating a strong economic incentive to switch to electric. This is not yet the case in the European Union, currently another of the world's largest electric truck markets, but TCO parity is expected there before 2030. Adequate charging infrastructure is equally essential, and China has moved early by deploying public truck chargers – with an estimated 70 000 charging points at the end of 2025 – as well as battery swap stations.

Electric trucks require multiple enabling conditions – technology readiness, competitive TCO, access to financing and reliable charging infrastructure – before deployment can scale. When these elements align, however, adoption can accelerate suddenly, potentially more rapidly than in consumer-driven markets such as electric cars.

## The expanding range of electric heavy-duty models increasingly meets additional operational needs

There is currently no harmonised regulatory regime for measuring the actual range of electric HDVs across different countries and regions. Nonetheless, the average self-declared range of battery electric HDV<sup>18</sup> models has increased by more than 10% since 2020. Further progress may have been hindered by the fact that increasing the battery size in electric trucks can be limited by payload economics in some cases.

Today, the average range of available battery electric bus models has reached 360 km – around 15% more than in 2020. This range is already sufficient to cover the mileage needs of urban buses, that drive on average [150-300 km](#) per day. However, few battery electric bus models available today can cover the range needs of intercity buses, which can reach up to [800 km](#) per day. [King Long](#) already offers electric intercity buses that have 650 km range. In 2025, [Volvo](#) unveiled an electric bus chassis that enables ranges of up to 700 km, nearing the upper-limit range requirements for today's conventional intercity buses. The range of launched models is also influenced by developments in charging infrastructure and charging times, as well as by the share of battery-swap-capable trucks. On average, the driving range of a battery electric bus on a single charge is around 35% higher than that of an MFT, and around 20% higher than an HFT.

In 2025, the average self-declared range of available battery electric MFT models reached 270 km, while that of HFT models neared the 310 km mark. This represents an increase of around 20% and 5%, respectively, since 2020, and announcements made by large original equipment manufacturers (OEMs) are indicating that they are targeting further range growth in the coming years. Volvo has announced the [launch](#) of an electric HFT with 600 km range in the second quarter of 2026, while [Renault](#) recently unveiled an electric truck model capable of the same driving range. China's [Sany](#) already offers an electric HFT model that is able to drive for over 800 km on a single charge, and [Tesla](#) claims it will start deliveries of an 800 km-capable semi-trailer truck in 2026. These ranges already respond to many long-haul drivers' daily needs, which average [400-1 000](#) km. For MFTs, 25 battery electric models, representing more than 10% of all battery electric MFT models – mostly by Chinese OEMs – already offer at least 400 km driving range from a single charge.

---

<sup>18</sup> This classification includes medium- and heavy- freight trucks as well as buses.

**Figure 4.4 Average self-declared range of available battery electric heavy-duty vehicle models by segment, 2020-2025**

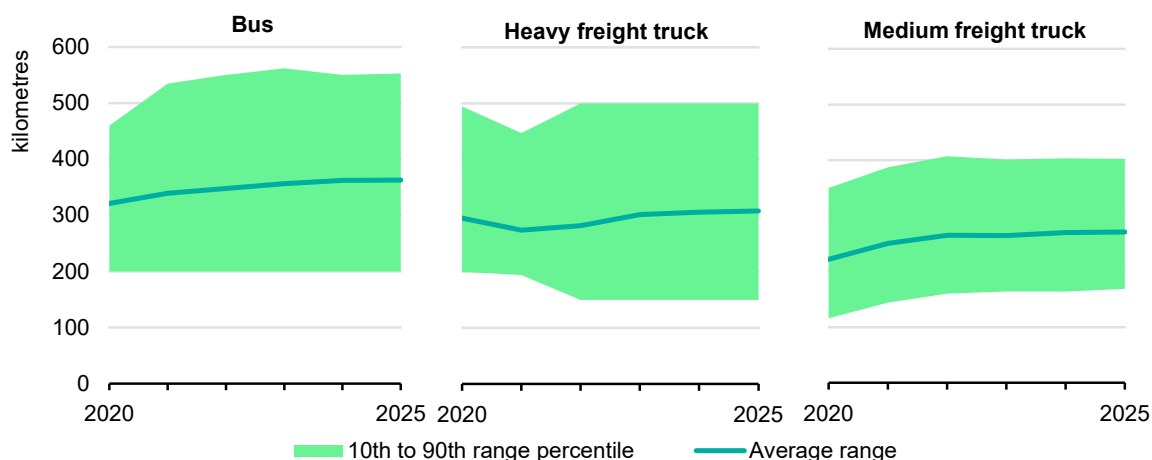

IEA. CC BY 4.0.

Notes: Buses with 25 seats or fewer and light commercial vehicles, which have a gross vehicle weight of less than 3.5 tonnes, are excluded from this analysis. Calculation is a battery range average of available models per heavy-duty vehicle segment. Battery ranges used are stated operational ranges provided by manufacturers.

Source: IEA analysis based on the [Drive to Zero ZETI tool](#).

## Electric heavy-duty model availability

### The number of battery electric heavy-duty vehicle models saw little change in 2025

Despite growing demand, the total number of battery electric heavy-duty models available worldwide increased by only 6 models in 2025 (or 1%), resulting in global model availability remaining around 800. This represents the lowest number of model increases since 2018. Fewer than 20 new models were introduced in 2025 – a 90% drop year-on-year, compared to an increase of around 75% for battery electric car models, at the same time as some models were discontinued. More than 130 models were discontinued worldwide in the 2024-25 period. Two-thirds of these discontinued models were from Chinese manufacturers, some a result of consolidation or rebranding. Despite this, the total number of models available in China has increased by almost 50 since 2023, and all Chinese manufacturers that offered models in 2023 either increased or maintained their model availability through 2025.

The remaining model cancellations in the 2024-25 period occurred mainly in the United States, Canada and Europe, where multiple smaller start-ups filed for bankruptcy amid sluggish sales and the need for substantial upfront investments. In late 2024, both Canadian electric HDV manufacturer [Lion Electric](#) and German heavy-duty zero-emissions vehicle manufacturer [Quantron](#) filed for bankruptcy, discontinuing 19 battery electric HDV models between them. Sweden-founded [Volta Trucks](#) filed for bankruptcy for the second time in 2025, as did US-based [Nikola Corporation](#) in early 2025.

**Figure 4.5 Battery electric heavy-duty vehicle model availability by original equipment manufacturer headquarters, 2020-2025**

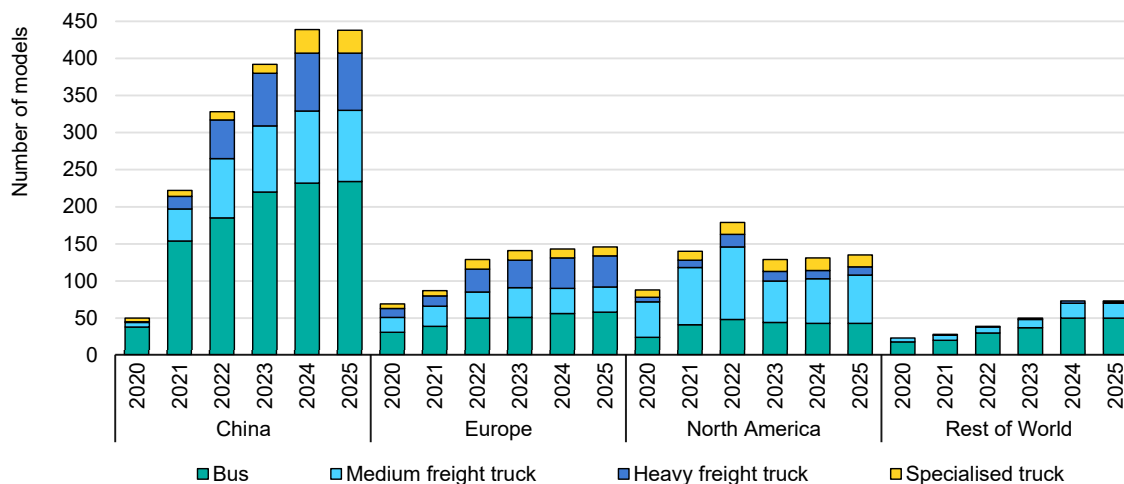

IEA. CC BY 4.0.

Note: Buses with 25 seats or fewer and light commercial vehicles, which have a gross vehicle weight of less than 3.5 tonnes, are excluded from this analysis.

Source: IEA analysis based on the [Drive to Zero ZETI tool](#).

The market with the most battery electric models available is **China**, with almost 450 – half of which are buses, whose uptake is supported by [subsidies](#). Chinese automakers are also expanding battery electric HDV model availability in emerging markets and developing economies (EMDEs), particularly for buses. There are now ten Chinese OEMs selling battery electric HDVs in Africa and Latin America. With recent entries by [Shudu](#) and [King Long](#), alongside more established OEMs such as [BYD](#) (which has been selling electric HDVs in Brazil for over a decade), a total of 20 models by Chinese OEMs were on offer in these economies in 2025. Available models from OEMs based in EMDEs have also increased steadily over the years, reaching more than 25 in 2025, with India's automakers offering the largest number of models.

**Europe** has nearly 150 models available, with a balanced mix of buses and trucks. Major European bus and truck manufacturers [IVECO](#) and [MAN](#) released new models in 2025. North American OEMs have more than 130 models in their line-ups, down from a high of 180 in 2022. This decline in available models followed the acquisition of [SEA Electric](#) in 2024, which shifted its focus to providing propulsion systems to other OEMs. The majority of models available in the **United States** and **Canada** are medium freight trucks, which typically have shorter and more predictable routes that are suitable for battery-powered models. Costs, weight and charging infrastructure requirements are also often easier to manage for smaller electric freight trucks. This is reflected in US [price trends](#) – while smaller electric trucks are becoming more affordable, heavy freight models have seen price increases since 2020. Five more battery electric medium freight

truck models became available in North America in 2025, more than any other segment in a major market, with [Harbinger](#) accounting for most of the new models.

## The number of models offered per manufacturer has grown steadily in China and Europe

Although the number of battery electric HDV (medium and heavy freight trucks and buses) models available in China is more than three times higher than in North America, there are more OEMs making battery electric HDVs headquartered in North America than in China. Almost one-third of the 150 battery electric HDV manufacturers worldwide in 2025 were headquartered in North America. However, many of these are smaller start-ups, offering on average just three battery electric HDV models. In comparison, China is home to 40 OEMs making battery electric HDVs, and there has been almost no increase in the number of companies since 2022, indicating greater market maturity, growing consolidation and barriers to entry due to competition. The gradual increase in the average number of models offered by OEMs headquartered in Europe could also indicate similar trends.

The number of OEMs making electric HDVs headquartered in EMDEs including India and countries in South America and Africa has grown steadily, expanding the number of models available. Globally, the average number of models per OEM has increased steadily since 2020 to more than 5 in 2025.

**Figure 4.6 Average number of battery electric heavy-duty vehicle models per original equipment manufacturer by location of headquarters, 2020-2025**

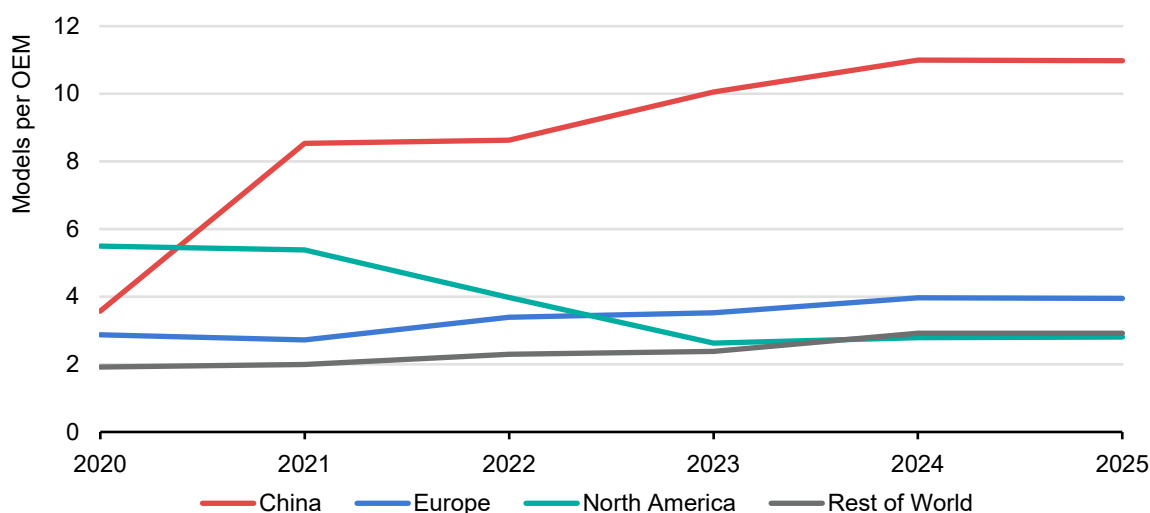

IEA. CC BY 4.0.

Notes: OEM = original equipment manufacturer. All OEMs with at least one battery electric heavy-duty vehicle model in the database are included. Buses with 25 seats or fewer and light commercial vehicles, which have a gross vehicle weight of less than 3.5 tonnes, are excluded from this analysis.

Source: IEA analysis based on the [Drive to Zero ZETI tool](#).

### Box 4.2 Deployment of fuel cell electric vehicles in 2025

The fuel cell electric vehicle (FCEV) stock increased almost 20% in 2025. More than half of the growth was driven by uptake of fuel cell trucks in China, while fuel cell car and fuel cell bus sales in Korea accounted for most of the rest of 2025 stock expansion.

In 2025, China surpassed Korea in terms of total FCEV stock, representing more than one-third of the global fuel cell vehicles fleet. The Chinese FCEV stock grew 30% year-on-year, in large part supported by a significant increase in fuel cell truck sales, exceeding the 10 000 mark in 2025. Despite their stock increasing markedly in 2025, fuel cell trucks only accounted for less than 1% of truck sales in China, compared to more than 25% for their battery electric counterparts.

#### Fuel cell electric vehicle stock by segment and region, 2020-2025

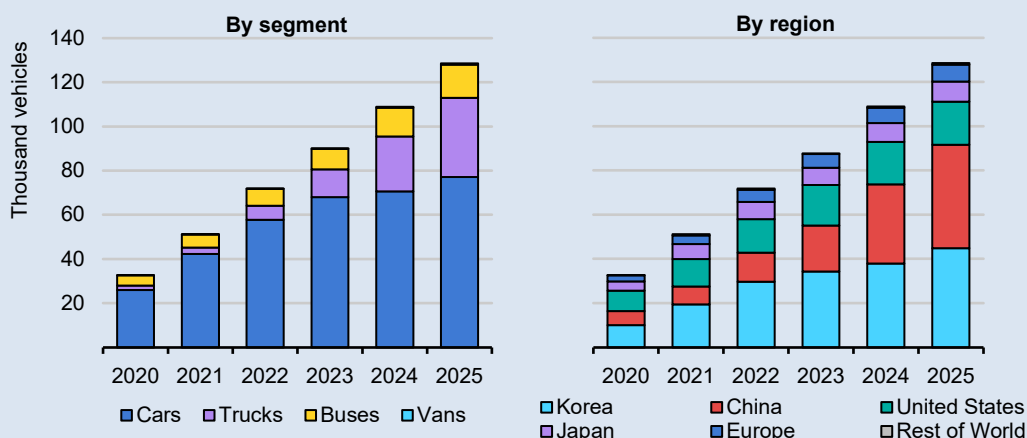

IEA. CC BY 4.0.

Sources: IEA analysis based on data from the [Advanced Fuel Cells Technology Collaboration Programme](#), [CATARC](#), [AIRIA](#), [EV Volumes](#), [Toyota](#), [California Fuel Cell Partnership](#).

Fuel cell trucks currently have higher purchase prices and operating costs than battery equivalents in China, so uptake was mostly driven by policy support. This takes the form of incentives provided to hydrogen corridors and [city clusters](#) to reach vehicle deployment, charging infrastructure and hydrogen price benchmarks in order to qualify for vehicle purchase subsidies and support for rolling out refuelling infrastructure. In April 2025, the third subsidy round for the FCEV demonstration projects was [announced](#). The programme, with a budget of up to CNY 9.35 billion Yuan renminbi (USD 1.3 billion), supports [China's target](#) to reach 100 000 FCEVs on its roads by 2030.

In Korea, Hyundai [released](#) the second generation of its flagship fuel cell car model, the Nexo, which became a strong contributor to the doubling in Korea's fuel cell car sales in 2025, and represented the majority of the growth in new sales of fuel cell cars globally. Sales in other parts of the world paled in comparison, failing to exceed 1 000 in 2025. Korea also saw the world's largest increase in new fuel

cell bus sales, with its bus fleet growing nearly 70% in 2025. This translated into a fleet of almost 3 000 buses, meeting about 10% of Korea’s 2030 deployment [target](#).

To meet demand from a growing number of FCEVs, countries have supported the build-out of hydrogen refuelling stations (HRSs). The number of operational stations worldwide reached more than 1 300 at the end of 2025, a roughly 10% increase from 2024. China saw the largest number of new HRSs, increasing 15% in 2025 to reach more than 600. In Europe, station [closures](#) in countries including [Austria](#), [Germany](#), [Norway](#) and the [United Kingdom](#) brought the HRS count down by about 10% in 2025, bringing the total to below 170 stations. In contrast, Korea saw a significant increase in HRSs over 2025, far exceeding Europe’s deployment levels with nearly 270 stations. The number of operational HRSs in the United States also fell in 2025 and remained below the number available between 2017 and 2022.

**Number of hydrogen refuelling stations by region and ratio of fuel cell electric vehicle stock to number of stations, 2020-2025**

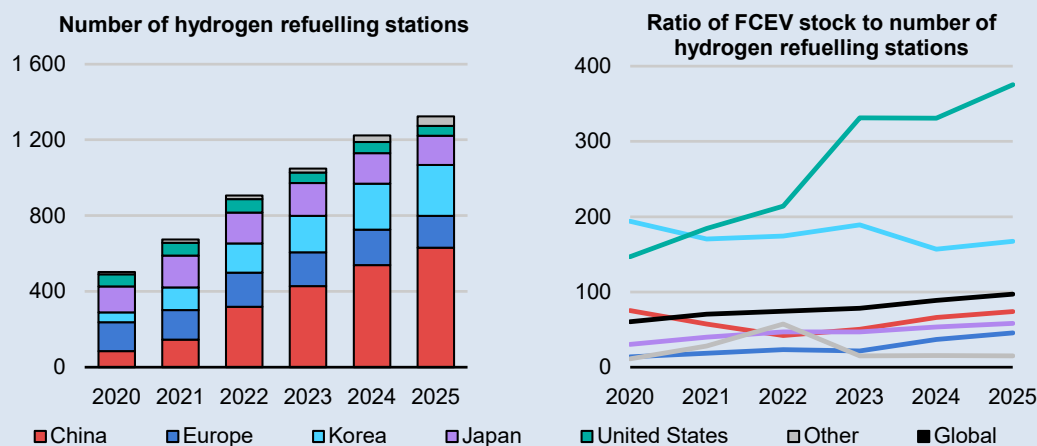

IEA. CC BY 4.0.

Note: FCEV = fuel cell electric vehicle.

Sources: IEA analysis based on data from the [Advanced Fuel Cells Technology Collaboration Programme](#); [European Hydrogen Observatory](#); [US Alternative Fuels Data Center](#); [Korea, Ministry of Climate, Energy and Environment](#).

The number of FCEVs per HRS is significantly higher in the United States and Korea than in other regions. The global average was around 100 FCEVs per HRS in 2025.

For further information on the deployment status of FCEVs and other hydrogen-based technologies, see the IEA [Global Hydrogen Review](#) report series.

# Chapter 5. Trends in electric vehicle batteries

## Electric vehicle battery deployment

### Electric vehicle battery deployment grew by almost 30% in 2025

Electric vehicles (EVs) remained the primary source of global battery deployment, accounting for more than 70% of the total in 2025, slightly down from almost 80% in 2024. In 2025, EV battery deployment reached 1.2 TWh, an increase of almost 30% compared to 2024, and more than 7 times greater than in 2020. Light-duty vehicles remained the dominant segment, representing more than 85% of the 2025 EV battery deployment. However, the fastest growth came from electric trucks, for which battery demand more than doubled – largely thanks to a sharp acceleration in sales in the People’s Republic of China (hereafter, “China”) (see [One in four trucks sold in China in 2025 was electric](#)). As a result, electric trucks accounted for about 8% of global EV battery deployment in 2025, up from less than 5% in 2024.

**Figure 5.1. Electric vehicle battery deployment by mode and region, 2020-2025**

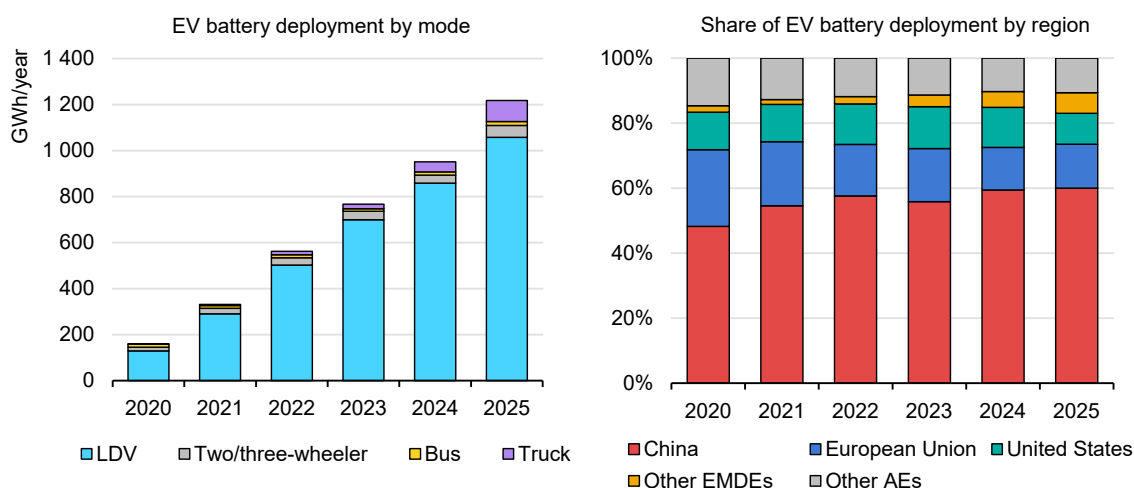

IEA. CC BY 4.0.

Notes: LDV = light-duty vehicle, including cars and vans; EMDEs = emerging markets and developing economies; AEs = advanced economies. Battery deployment is defined as the volume-weighted average battery size multiplied by vehicle sales by mode and region.

Sources: IEA analysis based on country submissions and data from the [European Automobile Manufacturers Association \(ACEA\)](#), [European Alternative Fuels Observatory \(EAFO\)](#), [Marklines](#) and [EV Volumes](#).

Regionally, EV battery deployment<sup>19</sup> expanded in China (60% of global) and the European Union (almost 15%) in 2025, while it stagnated in the United States (10%). Growth in emerging markets and developing economies (EMDEs) other than China also continued – they represented 6% of global EV battery deployment in 2025, highlighting the increasingly global nature of road transport electrification.

In 2025, the average battery size of battery electric cars remained broadly stable in the European Union and China, at close to 70 kWh and below 60 kWh, respectively. By contrast, average plug-in hybrid electric car battery sizes increased by almost 10% in China, to reach more than 25 kWh, and by almost 15% in the European Union, reaching just over 20 kWh. In the United States, average battery sizes for both battery electric and plug-in hybrid electric cars grew at a similar pace of around 5%, reaching 90 kWh for battery electric cars and less than 20 kWh for plug-in hybrid electric cars.

**Figure 5.2. Average electric car battery pack size by region and powertrain, 2015-2025**

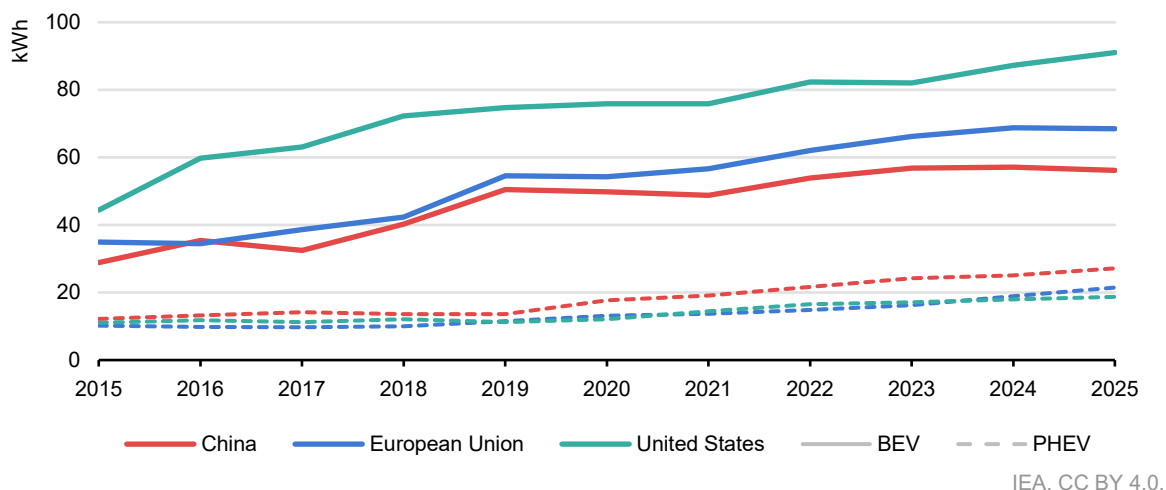

Notes: BEV = battery electric vehicle; PHEV = plug-in hybrid electric vehicle. Solid lines represent the sales-weighted average battery pack size for battery electric cars, while dashed lines indicate the same for plug-in hybrid electric cars. Source: IEA analysis based on [EV Volumes](#).

## Battery industry trends

### Battery prices continued to decrease, albeit unevenly

Average battery prices declined by 8% in 2025, supported by continued improvements in manufacturing efficiency, advances and shifts in battery chemistries and technology, and intensifying global market competition (see

<sup>19</sup> EV battery deployment is calculated as the volume-weighted average battery size multiplied by vehicle sales by mode and region.

[Battery manufacturing and trade](#) for more details). Relatively low critical mineral prices also contributed to downward cost pressure, although lithium and cobalt experienced notable price increases over the year. The recent increase in lithium and cobalt prices – if sustained – could put upward pressure on battery costs as stockpiles of minerals purchased at lower prices are being drained.

Lithium prices at the beginning of 2026 were more than twice as high as in the same period in 2025, even though they remained around 70% lower than their 2022 peak. Several factors contributed to this rise, including faster-than-anticipated demand growth – particularly from the battery energy storage sector –, relatively [low inventories](#) in China and temporary supply disruptions, such as the [suspension](#) of operations at CATL’s Jianxiawo lithium mine. If these upward price trends persist, they could exert upward pressure on lithium-ion battery prices and reinforce the current [momentum](#) behind [sodium-ion batteries](#), which offer [lower](#) ranges but do not rely on lithium. This effect could nevertheless be tempered by existing long-term contracts for lithium supply and vertical integration among major battery producers.

**Figure 5.3. Price index of selected battery metals (left) and lithium-ion battery packs (right), 2015-2026**

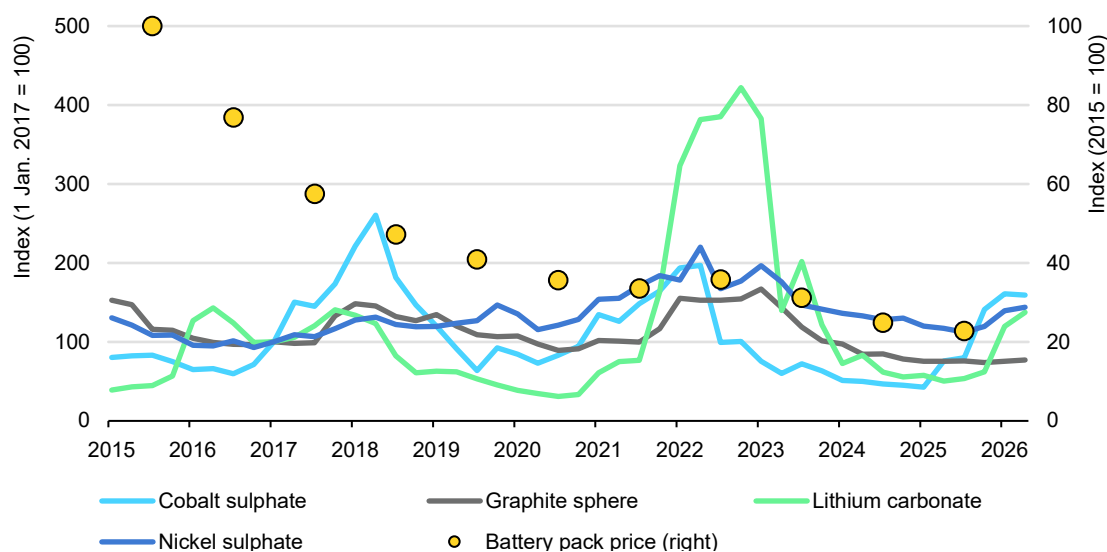

IEA. CC BY 4.0.

Notes: “Battery pack price” refers to the volume-weighted average pack price of lithium-ion batteries across the electric vehicle and battery storage sectors. Data are reported for average monthly prices for January, April, July and September of each year. 2026 reports data up to the end of March 2026.

Sources: IEA analysis based on data from [Bloomberg](#) and [Bloomberg New Energy Finance](#).

Cobalt prices also doubled over the past year, principally following the Democratic Republic of the Congo’s (DRC) temporary [export ban](#) announced in late February 2025, which was later [converted](#) into export quotas starting from 16 October 2025. Given that the DRC accounts for almost two-thirds of global cobalt supply, these policy shifts had a significant and [swift impact](#) on market prices. Yet the effect of cobalt price fluctuations on overall EV battery costs is far more limited today than

in the past. High-nickel chemistries rely on relatively small quantities<sup>20</sup> of cobalt, and lithium iron phosphate (LFP) batteries contain none – together, these chemistries account for the vast majority of today’s EV battery market.

Record low LFP battery prices also contributed significantly to overall battery price reductions in 2025. In 2025, LFP battery packs were more than 40% cheaper on average than lithium nickel manganese cobalt oxide (NMC) alternatives per kWh, although part of this cost advantage reflects the lower energy density requirements of stationary storage applications, which predominantly use LFP.<sup>21</sup> While LFP batteries benefit from structurally lower material costs, there are [growing concerns](#) about the sustainability of today’s price levels. Many cathode active material producers are currently operating at a loss (see Figure 5.7) while continuing to expand manufacturing capacity, increasing the risk of market consolidation. This risk may be reduced if cathode producers are able to gain pricing power, but either of these outcomes would put upward pressure on battery production cost.

Over the past few years, the average battery price has decreased across all regions, but regional price disparities have widened. In 2025, battery pack prices in China were 30% lower than in North America, and 35% lower than in Europe, compared to a respective 20% and 25% in 2022.

**Figure 5.4. Average battery pack price index by battery chemistry and region, 2020-2025**

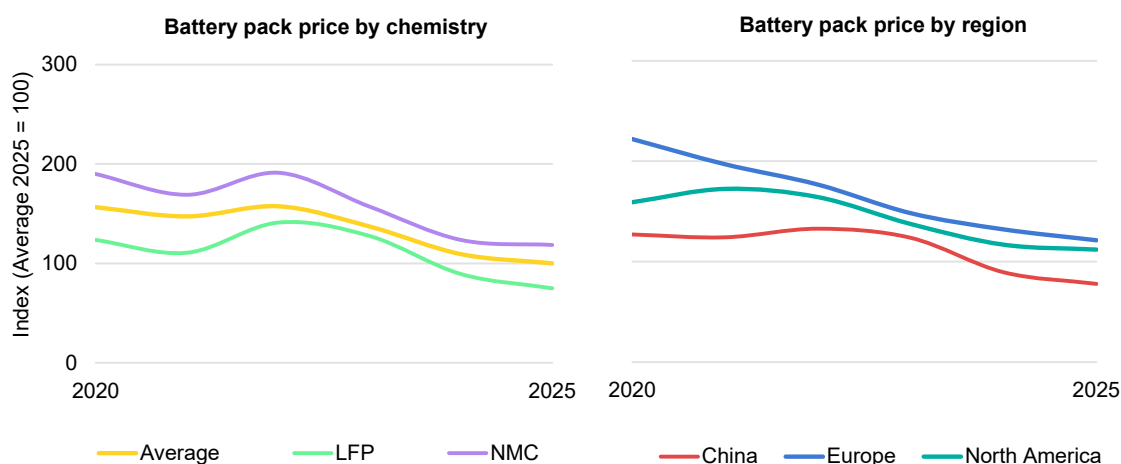

IEA. CC BY 4.0.

Notes: LFP = lithium iron phosphate; NMC = lithium nickel manganese cobalt oxide; Average = average across electric vehicles (EVs) and battery storage applications and chemistries. Battery pack price refers to price per kWh. Battery prices by region refer to the average battery price in a given region, including locally produced batteries and imports across EVs and battery storage applications.

Source: IEA analysis based on data from Bloomberg New Energy Finance.

<sup>20</sup> NMC721 and NMC811, both containing around 10% cobalt in their metal content (excluding lithium), together with lithium nickel cobalt aluminium oxide (NCA) (15%), accounted for roughly 80% of 2025 EV battery deployment using cobalt-containing chemistries.

<sup>21</sup> LFP accounted for over 90% of global stationary battery storage installations in 2025, representing roughly 40% of total LFP battery deployments across all applications in that year.

## Lithium iron phosphate now accounts for over half of the EV market, driven by China and emerging markets

In 2025, LFP batteries accounted for over 55% of EV batteries deployed globally, up from nearly 50% in 2024. Deployment remains heavily concentrated in China, but uptake is also expanding rapidly in other EMDEs. LFP batteries now power two-thirds of all electric car sales in these economies – double the share in 2023 – driven by imports of Chinese-manufactured vehicles and batteries.

**Figure 5.5. Share of electric vehicle battery sales by chemistry and region, 2023-2025**

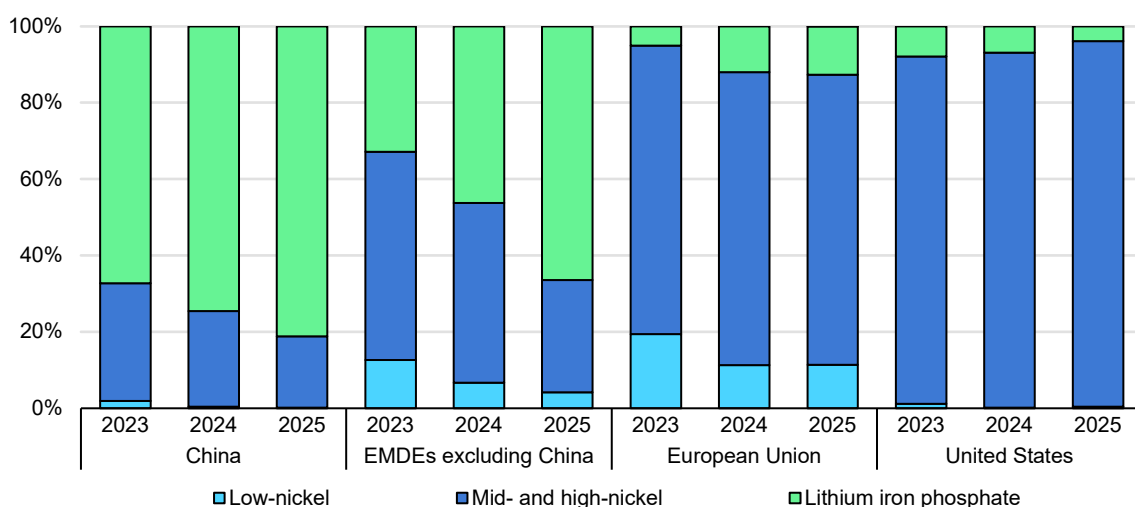

IEA. CC BY 4.0.

Notes: EMDEs = emerging markets and developing economies. Two/three-wheelers are excluded from the analysis. Low-nickel includes lithium nickel manganese cobalt oxide (NMC) 333, NMC442, and NMC532. Mid- and high-nickel includes NMC622, NMC721, NMC811, lithium nickel cobalt aluminium oxide (NCA), and lithium nickel manganese cobalt aluminium oxide (NMCA). Lithium iron phosphate also includes lithium iron manganese phosphate. Battery chemistry sales share is based on the battery capacity of new electric vehicles registered.

Sources: IEA analysis based on data from [EV Volumes](#) and [China Automotive Battery Industry Innovation Alliance](#).

LFP batteries can reduce EV production costs, but their deployment remains mainly concentrated in China, where Chinese companies lead in LFP battery and materials [production](#) and [innovation](#).

In the European Union, LFP batteries accounted for more than 10% of EV battery demand in 2025, a similar level to 2024. Nearly all of these batteries were imported from China, either directly (30%) or embedded in LFP-equipped EVs (nearly 70%).

In the United States, the share of LFP in EV batteries almost halved in 2025 from an already low base in 2024, reflecting higher tariffs on Chinese imports and [more stringent](#) sourcing requirements linked to the EV tax credit that was available [until the third quarter](#) of 2025. In 2025, over 50 GWh of battery manufacturing capacity, belonging to companies such as [LG Energy Solution](#) (LGES) and [Ford](#), was reallocated toward LFP production. This underscores efforts to onshore this technology, albeit largely [targeting](#) the battery energy storage market, which is increasingly attracting the attention of battery producers that invested in the

United States over the past years. Battery stationary storage accounted for one-third of battery deployment<sup>22</sup> in the United States in 2025, and its role is growing as deployments expand across power grids and data centres.

Efforts to onshore LFP battery production represent an important first step to diversifying supplies, but the underlying supply chain remains a critical constraint. Production of LFP cathode materials and their precursors is still almost entirely concentrated in China (Figure 7.15), which holds the associated manufacturing capacity and the technical expertise. Some [diversification](#) options are being developed, such as [Korean](#) and [Japanese](#) producers [investing](#) in the technology, as well as an LFP [production base](#) being [built](#) in Indonesia. However, changing this structural imbalance will require substantial investments and stronger international co-operation across the entire battery value chain.

**Figure 5.6. Battery manufacturing capacity that has been added, cancelled and reallocated by region and chemistry, 2024-2025**

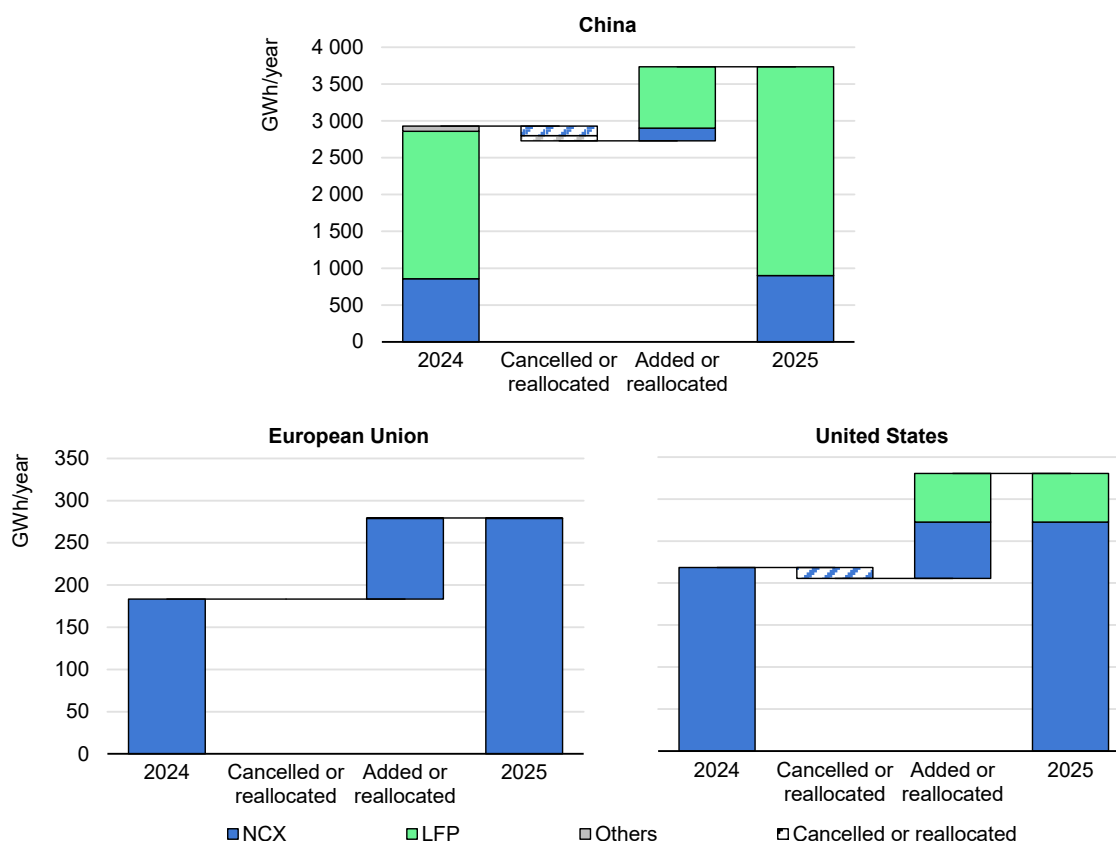

IEA. CC BY 4.0.

Notes: NCX = lithium nickel cobalt X, including lithium nickel cobalt aluminium oxide (NCA) and all lithium nickel manganese cobalt oxide (NMC). LFP = lithium iron phosphate. Others include lithium cobalt oxide and lithium manganese oxide. Manufacturing capacity refers to electric vehicles and battery storage applications.

Source: IEA analysis based on data from [Benchmark Mineral Intelligence](#).

<sup>22</sup> Accounting for electric vehicle batteries and battery storage systems.

## Narrow profit margins are challenging some major battery and materials producers, but not all are affected equally

Among the major global battery manufacturers, Korean producers have experienced sustained pressure on profitability in recent years, with some – notably SK On – reporting recurring operating losses. By contrast, CATL, the world’s largest battery producer, has maintained strong profitability, recording operating margins of 10-15% each year between 2020 and 2024, and 18% in 2025. At the same time, CATL’s overseas activities continued to grow in importance – in their [2025 interim report](#), they indicated that almost 35% of revenue came from overseas activity, up from 30% in the same period of 2024. The battery business of Panasonic, the largest Japanese battery maker, has also maintained sustained profit margins, reaching 10% in 2024 and 14% in 2025, although overall volumes are significantly lower. CATL revenues were slightly larger than the combined revenues of LGES, Samsung SDI, SK On and Panasonic Energy in 2024, roughly 40% larger in 2025,<sup>23</sup> and continued to [grow](#) rapidly in the first quarter of 2026.

A concerning trend is that profitability for several leading non-Chinese producers has increasingly depended on policy support over the past years. Companies such as LGES and Panasonic Energy benefited significantly from production tax credits in the United States. It was [reported](#) that in 2024, both companies would have achieved negative operating margins without these credits, suggesting that tax incentives were the decisive factor keeping operations in positive territory. For example, LGES [reported](#) earnings before interest and taxes (EBIT) of more than USD 400 million in 2024, but without US tax credits, the EBIT would have been negative, at around -USD 650 million. In [2025](#), it would have been -USD 200 million. At the same time, these battery producers invested heavily in new manufacturing capacity, particularly in North America. For example, LGES’s annual capital expenditure rose from around USD 3 billion in 2021 to approximately USD 9 billion in 2024, decreasing to about USD 7.5 billion in 2025.

The exposure of Korean and Japanese battery manufacturers to the US market has proven successful in the past years, but it could now place significant stress on their operations. Although the advanced manufacturing production tax credits [remain available](#), accessing these incentives will become increasingly challenging. Eligibility requirements are set to tighten in the coming years, entailing further investment to develop supply chains that are less dependent on China. At the same time, recent policy developments have undermined expectations for future EV battery demand, making it more difficult for producers to justify the additional investments required. In addition, several automakers have [scaled back](#) or

---

<sup>23</sup> Excluding non-battery related activities of SK On after its [merger](#) with SK Enmove in 2025.

[withdrawn](#) from supply deals or joint battery-manufacturing initiatives, leaving future investment burdens to battery producers alone.

Battery storage systems are [helping](#) absorb the reduced EV-related demand in the United States, with battery producers increasingly shifting their focus on this segment for the US market. However, battery storage systems are not likely to provide a long-term solution, as future global battery demand – much like [today](#) – is projected to continue to be driven primarily by EV deployment.

The combination of stricter regulatory requirements, softer demand projections and reduced industry partnerships heightens financial and operational risks for manufacturers that have invested heavily in the United States and that are facing tightening margins – with the Korean government recently calling for [restructuring](#) of the Korean battery industry.

**Figure 5.7. Revenue and profit margins of selected battery and cathode active material producers, 2021-2025**



Notes: Battery and cathode active material producers were selected as the largest ones reporting battery-specific financial data (such as through specific subsidiaries). 2025 data for SK On are not reported because of lack of battery-specific data after the merger with SK Enmove in 2025.

Source: IEA analysis based on data from [S&P Global](#).

IEA. CC BY 4.0.

Today's record low battery prices are partly sustained by losses incurred further upstream in the supply chain, particularly among producers of cathode active materials (CAMs). Cathode active material is the single most important component influencing battery cell production costs, accounting for 40-50% for NMC batteries and 25-30% for LFP batteries.<sup>24</sup> Yet many of the leading CAM producers have been operating at a significant loss since 2023.

This challenging market environment is not limited to NMC material producers, whose demand outlook has been dampened by the rapid rise of LFP batteries in recent years. LFP producers in China are also experiencing sustained losses, with the exception of Hunan Yuneng, the world's largest LFP material supplier. These conditions are unlikely to be sustainable in the long term. They could trigger consolidation in the LFP material market, increasing its market concentration, or lead to greater pricing power among remaining producers. Either outcome could exert upward pressure on battery prices.

The current unattractive investment environment also poses risks for [companies](#) seeking to [diversify](#) and expand the LFP value chain. Diversification would bring significant advantages from a market resilience perspective, as today the LFP CAM market is [almost entirely](#) concentrated in China. However, the risks associated with low or negative profit margins and intense competition, combined with high market concentration, are making raising finance and investment in those sectors more difficult. These risks are shared across other parts of the midstream lithium-ion battery supply chain, which are also in stark need of diversification (see Figure 7.15).

## Emerging battery chemistry and designs

### Sodium-ion batteries are entering the scale-up phase

The first [sodium-ion battery-powered](#) electric car was [introduced](#) in China only in late 2023, but the technology is now being scaled up by leading battery producers such as [CATL](#) and [BYD](#). Sodium-ion batteries perform significantly better at low temperatures than lithium-ion batteries, particularly LFP chemistries. The latest generation of sodium-ion batteries can retain around 90% of nominal capacity at temperatures as low as [-40°C](#), and can operate at temperatures as high as [70°C](#). For the largest battery manufacturers, who can maintain multiple supply chains in parallel, expertise and production capacity for sodium-ion batteries can also help to reduce exposure to lithium price spikes.

Despite recent progress, sodium-ion batteries remain constrained by lower energy density than lithium-ion technologies, limiting their competitiveness with LFP

---

<sup>24</sup> Shares refer to average battery cell production cost in China in 2024.

batteries at current lithium prices. The latest sodium-ion cells can reach up to [175 Wh/kg](#), compared with up to [205 Wh/kg](#) for the latest generation of LFP batteries and [265 Wh/kg](#) for lithium nickel cobalt manganese oxide (NMC) batteries. Their disadvantage is even greater in terms of volumetric energy density (Wh/l), which translates into a [driving range](#) of up to 350 km for an average SUV equipped with a sodium-ion battery, compared with a range of 400-600 km for lithium-ion batteries under average weather conditions.

Sodium-ion batteries are therefore expected to be better suited for small-range electric cars, [light commercial vehicles](#) operating in urban areas, [two- and three-wheelers](#), industrial equipment such as [forklifts](#), and battery [stationary storage](#). They can also help reduce range losses in cold weather when used in [hybrid](#) EV battery packs combining lithium-ion and sodium-ion chemistries.

Global supply chains for sodium-ion batteries are also far less developed than for lithium-ion batteries, limiting the near-term prospect of large-scale deployment. For example, the supply chain of hard carbon – the anode active material used in sodium-ion batteries as a substitute for graphite – is still [poorly](#) developed today and largely concentrated in China. Battery manufacturing capacity is also significantly smaller. Current sodium-ion battery cell manufacturing capacity is equal to just over 1% of that of lithium-ion cells, and announced projects for 2030 amount to only about 7% of the committed lithium-ion manufacturing capacity for the same year.

**Figure 5.8. Sodium-ion battery installed and announced manufacturing capacity by chemistry and region, and comparison with lithium-ion battery manufacturing capacity, 2025 and 2030**

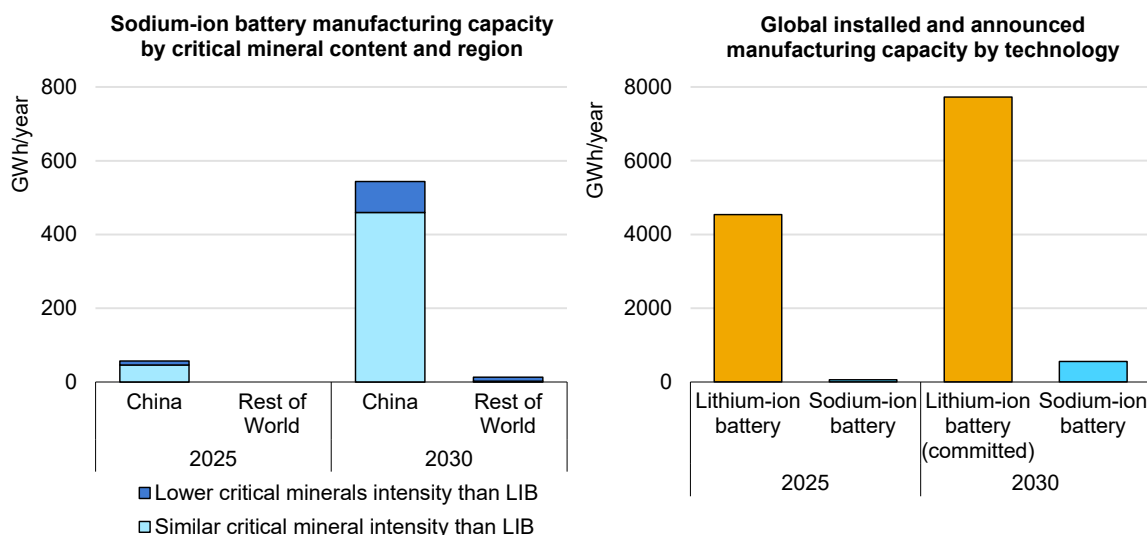

IEA. CC BY 4.0.

Notes: LIB = lithium-ion batteries. GWh/year refers to the nameplate manufacturing capacity. Manufacturing capacity refers to battery cells. “Similar critical mineral intensity to LIB” refers to all layered oxide cathode materials. “Lower critical minerals intensity than LIB” refers to polyanionic and Prussian-blue analogue (PBA) cathode materials. Some polyanionic and PBA chemistries can still contain notable amounts of critical minerals – for example manganese for PBAs or vanadium for polyanionics – but typically less than layered oxides. Manufacturing capacities in the chart to the right refer to all lithium-ion battery and all sodium-ion battery chemistries.

Source: IEA analysis based on data from [Benchmark Mineral Intelligence](#).

## Solid-state batteries are progressing, but still need to be demonstrated at scale

Solid-state batteries (SSB) have attracted attention and investment thanks to their promise of longer driving ranges and enhanced [safety](#). However, these advantages have [not yet been demonstrated](#) in real-world applications. The term “solid-state batteries” covers a [wide range](#) of technologies, all of which use a solid electrolyte,<sup>25</sup> whereas lithium-ion batteries use a liquid solution of (flammable) organic solvents and a lithium salt as electrolyte.

[Semi-SSBs](#) are already commercial and use a solid polymer as electrolyte, which must operate at elevated temperatures (around [60-90°C](#)), at which the polymer transitions into a soft, rubber-like phase. [Almost-SSB](#) and [all-SSB](#) designs both operate with solid electrolyte that is maintained in a mechanically rigid state during operation. In the case of almost-SSBs, small volumes of liquid electrolytes are added on the cathode electrode to increase its conductivity. The most frequently mentioned advantages of SSBs – such as enhanced safety – come from almost- or all-SSB designs, which are currently at the prototype stage.

While all-SSB [cells](#) are already being produced at small scale for testing purposes, their manufacturing remains more complex and costly than that of lithium-ion cells, and integrating them into EV battery packs is complicated by stricter mechanical requirements, including the need to apply higher pressure to operate the battery. Among the most [advanced](#) are Japanese manufacturer Toyota – which tested a first [prototype](#) in 2021 and has [announced](#) plans to launch its first all-solid-state battery-powered vehicle by 2028 – and the Chinese firm BYD, which [plans](#) to sell its first EV using all-SSB from 2027 and to begin mass production from 2030. Korea’s [Samsung](#) has set similar timelines for all-SSB production. Developments are also continuing in the United States. QuantumScape [tested](#) its SSB in a motorcycle in 2025, while Factorial Energy [announced plans](#) to list on public markets after reporting a real-world test of well over 1 000 kilometres of range.

The early costs of SSBs are likely to be [high](#), reflecting immature manufacturing processes and supply chains. Premium markets – where customers value additional range and performance – could support early adoption, providing margins for manufacturers to navigate scale-up challenges and work towards lower production costs. Emerging markets, like robotic devices including [humanoid robots](#), could prove an important early source of demand and revenue for SSB producers. Nevertheless, this implies that it will take time for SSBs to make a dent in the EV mass market, and they are expected to remain limited to premium segments until the first half of the 2030s.

---

<sup>25</sup> Lithium-ion and solid-state batteries are composed of four main constituents – the cathode, anode, electrolyte and separator. The cathode and anode (which are also referred to as positive and negative electrodes) store lithium ions, the electrolyte enables the movement of lithium-ion between the electrodes (cathode and anode) during battery (dis)charging, and the separator prevents the electrodes from entering into direct contact, avoiding electrical short-circuits. In lithium-ion batteries, the electrolyte is liquid, whereas in solid-state batteries it is solid and performs the dual function of electrolyte and separator.

Q Are electric cars a fire risk?

As electric vehicle (EV) uptake accelerates, questions about battery safety – particularly fire risks – are receiving increasing public attention. Importantly, EV fires differ from those of internal combustion engine vehicles (ICEVs). While ICEV fires can be suppressed by cutting off the oxygen supply using typical fire extinguisher technologies, this is often not possible for EV batteries. Mechanical damage – such as that caused by a collision – can lead to short circuits and rapid increases in battery temperature. This can trigger thermal runaway, a self-accelerating reaction producing heat, flammable gases and oxygen. Because the battery provides both fuel and oxygen, fire extinction is considerably more challenging. In addition, if the battery is not fully consumed during the initial fire, it may also reignite hours or even days later.

Lithium-ion batteries are less likely to ignite when discharged, such as during shipment, than when charged, but they still retain enough energy to pose fire risks in the case of serious manufacturing defects – a challenge for large EV carriers, as well as for recyclers and waste handling facilities. Some sodium-ion battery chemistries have been reported to reach a near-zero energy state, which could reduce fire risks.

**FIRE RISK**



**FIRE SUPPRESSION**

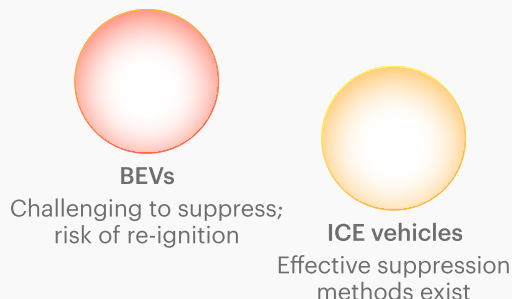

Despite these challenges, evidence indicates that EVs are less prone to fires than ICEVs. In Norway – the country with the world’s highest share of electric cars (over 35% of stock) – petrol and diesel cars were reported to catch fire four to five times more often than battery electric vehicles (BEVs) in 2023. In Sweden (over 15% of stock), only 0.01% of BEVs experienced fire incidents in 2024, over five times less than the average across all powertrains. Even larger differences have been highlighted by EV FireSafe, a private company funded by Australia’s Department of Defence, and the US-based National Fire Protection Association.

Data on EV fire rates remain limited, and comparisons are complicated by the fact that EVs are, on average, much newer than ICEVs. Nonetheless, the evidence available today indicates that BEVs are significantly less likely to catch fire than conventional cars. Battery safety and technologies have also improved markedly in recent years and continue to advance. For example, the latest EV batteries are reported to be able to withstand thermal-runaway events and remain operational for over one hour without igniting or exploding – providing sufficient time to move a vehicle to a secure location if an incident occurs. Similar safety characteristics will be mandated in China starting from July 2026 for new models, while previously approved vehicles will have until July 2027 to adapt.

# Chapter 6. Trends in electric vehicle charging

## Light-duty electric vehicle charger deployment

### Most electric car owners charge at home

Globally, the number of private<sup>26</sup> light-duty vehicle (LDV) charging points is estimated to have reached more than 43 million in 2025, supporting an electric LDV stock of around 76 million. About one-third of the private charging points worldwide are in the People's Republic of China (hereafter, "China"), one-third in Europe, and one in six in the United States.

Home charging – whether in a driveway, garage or other dedicated parking space – is currently the preferred way to charge an electric car for those with the ability to do so, due to its relative affordability and convenience. This is expected to remain the case in the coming years.

Access to home charging can vary, however, and is generally higher for electric vehicle (EV) owners living in houses rather than multi-unit residences. For example, in Norway, where a [large share](#) (64%) of the population lives in detached or semi-detached houses, around [90%](#) of EV owners can charge at home. In China, on the other hand, only [7%](#) of residents live in single-family houses, with the majority living in apartments. According to a [2025 survey](#), only around 50% of EV owners in China have home chargers, though another third have access to shared residential chargers (such as those in an apartment complex parking lots).

---

<sup>26</sup> Private charging refers to charging points that are located on private property and for which access is restricted (i.e. they are not publicly accessible). It does not include so called semi-public charging points, which are located on private property but accessible to the public. Private charging most commonly refers to residential charging or workplace charging.

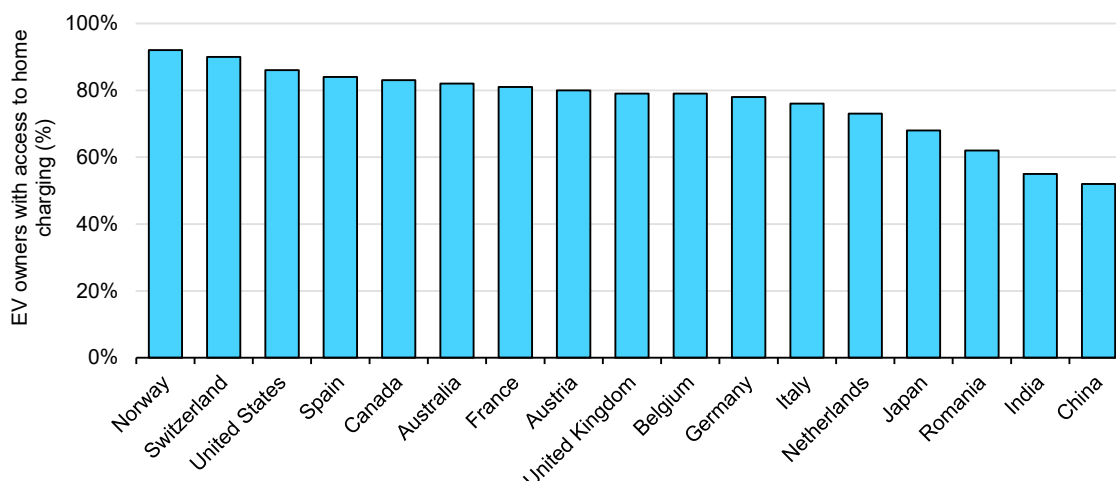
**Figure 6.1. Share of electric car owners with access to home charging, 2024**

IEA. CC BY 4.0.

Note: EV owners with access to home charging excludes shared residential chargers.

Sources: IEA analysis based on: ChargeLab, eMobility Power, McKinsey, *Mobilität in Deutschland 2023*, Mobility Portal, Norwegian EV Association, [Roland Berger](#), [RVO](#), [Government of Canada](#), [Zapmap](#).

In recognition of the importance of access to home charging, policy measures in place in many countries around the world include specific building regulations or codes. For example, in 2024 the European Union [revised](#) the Energy Performance of Buildings Directive to require new or renovated buildings to include pre-cabling for EV charging. This makes it easier for residents to install home chargers, while avoiding the future need for costly retrofits. Kenya's 2024 [National Building Code](#) mandates 5% of parking spaces in all new buildings be equipped for EV charging. India's Model Building Bye-Laws ([MBBL](#)) were amended in 2019 to include dedicated provisions for EV charging: charging infrastructure should be planned to cover 20% of parking capacity for all vehicles (including 2Ws). In Brazil, [several proposals](#) aim to support private charger installation in new buildings, including apartments. Actions are also being taken at the city level: a [2026 São Paulo law](#) guarantees that owners of condominiums have the right to install charging infrastructure in their private parking spaces.

Beyond building codes, some governments provide subsidies to install home and other private chargers. In Europe, more than [ten](#) countries offer subsidies for at-home charging. For example, in the United Kingdom, residents in flats or rentals with off-street parking and an eligible EV can receive [grant funding](#) of up to GBP 500 per household. Elsewhere, countries including Canada, New Zealand and the United States also provide support for chargers and installation through various national and regional funding programmes. However, the US [tax credit](#), covering 30% of the cost of purchase and installation of EV charging equipment up to USD 1 000 for low-income or non-urban communities, is set to expire on 30 June 2026.

## BEVs charged at home result in significant cost savings compared to driving a conventional ICE car

As electric cars are more energy efficient than internal combustion engine (ICE) cars (on average, a typical battery electric vehicle [BEV] uses around 70% less energy per kilometre than a gasoline ICEV of a similar size), driving a BEV results in cost savings, especially when charged at home. The running cost savings vary by region, according to energy price differentials, average vehicle size and average mileage. Energy price fluctuations can impact the economic proposition of BEVs, but ever since 2020, when compared to a gasoline car, refuelling electric cars has generally resulted in annual running cost savings of between USD 550 and USD 1 000 across major BEV markets, although the United States did see even higher savings from 2022-24.

In China, the average annual operating costs for a gasoline ICE car increased from USD 660 in 2020 to nearly USD 900 in 2022. Prices then declined to just over USD 700 in 2025, as gasoline prices fell. Nonetheless, annual operating costs for BEVs remain substantially cheaper when considering residential electricity rates, ranging from around USD 100 to USD 550 over the same period. As a result, the annual average running cost savings of battery electric cars in China have ranged from over USD 550 to nearly USD 800 this decade.<sup>27</sup>

**Figure 6.2. Annual energy prices and running cost savings of a battery electric car in selected markets, 2020-2025**

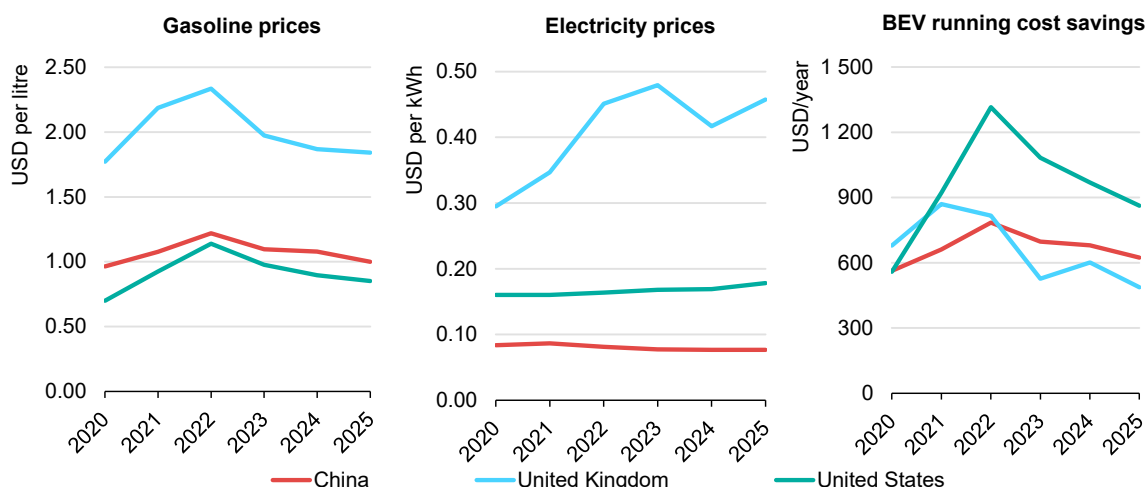

IEA. CC BY 4.0.

Notes: BEV = battery electric vehicle. Gasoline prices include federal taxes. Electricity prices refer to residential rates. Running cost savings represent the annual energy cost savings associated with the sales-weighted average battery electric car sold in each year, charged at home, compared to the sales-weighted average gasoline internal combustion engine car. For further details on the methodology, see [Annex E](#).

Sources: IEA analysis based on sources and assumptions listed in [Annex E](#) of this report and IEA's [Energy Prices](#).

<sup>27</sup> Average residential electricity prices are used in this assessment. Depending on the electricity provider, there may be additional savings with time-of-use electricity rates, enabling users to benefit from lower off-peak rates.

In the United Kingdom, average annual operating costs for ICE cars fluctuated between USD 1 200 – USD 1 700 between 2020 and 2025, while running costs for BEVs increased over 80% from just over USD 550 in 2020 to more than USD 1 000 in 2025, as electricity prices increased. This cut the running cost savings associated with a battery electric car compared to an ICE car from more than USD 650 in 2020 to nearly USD 500 in 2025. Unlike in China, where battery electric cars are, on average, cheaper to buy than gasoline ICE cars, in the United Kingdom battery electric cars are priced USD 13 000 higher on average, meaning that the payback period for the investment is still a barrier to adoption.

In the United States, annual ICE car operating costs have increased from around USD 1 000 in 2020 to USD 1 400 in 2025. At the same time, the cost of running a BEV has also increased from just below USD 450 in 2020 to nearly USD 600 in 2025, as average residential electricity prices increased by more than 50%. Despite the increases in running costs for BEVs, net savings increased by over 50% during this period, but ICE running costs increased more rapidly. As a result, in 2025, battery electric cars in the United States offered about USD 860 per year in running cost savings compared to gasoline ICE cars.

Home charging has consistently offered running cost savings compared to ICE cars in the major EV markets. However, the mark-up for public fast charging can change the picture. Electricity prices associated with public slow charging can be up to 150% higher than residential electricity tariffs, and public fast charging can be up to 240% higher than residential prices. As a result, exclusively using public fast charging for a battery electric car would result in higher running costs than a gasoline ICE car. [Survey data](#) indicates that worldwide, EV owners charge privately (at home or a workplace) almost 75% of the time, and charge at public fast chargers only 10% of the time, meaning that, on average, BEV owners are saving on running costs based on historic energy prices.

### **Box 6.1 Electric vehicle affordability in a high oil price environment**

Electric cars have lower running costs than ICE vehicles in most cases, mainly due to their higher efficiency. The recent oil price increase resulting from the closure of the Strait of Hormuz has translated into higher prices at the fuel pump as well as higher electricity prices in some instances.

Using the latest retail fuel price data for April 2026 and assuming that cars are charged at home, we estimate that the savings of running a battery electric car compared to a gasoline one have increased between 20% and 45% in most countries. For example, in the United States, running cost savings increased from around USD 900 per year to USD 1 300 per year. The degree to which retail fuel

prices rise with crude oil prices varies across regions due to differences in fuel taxation. In many European countries, taxes and levies account for a large share of the fixed fuel cost so prices rise more slowly, while in the United States lower taxation means that the correlation is stronger. In some countries, fuel taxation has been reduced in response to the oil price increase, resulting in a reduction in the savings offered by electric cars compared to in 2025.

### Yearly energy cost difference from running a new battery electric vehicle compared to a gasoline vehicle, 2025 and April 2026

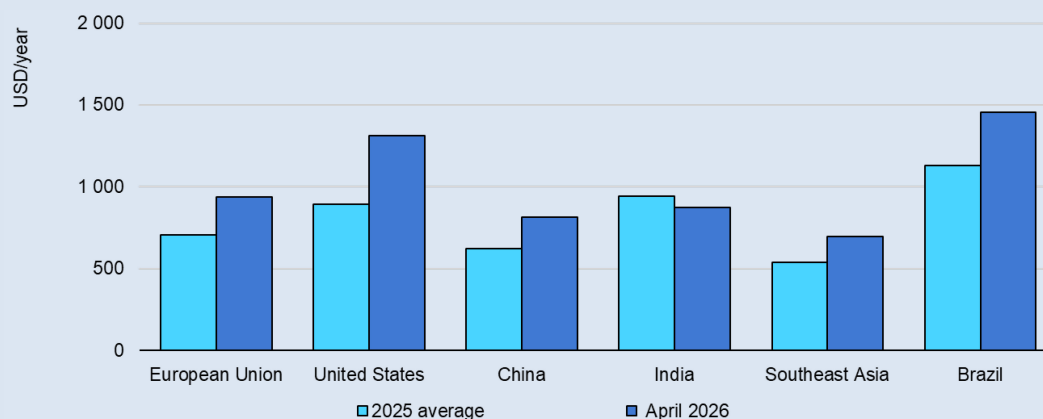

IEA. CC BY 4.0.

Notes: Average brent price in 2025 was 68 USD/bbl; in April 2026 it was 100 USD/bbl on average.

Sources: IEA analysis based on data from [GlobalPetrolPrices](#).

Nevertheless, in most countries analysed, the yearly savings are significantly higher than in 2025 due to the high oil price environment, but the payback period is, on average, only around 20% lower (assuming high prices persist). For countries where electric cars have already reached price parity, the additional savings can strengthen the affordability proposition of electric cars. The savings offered by electric cars are directly proportional to mileage, therefore for drivers that drive more than average, the savings are more noticeable. A driver travelling 30 000 km per year in the European Union could save USD 2 800 per year with April 2026 prices – or USD 700 more than in 2025. Over time, electricity prices may also rise if natural gas prices increase, partially offsetting these gains. Oil prices around USD 100/bbl (per barrel) therefore strengthen the value proposition of EVs, but they do not fundamentally alter their overall cost-competitiveness.

Q How important is access to home charging for electric car adoption?

**ANNUAL CAR OPERATING COSTS BY POWERTRAIN, CHARGING PROFILE, AND REGION, 2025, IN USD**

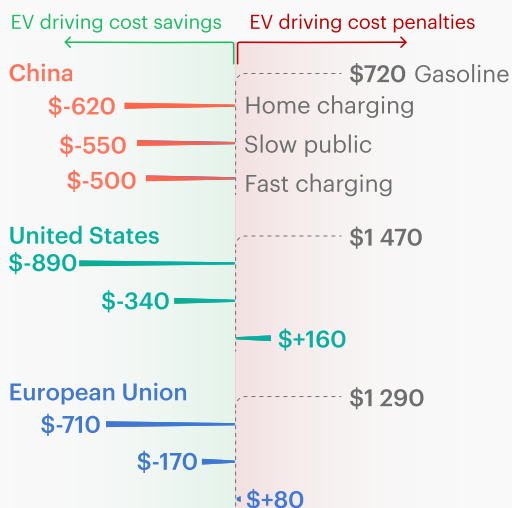

Potential electric car buyers have a number of considerations to weigh when making a purchasing decision, and the convenience and cost of charging an EV are chief among them. For those able to charge at home, these aspects are less of a concern. But for potential buyers who do not have a private parking space or cannot install a charger at their residence, EV charging prospects become more expensive – electricity prices of public slow charging can be up to 150% higher than residential electricity tariffs. This can reduce the economic incentive to switch to an electric car, although they generally remain cheaper to run than gasoline powered alternatives.

Several solutions already exist for car owners without access to home charging. In this regard, China offers a useful example: despite an EV sales share above 50% and the world’s largest electric car stock, only slightly more than half of households have access to home charging.

Most driving patterns do not require daily charging, with an average daily driving distance of 30-70 km for private cars. Even daily taxi ranges, typically around 150-250 km, are roughly half of the average on-road battery electric car range in mixed (city and highways) driving conditions.

Workplace charging is growing, offering a convenient option during workdays. Public overnight and curb side charging infrastructures are also expanding, as well as semi-private chargers, such as in parking lots. With the growing public ultra-fast charging network, compatible vehicles can recharge sufficiently in a 20-minute session to provide enough energy for several days of commuting. These chargers are increasingly available not only along highways, but also at fuel stations, supermarkets, and other retail locations, making them easy to integrate into routine activities. However, fast charging is significantly more expensive, and can completely erode the operational cost benefits of electric cars.

Governments can help narrow the gap between residential electricity prices and public charging tariffs. For example, India and Indonesia regulate the electricity price applied to public EV charging. Alternative approaches expanding access to affordable charging also require dedicated regulations. Curb side home-charging – where residents without private parking use their own residential electricity to charge an EV parked on the street via a charging cord – and peer-to-peer home-charger sharing, where residents rent out their private chargers, are two emerging options.

To provide equitable access to affordable charging for people who cannot charge at home, the rollout of public chargers near multi-family housing, workplace charging, and other low-cost charging options should be prioritised. Governments can support this by financing charger deployment in underserved areas and by establishing the regulatory frameworks needed to enable new charging models.

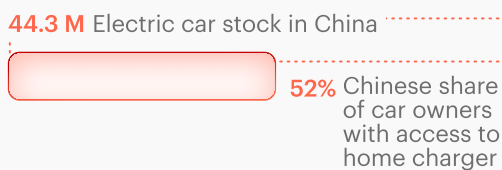

## Public charging infrastructure rollout further accelerated in 2025, reaching more than 7 million charging points

The stock of public charging points increased more than 33% in 2025

While access to home and other private charging is important, the availability and accessibility of public charging is key to enabling wider access to EVs. In 2025, nearly 1.8 million public charging points were added to the global stock, representing an increase of more than 33% compared to the previous year, in line with the growth of the electric LDV fleet. The total stock of public charging points worldwide reached more than 7 million at the end of 2025.

There are several metrics that can help gauge whether the build-out of public charging infrastructure is keeping up with the deployment of electric LDVs. One is the number of public charging points compared to the number of electric LDVs on the road: in 2025, there were around 11 electric LDVs worldwide per public charging point, similar to the value in 2024. In addition, given that faster, more powerful chargers can meet the needs of more vehicles in a set timeframe, the public charging capacity per electric LDV is another key metric to gauge the sufficiency of the network. On average, there was 4.5 kilowatts (kW) of public charging capacity per electric LDV worldwide at the end of 2025.

**Figure 6.3. Global stock of public charging points by speed and region, 2020-2025**

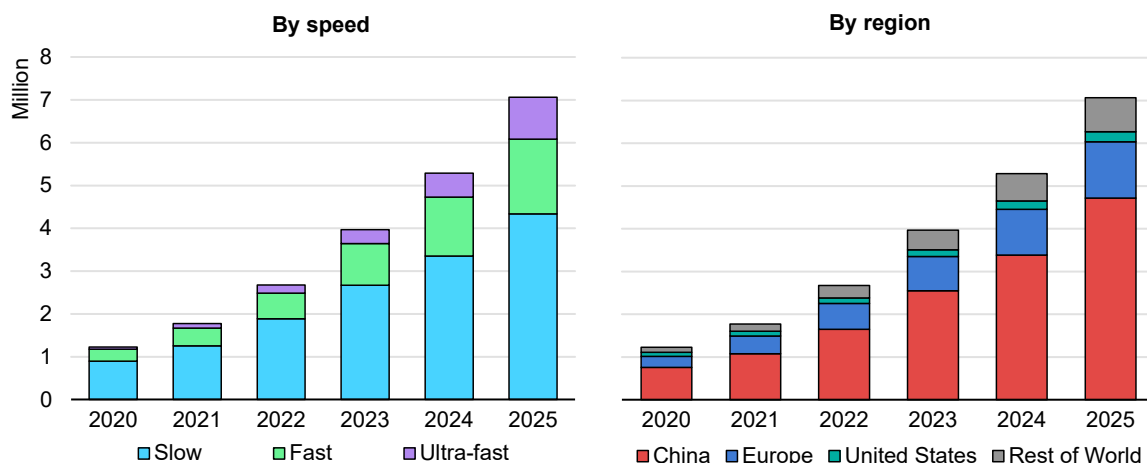

IEA. CC BY 4.0.

Note: Chargers less than or equal to 22 kW are classified as slow; chargers greater than 22 kW and up to 150 kW as fast; and 150 kW and above as ultra-fast.

Sources: IEA analysis based on EV Volumes, [EAFO](#) and BNEF.

The average speed of public charging points increased in 2025, as the share of public fast and ultra-fast charging points increased faster than slow public charging points.<sup>28</sup>

**China** continues to hold the largest stock of public charging infrastructure, representing more than 65% of public charging points globally at the end of 2025. China's public charging infrastructure grew from nearly 3.4 million charge points at the end of 2024 to over 4.7 million at the end of 2025, accounting for over 75% of the global growth. As of the end of 2025, there were ten electric LDVs per public charging point in China. The number of fast and ultra-fast chargers grew 40% from 1.5 million in 2024 to 2.2 million in 2025. As a result, the estimated average charging speed of public charging points was over 55 kW, higher than the global average of 50 kW, and resulting in nearly 6 kW of public charging capacity per electric LDV. China has also announced [a plan](#) to further expand the national charging network by more than 60% compared to 2025 by the end of 2027.

In **Europe**, the number of public charging points increased by about 20% in 2025. Within the European Union, five countries saw their charging networks grow by more than 50%: Denmark, Estonia, Latvia, Lithuania, and Romania. This was driven in part by projects such as the [EXPAND-E project](#), which provided over EUR 70 million (USD 75 million) in funding for LDV charging projects across 23 EU member states. Meanwhile, in the United Kingdom, the number of public charging points increased more than 30% to about 116 000. The Netherlands had the most public charging points in Europe at the end of 2025, with 210 000, up from 184 000 at the end of 2024. Germany and France followed closely, with 196 000 and 185 000 charging points, respectively, at the end of 2025. On average, the European Union has 11 EVs per public charging point, close to the global average. The estimated public charging capacity was around 3 kW per electric LDV at the end of 2025, lower than the global average. Nonetheless, the rollout of ultra-fast chargers has been supported by large-scale infrastructure policies, such as the Alternative Fuelling Infrastructure Regulation (AFIR), which mandates the installation of charging stations for cars and vans of at least 150 kW every 60 km along major highways in the European Union, where the number of ultra-fast charging points has increased 30% from 2024 to 2025.

The **United States** saw a record number of public charging points added in 2025, with 20% more added than in the previous year. However, the public charging stock remains only a small share of the global total: 3% of global public charging points compared to 10% of global electric LDV stock. The total number of fast and ultra-fast charging points in the United States grew 30% to nearly 70 000 in 2025, while the number of slow charging points increased to reach over 160 000 in 2025. This growth was in spite of a pause in the [National EV Infrastructure \(NEVI\) Funding](#)

---

<sup>28</sup> Chargers with power ratings less than or equal to 22 kW are classified as slow, chargers with power ratings greater than 22 kW and up to 150 kW as fast, and chargers with power ratings 150 kW and above as ultra-fast.

[Program](#), one of the major government funding programmes for public fast charging points deployment along highway corridors, for which obligations were paused from February 2025 to January 2026. In August 2025, the US Federal Highway Administration (FHWA) released new [interim guidance](#) for implementing state NEVI programmes, allowing states to start submitting their 2026 plans. As of April 2026, around 550 NEVI-funded fast charging points were [operational](#) across 19 states, representing only a small share of public charging points. However, another 1 000 charging points have already been fully awarded funding from fiscal year (FY) 2022-25 budget allocations, and 42 states have had FY 2026 plans approved. By the end of 2025, the United States had 33 electric LDVs per public charging point, a value that has continued growing steadily this decade, from less than 20 electric LDVs per charging point in 2020. The capacity per EV is also lower than the other major EV markets at just over 1.5 kW per electric LDV, though the United States does have greater access to home charging.

**Figure 6.4. Number of electric light-duty vehicles per public charging point and kilowatt per electric light-duty vehicle, 2025**

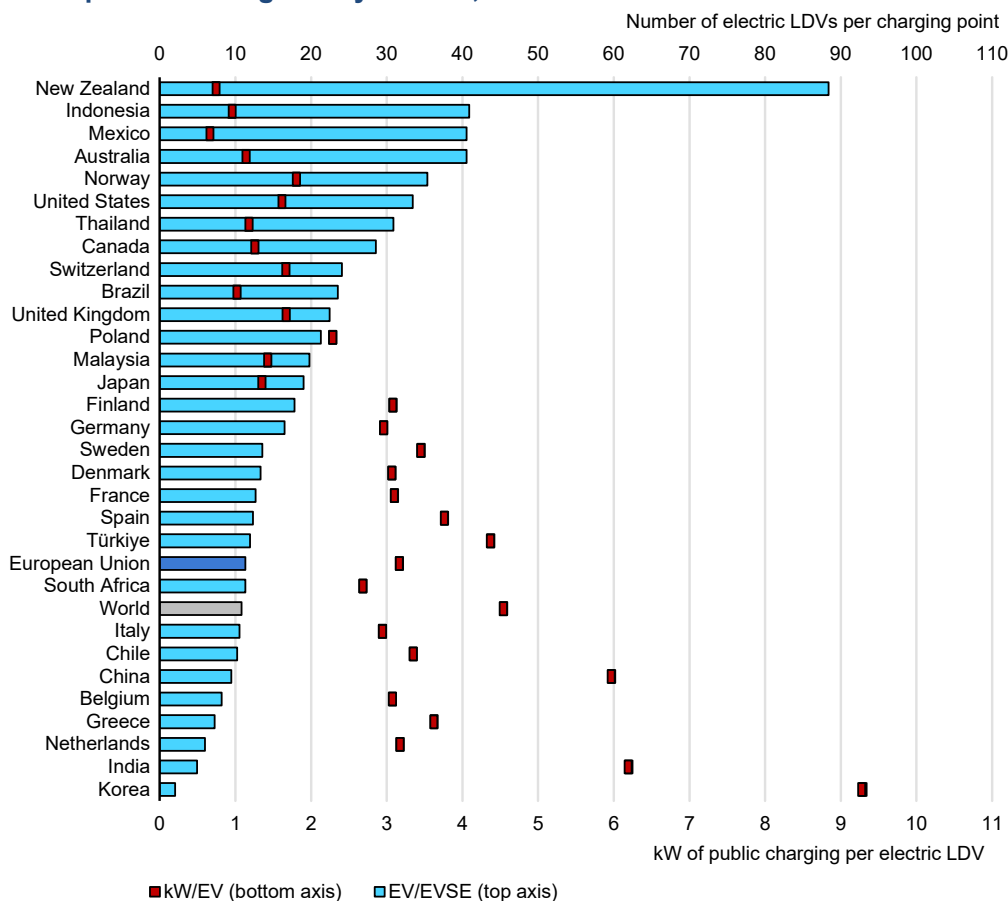

IEA. CC BY 4.0

Notes: EV = electric vehicle; EVSE = electric vehicle supply equipment (charging point); LDV = light-duty vehicle. Chargers with a power rating less than or equal to 22 kW are classified as slow, those rated greater than 22 kW and up to 150 kW as fast, and those rated as 150 kW and above as ultra-fast. For the calculation of average kW per EV, the average speed of a slow charger is 15 kW, a fast charger is 50 kW, an ultra-fast charger type 1 is 150 kW and an ultra-fast charger type 2 is 350 kW, and a megawatt charger is 1 MW. EVs refer to electric light-duty vehicles only. Official national statistics, which rely on more granular data, might differ from these values.

Sources: IEA analysis based on country submissions, [EV Volumes](#), [EAFO](#), [US AFDC](#) and BNEF.

Latin America has shown promising growth as policies take shape. In **Brazil**, public charging points increased by close to 35% in 2025. This growth, however, was lower than the increase in electric LDV stock, which rose by over 80%, increasing the number of electric LDVs per charging point from 17 to 24. Most of the public charging point stock in Brazil is slow, but the share of fast chargers increased significantly in 2025, to reach more than 20% of the stock. Still, the country has about 1 kW of public charging available per electric LDV, though Brazil also has a significantly higher share of plug-in hybrid electric vehicles (PHEVs) in the electric LDV stock (55%) than the global average. Brazil also recently introduced a [bill](#) that would provide tax incentives for public or shared EV chargers.

Other Latin American countries are also providing government support for public EV charging. In **Argentina**, simplified registration procedures are expected to further aid EV charging rollout, and the city of [Buenos Aires](#) is planning to install 400 additional charging stations by 2027. **Chile**'s public charging grew by 20% to just over 2 000 charging points, although most of these are in Santiago. **Mexico** has also introduced [new provisions](#) for charging infrastructure aimed at standardising grid connections, improving price transparency for users and creating clearer pathways for gas stations to integrate EV charging into their refuelling networks. The country saw a rapid uptake of EVs in 2025, most of which were PHEVs, with the electric LDV stock more than doubling in a year. This pace was not matched by public charging deployment, which increased by less than 25% to reach 4 000 charging points in 2025. As a result, the number of electric LDVs per public charging point in Mexico more than doubled.

**India** saw public charging point numbers increase by 15% in 2025, reaching 88 000 <sup>29</sup> The latest round of [PM E-DRIVE](#) funding for 2024-26 included INR 20 billion (Indian rupees) (USD 230 million) for public EV charging stations, targeting support for 22 100 EV fast chargers, however the scheme has been extended to [2028](#).

The rapid deployment of fast chargers in some Southeast Asian countries has been carried out in line with the rollout of electric cars. In **Malaysia**, public fast chargers grew by more than 70% year-on-year in 2025. Malaysia has several incentives to further increase deployment of public chargers, including the [Green Investment Tax Allowance](#), under which charging point operators can receive a tax exemption for 5 years if investment thresholds are met. In **Indonesia**, over 4 500 public chargers have been deployed by the state-owned power utility PLN, and the country's [first ultra-fast](#) charging station, developed in collaboration with

---

<sup>29</sup> As India [reports](#) only the total number of charging stations, this analysis converts stations to charging points by applying an assumption of three charging points per station for India.

two other partners, was unveiled at the start of 2026. **Thailand** currently hosts nearly 12 000 public chargers. Fast chargers gained momentum with an increase of 30%, making up 60% of the stock in 2025. Despite this progress, EV uptake outstrips charger rollout, with the number of EVs per public charger increasing from 19 to 30 EVs per EVSE from 2024 to 2025.

Elsewhere, **Korea** has seen a 10% increase in fast charging points (including ultra-fast), rising from 47 000 in 2024 to 51 000 in 2025. Korea also has the highest public charging capacity per EV of any country with over 9 kW of rated capacity available per electric LDV in 2025, and just over 2 EVs per public charging point.

### Deployment of ultra-fast chargers has accelerated, though only about 30% of battery electric cars today can benefit from them

The continued deployment of ultra-fast charging has increased the average speed of charging points worldwide by 15% in the past year, from just over 40 kW in 2024 to nearly 50 kW in 2025. At the same time, the global public charging capacity available per electric LDV increased from 4 kW to 4.5 kW between 2024 and 2025.

Behind the trend of increasing kW per charging point lies the increasing speeds of ultra-fast chargers themselves, with next-generation ultra-fast chargers providing power above 250 kW. For vehicles that can take advantage of ultra-fast charging, charging a car for 15 minutes at a 150 kW charger can provide almost 180 km of driving range<sup>30</sup> in mixed (city and highway) driving conditions. Today, only a few high-end electric cars can charge at this speed, but charging point operators such as Fastned, BYD, Iberdrola, Charge+ and BP Pulse are already deploying these stations in anticipation of future demand. In 2025, there were roughly 160 battery electric car models known to be available that can charge at speeds higher than 150 kW; for charging speeds greater than 250 kW the number of models decreases further to 50 (out of 670 battery electric car models), or only 4% of all electric cars sold since 2010 (see [Chapter 8](#) on ultra-fast charging).

At the same time, innovation in batteries and charging points continues to break charging speed records, with [BYD](#) “flash” charging points (up to 1.5 MW), unveiled in early 2026, being a prominent example aimed at LDVs, with other megawatt charging solutions targeting HDVs. Besides model availability, temperature can also limit ultra-fast charging (see Box 6.2).

---

<sup>30</sup> Assuming that charging starts at 10% of battery state of charge, an on-road vehicle range of 400 km in mixed (highway and city) driving conditions, and with a battery pack of about 67 kWh. See [Annex C](#) for more details.

**Figure 6.5. Number of public light-duty vehicle charging points and power availability across selected regions and countries, 2020-2025**

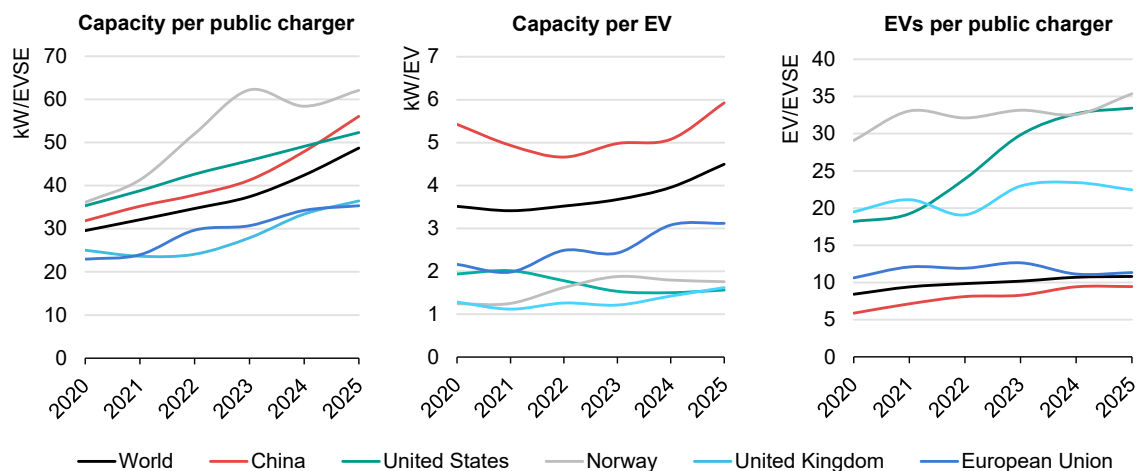

IEA. CC BY 4.0.

Notes: EV = electric vehicle; EVSE = EV supply equipment. Chargers with a power rating less than or equal to 22 kW are classified as slow, those rated greater than 22 kW and up to 150 kW as fast, and those rated as 150 kW and above as ultra-fast. For the calculation of average kW per EV, the average speed of a slow charger is 15 kW, a fast charger is 50 kW, an ultra-fast charger type 1 is 150 kW and an ultra-fast charger type 2 is 350 kW, and a megawatt charger is 1 MW. EVs refer to electric light-duty vehicles only. Official national statistics, which rely on more granular data, might differ from these values.

Sources: IEA analysis based on [AFDC](#), [EV Volumes](#), [EAFO](#), [United Kingdom Department for Transport](#) and country submissions.

### Box 6.2 Insights based on data collected on charging stations in Germany

The transition to electric cars benefits greatly from available data on the location, utilisation and performance of public chargers. With more data, researchers, investors and drivers can better understand how the public charging system is currently being used – and where it can be improved.

Although these datasets are not readily available today, several examples exist. The [NOW GmbH](#) (Nationale Leitstelle Ladeinfrastruktur), Germany's National Coordination Office for Charging Infrastructure, collects data on federally and state-subsidised charging points. Today, there are over 32 000 charging points included in their database. The dataset currently covers the years 2018 to 2025 and is updated every six months. It includes details on each charging session, such as start and stop times, maximum charging power and total energy delivered, as well as the station location type.

Time-based utilisation – which indicates the proportion of time a charging point is occupied and delivering power relative to the total time it is available – increased steadily from 1.5% in 2018 to almost 9% in 2022, and has stabilised at around 8%

since then.\* However, there is a wide variability: while most charging points operate below this level, the busiest 5% reach utilisation rates consistently over 25%.

### Average rated power and utilisation of chargers by location and speed, 2024

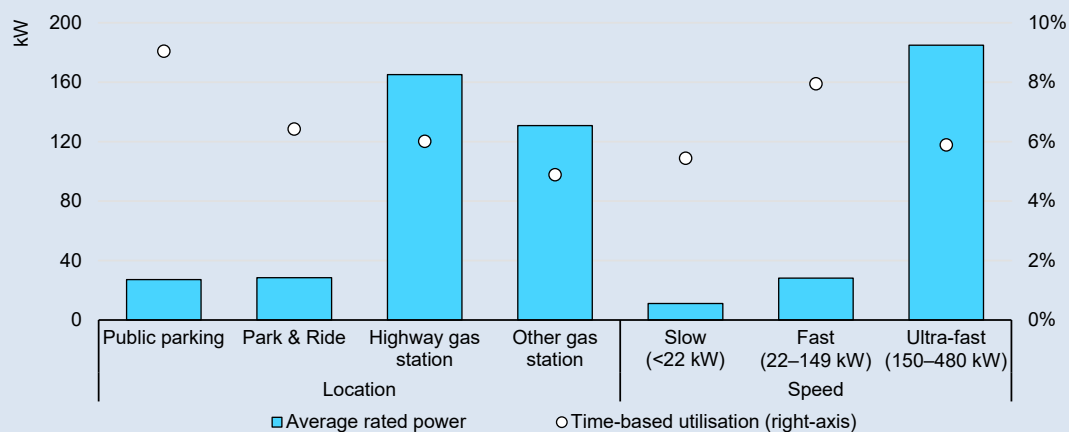

IEA. CC BY 4.0.

Source: IEA analysis based on data from [NOW GmbH](#).

Besides an increasing time-based utilisation of the charging network, the data shows that the ratio of delivered power to rated power has also increased for most charging point categories.\*\* In 2018, the average delivered-to-rated-power ratio was around 30% for all chargers, while in 2024 the ratio increased to nearly 35%. This trend reflects that vehicles are increasingly capable of charging at higher speeds and frequently approaching the charger's maximum rated power during certain phases of the charging session, particularly at lower states of charge ([Chapter 8](#)).

However, the extent to which delivered power approaches rated power varies depending on charger speed. For ultra-fast chargers with rated power above 350 kW, the ratio declined from 20% to 17%, which is probably because the rated power of these chargers is rising faster than most vehicles' charging capabilities, meaning cars often cannot utilise the highest charging speeds available. However, a low ratio is also seen with slow chargers, where delivered power is just 45% of rated power on average. This is likely to indicate reduced power at higher states of charge to protect the battery. This is especially relevant if vehicles remain connected without actively charging, which is likely to be more common with slow rather than fast chargers.

Apart from limitations specifically related to the car, the outside [temperature](#) has a large impact on the maximum speed at which a car can charge. At temperatures below 0°C, the ratio drops by 8% for slow chargers and 7% for ultra-fast chargers, compared to higher temperatures. Lower energy throughput at cold temperatures is accompanied by longer charging times. This is especially noticeable for ultra-fast charging, for which charging times increase by about 20% when charging at between -5 and 0°C compared with charging at 20 to 25°C.

### Impact of temperature on the delivered power and change in charging time across temperatures ranges

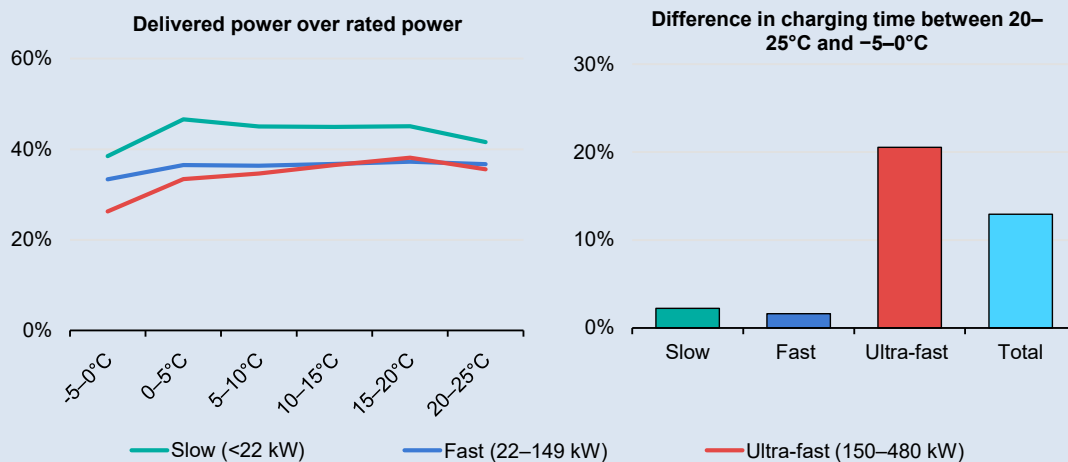

IEA. CC BY 4.0.

\* Time-based utilisation indicates the proportion of time a charging point is occupied and delivering power, regardless of the energy delivered. In contrast, energy-based utilisation reflects the proportion of the charger's total energy capacity used.

\*\* Rated power is the maximum power a charging point is designed to deliver under ideal conditions. Delivered power is the actual power supplied to the vehicle during a charging session, which can be lower due to battery limitations, cable losses, or environmental factors.

Sources: IEA analysis based on data from [NOW GmbH](#) and [DWD](#).

## Heavy-duty vehicle charger deployment

### The rollout of public HDV chargers is speeding up

The uptake of electric trucks has recently accelerated in China and, to a lesser extent, in Europe (see [Chapter 4](#)). Growth is focused on applications in which distances are shorter and trucks can rely on depot charging. Today, the average range of a battery electric truck is 300 km (Figure 4.4), which is below the ranges needed for long-haul applications. The rollout of public chargers suitable for medium- and heavy-duty vehicles (HDVs) is therefore becoming crucial to enabling the deployment of electric trucks for long-distance applications.

Electric trucks can use either chargers specifically dedicated to HDVs, using an HDV-specific connector (such as the Megawatt Charging Standard or ChaoJi) or chargers that primarily serve LDVs but can be accessed by trucks (i.e. site layout allows adequate manoeuvring and parking). However, in reality, only a small share of LDV chargers can be used by trucks: a recent [project](#) analysing heavy-duty chargers in Helsinki, Finland, identified only 25 locations out of a total 5 000 public charging points that were suitable for trucks.

Available data on the number of public HDV charging points is sparse, but efforts have been ongoing to improve data availability for this charger class. In 2025, the [European Alternative Fuel Observatory](#) (EAFO) released country-level details on the number of charging points for HDVs within the European Union. Furthermore, [eTrucker](#), a mobile application, has tracked where electric truck drivers can charge easily across Europe. In China, several charger operators publish details on their truck coverage, but deployment is not as closely monitored. In the United States and Canada, the [Alternative Fuel Data Centre](#) (AFDC) tracks deployment.

We estimate that in 2025, over 70 000 public charging points able to accommodate HDVs were available globally (of which 1 200 could be verified as being exclusively dedicated to trucks). With a total stock of more than half a million electric heavy-duty trucks, this would mean that each HDV-accessible charger would need to be shared with more than seven electric heavy-duty trucks on average globally.

**Figure 6.6. Electric heavy-duty vehicles per heavy-duty vehicle charging point in selected regions compared to stock share (left) and heavy-duty vehicle charging points and stations, 2025**

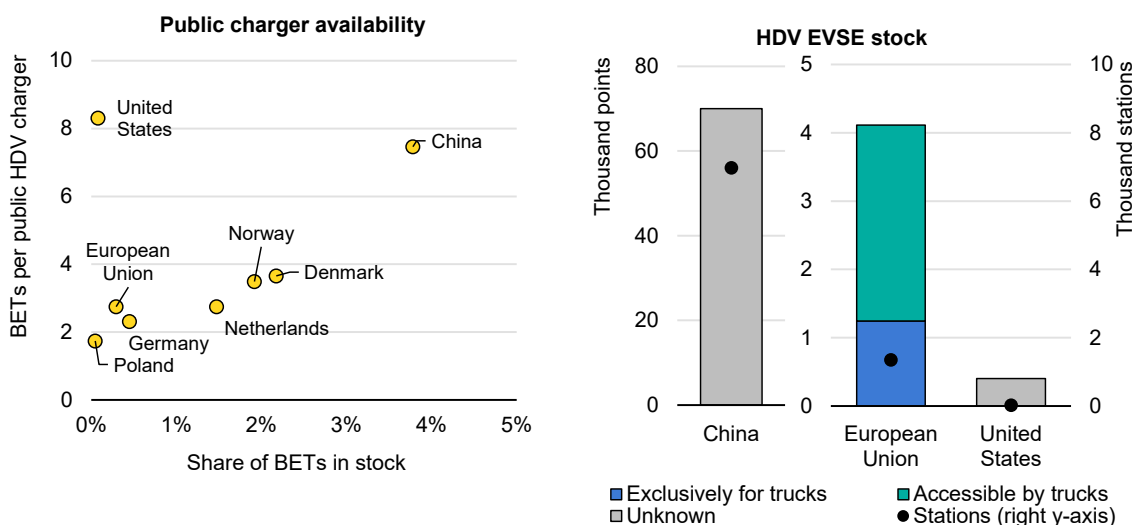

IEA. CC BY 4.0.

Notes: BET = battery electric heavy-duty truck; HDV = heavy-duty vehicle; EVSE = electric vehicle supply equipment. Charging points are individual outlets that allow simultaneous charging, and charging stations are locations that include one or more points. Both public chargers that are exclusively dedicated to HDVs and public passenger car chargers that can accommodate HDV fast charging are included. When the source does not specify the charger type, it is labelled “Unknown.” For chargers exclusively for HDVs, the higher value reported by either eTrucker or EAFO was used. For charging points accessible to both light- and heavy-duty vehicles, eTrucker data was used, and the average of stations and points was applied because one truck may block multiple spaces. These charging points do not include battery swapping stations.

Sources: IEA analysis based on [eTrucker](#) database, [EAFO](#), [Anengjenergy](#), [CPNN](#), [Calstart](#), [AFDC](#).

## China accelerates heavy-duty charging through integrated grid and corridor planning

By the end of 2025, China had deployed nearly 1 million electric trucks, which roughly equates to 3% of its truck fleet. Estimates on the number of public HDV charging stations in China vary between [5 000](#) and [9 000](#); by assuming approximately ten charging points per charging station, this would equate to roughly 70 000 HDV charging points. When considering public and private HDV-dedicated chargers, estimates approach nearly [140 000](#). [Research](#) on 2 700 truck stations show that roughly 1% of truck chargers are MW-scale, with the majority having charging speeds between 300-400 kW.

Emerging trends in the country include the integration of renewable energy, stationary storage and high-power HDV charging at dedicated hubs. For example, the [Huawei megawatt charging hub](#) which commenced operations in August 2025, combines 18 megawatt chargers (1.44 MW), with 1 MW of solar PV on the carport rooftop and a microgrid, so that it can operate independently from the main grid when needed. There are also ongoing efforts to ensure enough coverage on main freight corridors. In Yunnan, the [fast charging](#) corridor of 4 major routes (3 350 km) was finalised in 2025, with one station every 50 km, with an average of 110 kW per charging point. Furthermore, an [electric truck trial journey](#) that spanned 5 000 km was completed successfully, totalling nine charging stops.

Besides cross-country corridors, there has also been progress at [linking logistical nodes](#), with public chargers in specific industrial clusters ensuring that sufficient chargers are available at each node. For example, the Tangshan corridor connects ports, steel mills and petrochemical bases, and Yichang Petroleum in Hubei is targeting phosphate ore transportation lines and setting up points at the entrance to mining areas.

Currently there is no national policy that covers truck charging in detail. However, at the end of 2025 the government announced an [action plan](#) to double its charging capacity by 2027. This plan is primarily focused on LDVs, but its emphasis on expanding grid capacity, standardisation and interoperability may indirectly support the rollout of HDV charging solutions as well.

## Europe scales up HDV-charging infrastructure, backed by major funding commitments

After China, the European Union has shown the greatest progress in deploying public chargers suitable for trucks, with more than 4 000 available today. About 30% of these are exclusively available to trucks; these chargers are nearly all faster than 150 kW, and over two-thirds can charge at speeds between 350 kW and 1 MW. Today, over 40 chargers faster than 1 MW have been identified.

**Figure 6.7. Number of heavy-duty vehicle charging points and stations (left) and distribution of charging speed (right) in selected European countries, 2025**

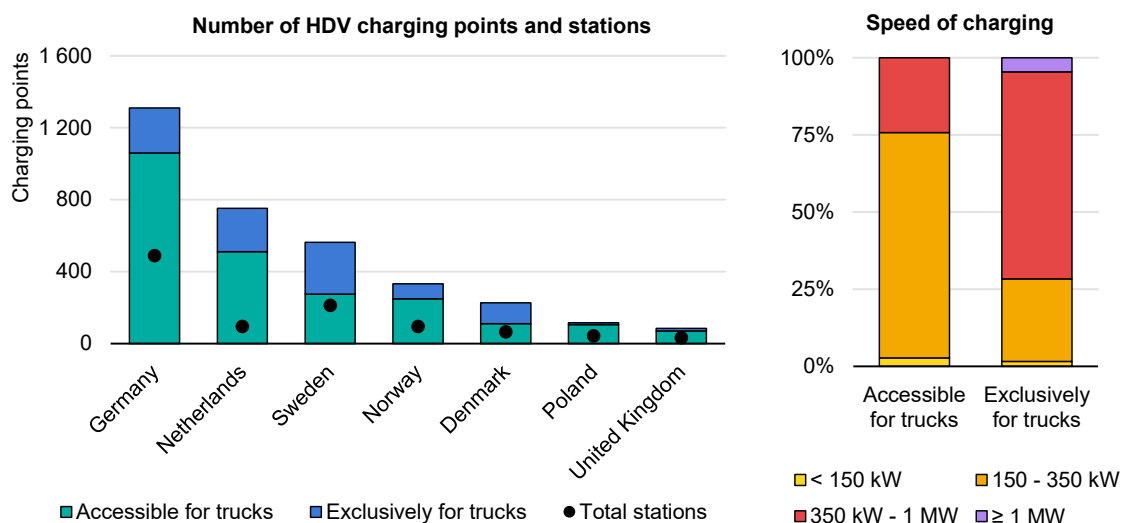

IEA. CC BY 4.0.

Notes: HDV = heavy-duty vehicle. Both public truck-dedicated chargers and public passenger-car chargers that can accommodate truck fast charging are included. For truck-exclusive chargers, the higher value reported by either eTrucker or EAFO was used. For chargers accessible to both light- and heavy-duty vehicles, eTrucker data was used, and the average of stations and points was applied because one truck may block multiple spaces.

Sources: IEA analysis based on [eTrucker](#) database, [EAFO](#) and country survey templates.

In 2025, the second phase of the Alternative Fuels Infrastructure Facility (AFIF) was finalised. The AFIF distributes EUR 1 billion (USD 1.1 billion) to support the AFIR objectives. In this second round, EUR 600 million (USD 650 million) was allocated to transport decarbonisation projects. Of the [70 selected projects](#), 19 projects in 11 member states include HDV chargers, totalling [2 000](#) new HDV charging points with rated capacities of at least 350 kW, and nearly 600 charging points with at least 1 MW. Deploying them all would increase the truck public charging stock by 60% compared to today, and would increase the number of MW chargers 14-fold.

**Germany** currently has one of the largest numbers of chargers dedicated to trucks. At the start of 2026, about [70 stations and 270 charging points](#) for trucks were available. As part of its “Power to Road” plan of 2024, [350 heavy-duty charging stations](#), totalling 2 400 ultra-fast and 1 800 MW charging points, were planned and had been tendered for. In December 2025, the European Commission approved the budget of [EUR 1.6 billion](#) (USD 1.7 billion) for these government-funded stations. The German government also released its [Masterplan Ladeinfrastruktur](#) (Charging Infrastructure Masterplan) 2030, detailing funding guidelines for depot chargers and grid connection for companies, and streamlining planning and permitting processes.

In the **Netherlands**, efforts are underway to develop a [HDV charging network](#). As part of a [research project](#), 6 charging hubs are being monitored on technical

design, spatial planning, grid integration, logistic process and business case development. To encourage companies or fleet owners to install more public HDV chargers, a [subsidy](#) to cover up to 20% of the costs was made available at the start of 2026, with a total budget of EUR 14.5 million (USD 15 million).

The country with the highest road freight transport in the European Union is **Poland**, accounting for about [20% of total tonne-km](#). In April 2025, the government announced several [funding programmes](#) to support the transition to EVs, one of which is dedicated to HDV charging, with an allocated budget of [PLN 2 billion](#) (Polish zlotys) (USD 550 million). Given that grid expansions will be crucial to the transition, the government allocated another [PLN 2 billion](#) (USD 540 million) to expand 50 energy supply points to power these HDV stations.

### Progress in the rest of the world is mixed

In other parts of the world, deployment is taking place at a smaller scale. In the **United States**, the number of public and semi-public chargers accessible to medium- and heavy-duty vehicles increased by over 30% to 400 charging points in 2025, a lower growth rate compared to 2024. Most of these chargers are [located](#) in California, which has also deployed the largest share of electric trucks. The number of chargers could soon increase, as nearly 1 000 HDV chargers are under development or pre-construction.

In **India**, [three electric truck charging stations](#) became operational in 2025, of which two were located at ports and one on the highway. Besides these truck-dedicated chargers, the first [10 high-speed chargers](#) were installed along two Indian highways, with speeds ranging from 120 kW to 400 kW. The latest round of [PM E-DRIVE](#) funding for 2024-26 (see above) aims to support 1 800 EV fast chargers for electric buses or trucks by March 2026. The [proposal guidelines](#) published at the end of 2024 also indicated priority highways for buses and trucks.

## Delays in depot charging can constrain electric HDV uptake

Depot charging is a crucial element of HDV electrification, particularly for urban bus fleets, which typically rely on overnight or opportunity charging at central depots. The successful deployment of electric buses therefore depends not only on vehicle availability but also on timely access to adequate charging infrastructure.

Planning depot charging for electric bus and truck fleets requires an integrated approach, combining route profiling, battery sizing, charging strategies and the number of chargers installed. Poorly optimised charging infrastructure can significantly increase peak power demand, raising costs and increasing grid

connection timelines. In some cases, shifting part of the charging load to daytime or off-peak periods can reduce maximum depot power demand by up to [60%](#).

Despite these optimisation options, grid connection delays remain a major bottleneck for electric bus deployment, especially for large depots with a high concentration of charging points. In urban areas, limited substation capacity, long permitting procedures and the need for network reinforcements can delay charging depots by several years, directly [slowing](#) fleet renewal plans.

Beyond grid constraints, existing bus depots often face physical and operational challenges when integrating charging infrastructure. Charging points, cabling and transformers require space that is not always readily available in existing depots, while bus operations typically need to be maintained throughout the year. This limits the ability to phase construction flexibly or temporarily reduce fleet size. In addition, misalignment between depot installation timelines and vehicle delivery schedules can further [delay](#) the entry into service of electric buses.

In several countries, governments have introduced schemes to support the development of depot charging. For instance, in the United Kingdom, the government launched the [Depot Charging Scheme](#) in 2025, offering grants covering up to 70% of the cost of installing charging infrastructure at fleet depots, or up to GBP 1 million (USD 1.3 million) per organisation. Similarly, in the Netherlands, the [SPRILA](#) scheme was available for private depot charging points in 2025, with a budget of EUR 87.5 million (USD 94 million).

## Alternative charging solutions

While plug-in cable-based charging is expected to remain the dominant solution in the foreseeable future, a number of alternative technologies to powering EVs are also being developed and deployed. Among these, battery swapping is the most widespread, followed by electric road systems.

### Battery swapping is already available for various vehicle types across several countries

#### Battery swapping combines fast charging and low strain on the power grid, but requires standards and investments

Battery swapping entails the replacement of a depleted EV battery with a fully charged unit at a dedicated swapping station, which are often highly automatised. The removal of the discharged battery and installation of a charged one typically takes as little as [3 minutes](#); for simpler systems used by two- and three-wheelers (2/3Ws), the process typically requires [less than 1 minute](#). This compares with several hours when using slow chargers and is broadly comparable to the less

than 10 minutes charging enabled by the latest battery technologies combined with megawatt-scale charging for electric cars (see [Chapter 8](#)).

While ultra-fast charging solutions are becoming an increasingly competitive alternative to battery swapping, they are currently limited to few models and could place significant additional strain on electricity grids. Frequent use of ultra-fast charging may also [accelerate](#) battery degradation, although the extent to which this could meaningfully limit battery lifetime depends largely on battery technology and quality, as well as on how frequently ultra-fast charging is used.

Battery swapping decouples vehicle recharge and battery recharge, offering a service that combines speed and limited strain on power grids, as batteries are recharged more slowly at the swapping station. This operating model also allows charging conditions to be optimised and battery state-of-health to be closely monitored, supporting longer battery lifetimes and facilitating reuse and second-life applications. In addition, batteries stationed at swapping facilities can potentially provide grid services, such as peak shaving, offering additional revenue streams while supporting power system flexibility. Battery swapping can also enable business models that reduce EV upfront costs, particularly where vehicle ownership is separated from battery ownership and batteries are retained by the swapping operator. Given that batteries typically account for between one-quarter and one-third of the cost of an electric car, this can substantially lower purchase prices for consumers, although battery leasing costs might limit or cancel advantages in the long term.

Despite these advantages, the deployment of battery swapping faces several challenges. Economic viability generally requires a sufficient degree of standardisation across battery packs, as well as vehicle designs that are compatible with specific swapping systems – requirements that are not met by the majority of vehicles in operation today. Progress is being made through the development of international standards, such as the [IEC-62840-1](#) 2025 standard, and through industry-led initiatives aimed at standardisation. Examples include CATL's [#20 and #25](#) battery models for passenger cars and the [#75](#) battery system for heavy-duty trucks, as well as NIO's strategy of making [all](#) of its models battery-swap compatible. In 2025, CATL and NIO formed a strategic [partnership](#), contributing to the development of what is currently the world's largest battery-swapping network.

High upfront investment requirements can also constrain the rollout of battery-swapping infrastructure. For example, the battery inventory required at a typical NIO passenger-car swapping station – [23 battery packs](#) with capacities ranging from 75 kWh to 100 kWh – represents an investment of approximately USD 170 000 to USD 230 000 at 2025 global average market prices. This figure would rise to approximately USD 440 000 for a truck swapping station hosting twenty-four [171 kWh modular packs](#). In addition, these stations require additional investments for the construction of the swapping station itself, which often rely on automated systems, and associated software. When considering all these

elements, reported costs for a NIO light-duty battery-swapping station in China range from around [USD 200 000 to just over USD 400 000](#).

Battery swapping stations for 2/3Ws face lower upfront investment needs, easing their deployment. These systems often consist of relatively simple cabinets in which users manually exchange batteries, and they rely on much smaller batteries than those used in passenger cars or trucks. For example, the battery inventory for a 2W swapping station equipped with 30 batteries of 3 kWh each would cost around USD 12 000 at average global battery prices in 2025. As a result, the deployment of battery swapping for 2/3Ws is more geographically diversified than for passenger cars and trucks, which remain largely concentrated in China. Swapping systems for 2/3Ws are increasingly deployed across other Asian markets – including India and Indonesia – as well as in several African countries, such as Kenya, Rwanda and Uganda. The total installed battery capacity at these stations is substantially lower than in swapping stations for electric cars and trucks.

**Figure 6.8. Estimated share of swapping stations and associated battery capacity by mode and region, 2025**

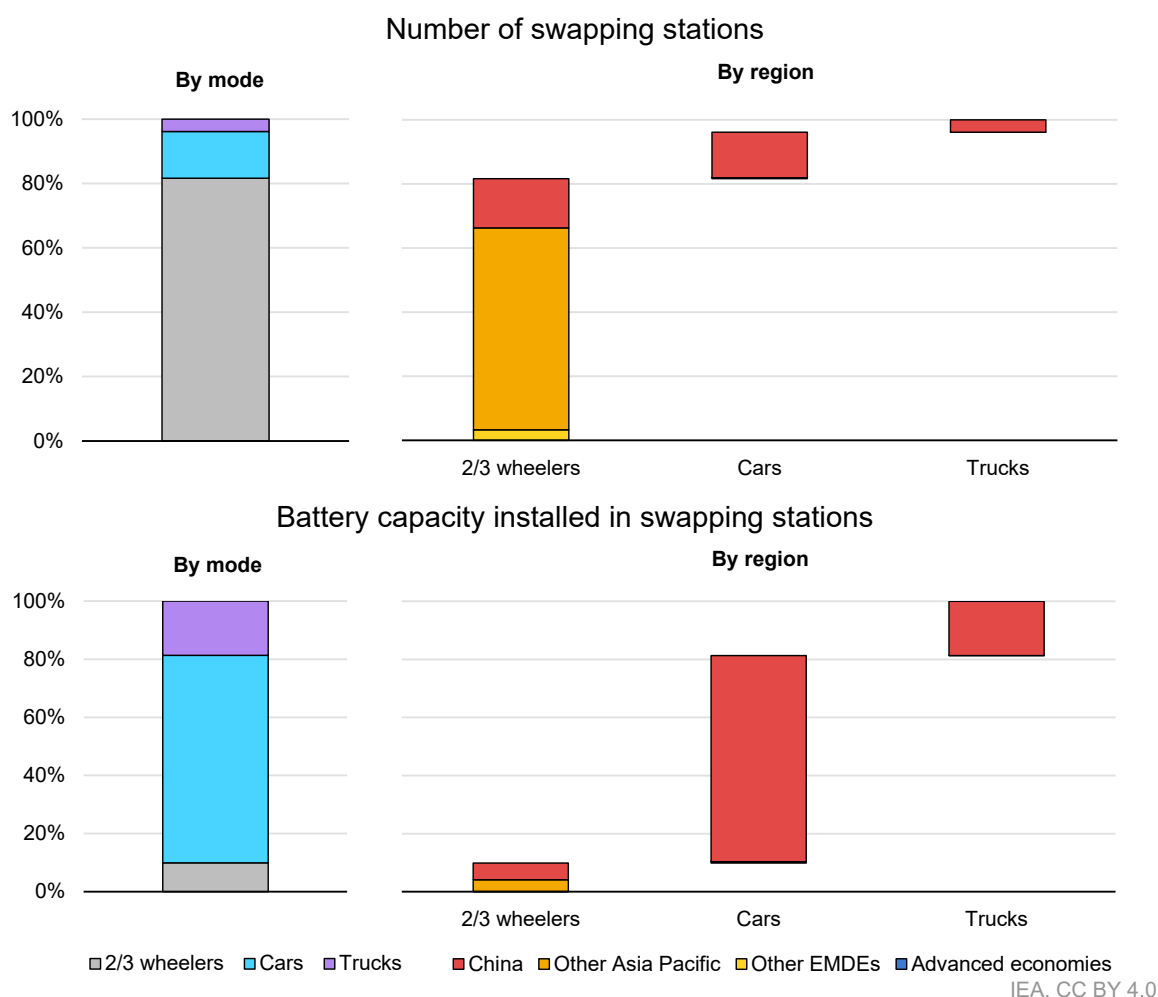

Notes: EMDEs = emerging markets and developing economies. This analysis uses the sales-weighted average battery size for 2/3 wheelers (5 kWh), cars (100 kWh), and trucks (210 kWh). The number of stations and vehicles are based on the variety of sources listed in [Annex F](#).

## Two- and three-wheelers are the most popular vehicle type for battery swapping in many emerging markets

**Chinese Taipei's** Gogoro, the largest battery swapping operation in the country, operates a large battery scooter ecosystem, with more than [600 000 scooters](#) across more than 12 500 stations in the region. Gogoro's efforts are supported by partnerships with original equipment manufacturers (OEMs) such as [Yamaha and Suzuki](#), which build electric scooters that are compatible with the Gogoro battery and swapping infrastructure.

In **India**, battery swapping involves a [diverse](#) set of players including SUN Mobility, Gogoro, Battery Smart, RACE Energy, Charge Up and Bounce Infinite. At least 60 000 2/3Ws equipped for battery swapping are already in operation, supported by business models offering both Battery-as-a-Service (BaaS) and Mobility-as-a-Service (MaaS).<sup>31</sup>

**Southeast Asia** is also seeing continued development of battery swapping for 2/3Ws. In **Indonesia**, the Asian Development Bank and the Australia Climate Partnership awarded PT TBS Energi Utama Tbk (TBS) a funding package of [USD 10 million](#) in 2024 to promote the deployment of e-motorcycles and battery swapping stations. In 2021, **Thailand** set a target of [1 450 swapping stations](#) for motorcycles by 2030.

In **Africa**, battery swapping for 2/3Ws is beginning to scale, led by a small number of dedicated operators. Spiro, an electric motorbike manufacturer and battery swap service provider, has deployed around [22 000](#) electric motorbikes across 7 African countries. In **Uganda**, Spiro currently operates [105 swapping stations](#) and has recently secured an additional [USD 63 million](#) to support further expansion in the country. In **Kenya**, the company has deployed over [7 500 vehicles](#) supported by more than 200 swapping stations. It also operates over [100 swapping stations](#) in **Rwanda**. A 2/3W battery swapping network is also being developed in **Ghana**, with commitments from Shell and the UK Government to deploy [100 swapping stations](#).

In **South America**, Gogoro announced the first electric motorbikes battery swapping stations in [Chile](#) and [Colombia](#) in 2024, and the São Paulo-based Vammo is piloting [over 150 battery swap stations](#) in Brazil.

---

<sup>31</sup> Battery-as-a-Service (BaaS) separates battery ownership from the vehicle, with users paying to access the battery while the provider manages its lifecycle. Mobility-as-a-Service (MaaS) provides on-demand access to multiple transport modes on a digital platform, replacing vehicle ownership with service-based mobility.

## Battery swapping for cars is scaling up where there is strong policy and industry alignment

The deployment of battery swap-capable car and associated stations remains largely concentrated in **China**, where public support – the Chinese government has provided [over USD 4 billion](#) for the development of battery swapping stations – and industry investments align.

CATL, the world's largest battery producer, has developed two standard battery designs, the [#20 and #25](#) models, and plans to install [30 000 electric car battery swapping stations](#) in the long term, of which over [1 000](#) were already deployed in 2025 and [3 000](#) are targeted by the end of 2026. NIO, one of the leading Chinese electric car manufacturers, produces models that are [all battery-swap compatible](#), and has built about 3 800 swapping stations since 2018. At the beginning of 2026 NIO reached the milestone of having completed [100 million](#) swapping services. In 2025, NIO and CATL also formed a strategic [partnership](#), establishing the world's largest battery-swapping network. In the same year, CATL also signed a framework agreement with Sinopec, China's state-owned oil major, to jointly construct [10 000 swapping stations](#) in the future.

The development of battery swapping networks in the **United States** has been limited. Tesla discontinued its battery swapping initiative in [2015](#), due to limited interest from EV car owners. In 2021, Ample deployed [five automated battery swapping stations](#) in San Francisco, designed to serve the Nissan LEAF and certain versions of the Kia Niro. However, Ample filed for [bankruptcy](#) in December 2025, citing a contraction in global EV investment, supply chain challenges and regulatory and permitting delays.

In **Europe**, interest in the deployment of battery swapping solutions has increased recently, but deployment to date remains very limited in scale. NIO currently operates [60 stations in Europe](#). CATL announced in 2025 its intention to establish a [battery-swapping network](#) in Europe, primarily focusing on the car market.

## Battery swapping can offer advantages to electric truck fleets, but has so far been concentrated in China

Battery swapping is well suited to standardised truck fleets operating on predictable routes, which could help to unlock the investments required for such stations. Their use and deployment, similarly to for cars, is today concentrated in **China**, where [around one-third](#) of battery electric truck sales were battery swap-capable in 2023, 2024 and 2025. China's U Power, SAIC Hongyan, together with Dutch EV firm UNEX EV, also signed a Memorandum of Understanding to deploy [4 200 battery-swap capable trucks](#) in **Thailand**.

**Europe's** first fully automated heavy-duty electric truck battery swapping station opened in Germany in [2023](#), and a number of OEMs are collaborating [on technology development](#). In the **United States**, battery swapping projects for trucks are mostly in the pilot development stage. In early [2024](#), Revoy introduced an alternative approach based on a swappable electric drive module for heavy-duty trucks, reportedly capable of adding around [250 miles of electric range](#). The system attaches externally between the tractor and trailer and can enable conventional diesel trucks to operate as a hybrid vehicle, or act as a range extender for electric trucks.

## Electric road systems face deployment challenges despite ongoing pilots

### High costs limit deployment of electric road systems, despite advantages in specific applications

Electric road systems (ERS) enable vehicles to recharge while driving through dynamic charging technologies. This can be achieved either through conductive or inductive systems. In conductive ERS, an arm or sliding connector is used to connect the vehicle to catenary (over-head) lines – similar to those used in tram systems – or with contact rails embedded in the road surface. Inductive (wireless) systems rely on electromagnetic coupling between two coils: one installed beneath the road surface and connected to the power grid, and another mounted on the vehicle. The first coil uses grid electricity to generate a magnetic field, which is captured by the vehicle-side coil and converted into electricity to power the vehicle or recharge its battery.

Electric road systems offer several potential advantages. By enabling vehicles to recharge while in motion, ERS can significantly reduce the need for large onboard batteries, alleviate range anxiety and allow for longer driving distances without stopping to recharge. However, these systems also face important challenges. Capital costs are [high](#) – typically [estimated](#) at between USD 1-3 million per kilometre for conductive systems and roughly USD 4 million per kilometre for inductive systems – and deployment of such infrastructure requires long lead times. In addition, vehicles must be equipped with compatible hardware, such as conductive connection arms or inductive charging coils. Conductive systems are also less flexible across vehicle classes, as vehicles of different sizes (e.g. cars and trucks) may require separate infrastructure designs, whereas inductive systems can be more easily standardised. Governance can also be difficult, as ERS requires a market design appropriate for both the transport and energy market, which have distinct regulatory regimes.

Over recent years, several electric road pilots and demonstration projects have been deployed, enabling technology testing and incremental improvements (Table 6.1). However, faster progress in conventional technologies – including declining battery costs, improved battery fast-charging capabilities and the rapid expansion of fast and ultra-fast charging infrastructure – have [reduced](#) the relative value proposition of ERS. Nonetheless, there are applications where the advantages of ERS may outweigh its drawbacks, particularly on heavily used freight corridors and dedicated highway sections for trucks, or in locations with frequent short stops, such as inductive charging installations at traffic light stops or at logistics hubs during loading and unloading operations.

**Table 6.1 Operational, planned and decommissioned electric road system projects**

Location	Length/Capacity	Type	Status (Year)
<a href="#">Arena del Futuro</a> , Lombardy, Italy	1 km	Inductive	Pilot completed (2021)
<a href="#">Cologne</a> , Germany	N/A	Inductive	Pilot completed (2021)
<a href="#">Geneva</a> , Switzerland	12 buses	Catenary	Operational (2022)
<a href="#">Xinjiang province</a> , China	1 800 km	Catenary - Trucks	Planning stage (2023)
<a href="#">Datong</a> , China	N/A	Catenary - Trucks	Private pilot project (2023)
<a href="#">Jilin province</a> , China	120 m	Inductive	Pilot/demonstration ongoing (2023)
<a href="#">Gotland</a> , Sweden	1.6 km	Inductive	Pilot completed (n/a)
<a href="#">Kashiwa</a> , Japan	Traffic light stops	Inductive	Pilot ongoing (2023)
A1 <a href="#">Bundesland</a> , Germany	5 km	Catenary	Pilot completed (2024)
B 462 <a href="#">Baden-Württemberg</a> , Germany	3.5 km	Catenary	Pilot completed (2024)
A5, <a href="#">Hessen</a> , Germany	17 km	Catenary - HGV	Pilot completed (2024)
<a href="#">E20 Hallsberg-Orebro</a> , Sweden	N/A	Mixed	Cancelled (2025)
<a href="#">A10</a> , Angervillers, France	1.5 km	Inductive	Pilot ongoing (2025)
<a href="#">Chamonix Mont Blanc Valley</a> , France	N/A	Inductive	Pilot completed (2025)
A6 <a href="#">Bayern</a> , Germany	N/A	Inductive	Pilot/demonstration ongoing (2025)
<a href="#">Trondheim</a> , Norway	40 km	Inductive	Planned (2025)
<a href="#">Indiana</a> , United States	N/A	Inductive	Pilot ongoing (2025)
<a href="#">Karlsruhe</a> , Germany	100 m	Inductive	Pilot ongoing (2026)
<a href="#">California</a> , United States	N/A	Inductive	Planning stage (2028)

Note: N/A = not available.

# Chapter 7. Trends in manufacturing and trade

## Manufacturing and trade of electric cars

### Global electric car output reached record levels in 2025 while European production rebounded

Nearly 22 million electric cars were produced globally in 2025 – up more than 25% compared to the previous year. Of those, about one-quarter were traded between major production and demand centres. The **People’s Republic of China** (hereafter, “China”) remains the world’s largest hub for manufacturing and trade of electric cars, capturing nearly 75% and 40% of the respective global totals. Primarily led by domestic carmakers, China’s 2025 production of 16 million electric cars outstripped domestic demand by 20%, pushing Chinese electric car exports to double to a record high of more than 2.5 million. At the same time, exports of conventional cars from China remained at a level relatively similar to 2024 – meaning that electric cars were the primary driver of growth in car exports. In 2025, electric models represented more than 35% of all Chinese car exports, up from about 20% the year before.

**Figure 7.1 Production of electric cars by region and location of car manufacturer headquarters, 2021-2025**

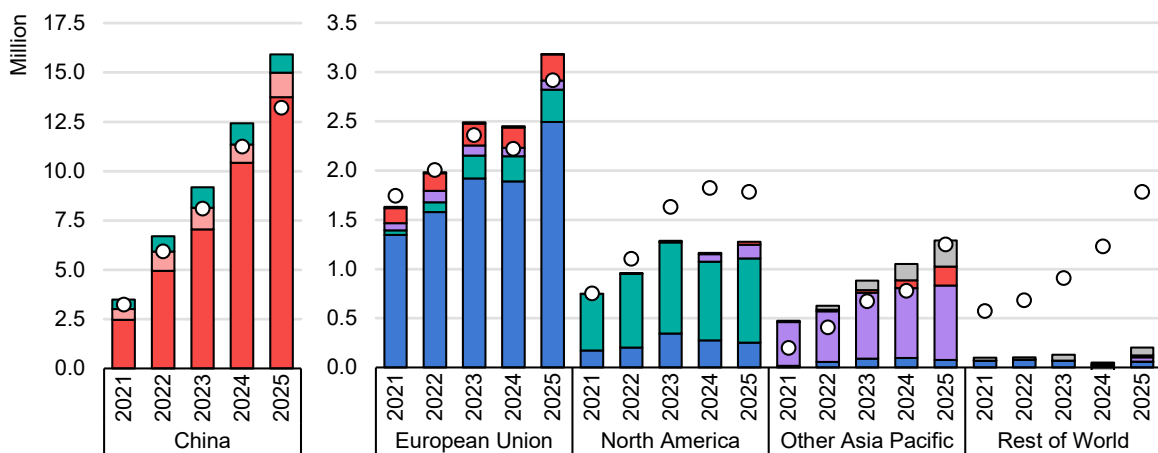

**Location of OEM headquarters:**

■ European Union ■ United States ■ Japan and Korea ■ China ■ China (JV) ■ Rest of World ○ Domestic sales

IEA. CC BY 4.0

Notes: OEM = original equipment manufacturer; JV = joint venture. Tesla is the only foreign OEM producing electric cars in China that is not part of a joint venture with a Chinese OEM. See the [Annex I](#) for regional groupings.

Sources: IEA analysis based on [Benchmark Mineral Intelligence](#) and [EV Volumes](#).

In the **European Union**, policy-driven growth in electric car sales resulted in production increasing 30% from 2024 to reach nearly 3.2 million in 2025. The European Union remained the world's second-largest electric car producer. Domestic carmakers continued to capture the majority of the regional output, while the remaining less than 20% was primarily produced by Chinese players (through Geely's Volvo) and US carmakers (mostly from Tesla and Ford's European plants). The region remained a net exporter of electric cars, with exports exceeding 1 million in 2025 – a 25% rise from the previous year. Other European countries, principally the United Kingdom, continued to be the main destinations for EU exports, representing two-thirds of the total. Recent tariff hikes in the United States reduced North America's share of EU exports by nearly four percentage points, though export volumes were similar to 2024 levels. Despite growing exports, the EU net trade balance narrowed as imports went up around 35% year-on-year to reach more than 900 000 in 2025. China accounted for almost 60% of these, equivalent to less than 20% of EU demand, a similar share to the previous year. Chinese-made electric cars sold in the European Union are increasingly shifting to Chinese brands, including Chinese-owned legacy European brands such as Volvo Cars and MG. The share of Chinese brands in total imports from China grew from 50% in 2023 to more than 70% in 2025, while the share of Chinese-made electric cars from Tesla fell from 30% to 10% over the same period.

Electric car production in **other European countries** was lower than domestic demand. In 2025, despite some growth in domestic production, those countries continued to rely significantly on imports, primarily from the European Union (representing over half of total sales in 2025) and China (30%). Most of the output was concentrated in Türkiye, led by Toyota and the domestic electric vehicle (EV)-maker Togg, in the United Kingdom, led by Jaguar-Land-Rover (owned by India's Tata group), and to a lesser extent in Serbia through Stellantis' assembly plant. However, as incumbent [European](#), [Japanese](#) and [Korean](#) carmakers, as well as [Chinese](#) and [Turkish](#) EV makers, expand their EV production capacity, Türkiye, the United Kingdom and Serbia are expected to play a growing role in regional electric car manufacturing and trade. In 2025, more than half of the around 150 000 electric cars they produced were exported, primarily to the European Union.

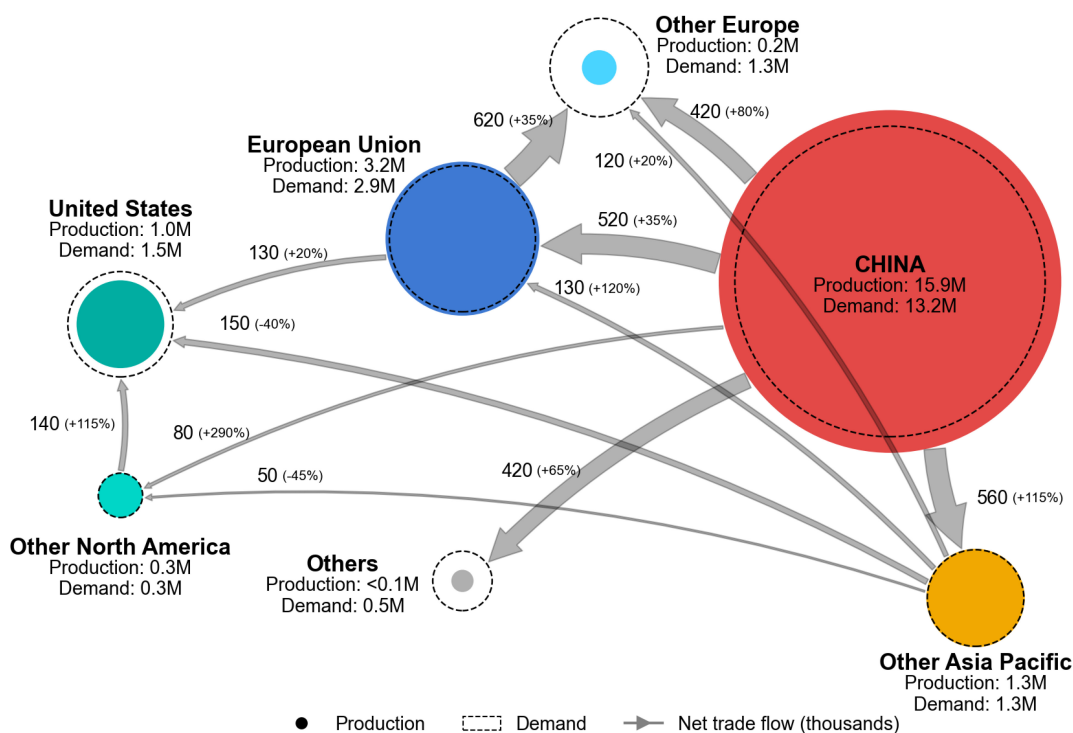
**Figure 7.2 Production, demand and net trade of electric cars in major markets, 2025**

IEA. CC BY 4.0

Notes: M = million cars. Net trade flows are in thousand vehicles and rounded to the nearest 10 000. Net trade flows under 20 000 vehicles are not shown. The 2025 growth in net bilateral trade is given in brackets. Stockpiling (the difference between exports and actual sales) of electric cars is not taken into account, and trade flows represent the number of electric cars manufactured in one country or region and sold in another region or country. See [Annex I](#) for regional groupings.

Sources: IEA analysis based on [EV Volumes](#) and [Benchmark Mineral Intelligence](#).

In 2025, after a year of decline, electric car production in **North America** returned to growth with a 10% increase from 2024, while domestic sales decreased against the backdrop of changing US policy environment and expiring Canadian EV subsidy programme. This slim increase in output was mainly driven by Korean carmakers ramping up their US production to avoid recent tariff hikes. Despite a slight decrease in imports to the United States in 2025, they remained crucial to meet demand, accounting for nearly 40% of US electric car sales. Mexico's production increased nearly 5% from 2024, the country accounted for more than one-third of US electric car imports in 2025, followed by the European Union (30%) and Japan and Korea (30% combined). Almost all of Canada's demand was met by imports in 2025, with the United States accounting for almost half of the total (more than 40% of US total exports), and Japan, Mexico, Korea and the European Union supplying the remainder. In early 2026, Canada agreed to [cut](#) its 100% tariff on Chinese electric cars in return for lower tariffs on Canadian farm products. Although initially capped at around 50 000 units, this agreement is expected to mean Chinese imports will play an increasing role in meeting Canada's demand.

Electric car output in **Asia Pacific** countries other than China also increased in 2025, albeit less rapidly than demand. Growth was primarily driven by domestic EV makers (Viet Nam's VinFast and India's Tata), and Chinese original equipment manufacturers (OEMs) ramping up production in their recently established overseas facilities; production from Japanese and Korean incumbents remained virtually constant in 2025. Trade played an increasingly important role in the region's electric car markets. Most of the region's exports originated from Japan and Korea, at levels unchanged from 2024, while their destination increasingly shifted from North America to Europe, as trade barriers with the United States grew in 2025. Imports into the region, particularly into Southeast Asia, Australia and Korea, grew markedly to meet soaring electric car sales, with China representing over 80% of total imports. In Southeast Asia, for example, electric car imports more than doubled year-on-year to exceed 300 000 in 2025, with nearly all coming from China and supplying more than half of domestic demand.

## Chinese exports continue to grow in Europe and beyond

### Tight profit margins in China push automakers into overseas markets

China's electric car exports doubled in 2025 against the backdrop of an intense [EV price war](#) in the country, which squeezed automakers' profit margins, prompting them to seek higher returns in overseas markets. In this highly competitive environment, exports also provided an additional channel to sustain production volumes, helping automakers offset the slowdown in domestic sales growth with additional revenues.

Exports also played a key role in expanding electric car adoption in a number of emerging economies, while continuing to supply established markets. In Europe, sales of Chinese-made electric cars grew almost 50% from 2024 levels to reach about 940 000 in 2025. Despite this, Europe's share in total Chinese export value continued declining to reach around 40% in 2025, reflecting the increasing importance of emerging markets for Chinese exports. In 2025, more than half of Chinese electric car sales overseas were recorded in markets other than Europe and the United States, with particularly strong growth in Southeast Asia (+130% from 2024), the Middle East (+60%) and Latin America (+55%).

In addition to diversifying their destination markets, Chinese electric car exports were increasingly led by Chinese carmakers. In 2025, four in five Chinese-made electric cars sold overseas were made by Chinese manufacturers, up from less than two in five in 2021. While exports by carmakers headquartered overseas, such as Tesla, Renault's Dacia and BMW, remained broadly stable in absolute terms, their combined share in Chinese exports declined by nearly 40 percentage points over the same period.

Behind those record high exports lies the expanding Chinese fleet of vehicle carriers. Over the past 5 years, carmakers like BYD and SAIC, along with major Chinese shipping firms, have commissioned a significant number of [roll-on/roll-off vessels](#) to serve their fast-growing overseas markets.

**Figure 7.3** Sales of Chinese-made electric cars outside China by region (left), export value shares per destination region (centre), and overseas sales by location of carmaker headquarters (right), 2021-2025

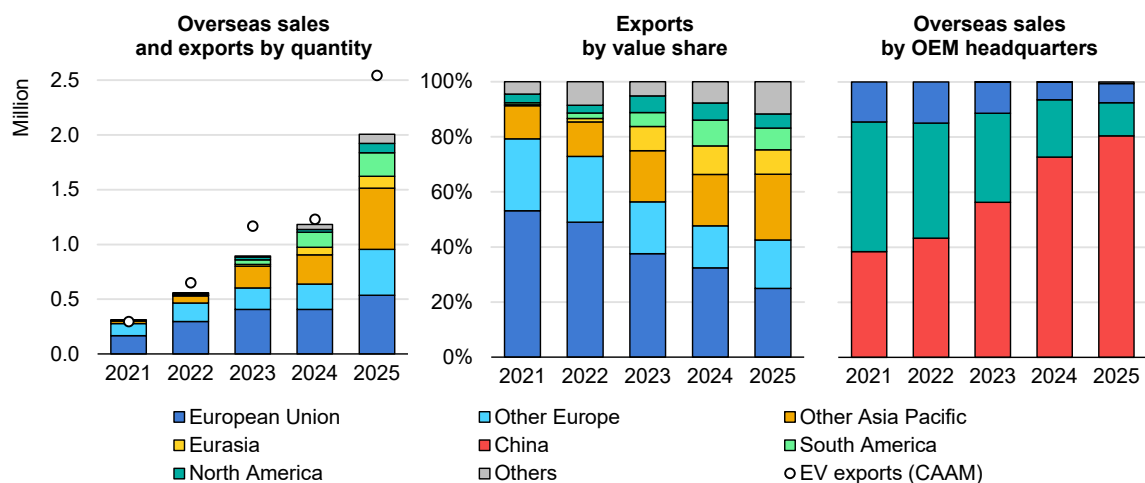

IEA. CC BY 4.0

Notes: EV = electric vehicle; OEM = original equipment manufacturer; CAAM = China Association of Automobile Manufacturers. Left and right figures use EV Volumes to represent the sales of Chinese-made electric cars in overseas markets by destination market and OEM headquarters location. Discrepancies with EV exports reported by CAAM (white dot) are explained by stockpiling of unsold Chinese electric cars in export markets. The exports by value in the central figure are taken from General Administration of Customs of the People's Republic of China (GACC) trade tables queried with Harmonized System (HS) codes 870360 and 870380, which also include low-speed EVs. See [Annex I](#) for regional groupings.

Sources: IEA analysis based on [EV Volumes](#), [CAAM](#) and [GACC](#).

### Box 7.1 The rise of “zero-mileage” used EV exports from China

Production-linked incentives, combined with fierce domestic competition and shrinking profit margins, have pushed some Chinese carmakers to seek alternative sales channels, including domestic sales and exports of used cars. In 2021, 2 years after the ban on used car exports was [lifted](#), some carmakers saw an opportunity to exploit a loophole on unused (or “[zero-mileage](#)”) used car exports. This was seen as a way to increase production and clear excess inventories without the need to ensure after-sales services and maintain a dealership network in destination markets, as is required with new car exports. This practice was also aided by [local governments](#) in China through the allocation of extra registration quotas for locally produced cars and extra export licences in order to demonstrate improved regional economic performance. Additionally, in

most destination markets, used car imports face lower tax bases or simplified import treatment compared to new vehicles, making used car exports an easier channel to sell off production.

In 2025, used car exports from China exceeded [500 000](#), up from 15 000 in 2021. Industry estimates suggest that 70% to 80% of those vehicles are in fact unused or have a near-zero odometer. Although no official powertrain breakdown is available, [most “zero-mileage” used car exports](#) are expected to be new energy vehicles (NEVs), as these vehicles are briefly registered domestically, allowing them to generate tradable [NEV credits](#), before being exported.

In response to this practice, which poses reputational risk for Chinese carmakers, the Chinese Ministry of Commerce issued a new [regulation](#) targeting used car exports, effective from January 2026 and meant as a deterrent for “zero-mileage” used car trade. Any car exported within 180 days of its first registration must now come with an after-sales service confirmation issued by the automaker.

## Imports from China underpin electric car uptake in many emerging markets

In major electric car markets – like Europe and the United States – the share of Chinese imports in sales is still relatively limited due to trade measures, consumer preferences and large domestic electric car manufacturing capacity. However, outside these two major markets, Chinese imports accounted for 55% of electric car sales in 2025, up from about 10% in 2021. Many countries in Latin America, the Middle East and Africa import more than 80% of their electric cars from China. There are some notable exceptions, for example in India and Viet Nam, where local OEMs supply most electric car demand. Additionally, some countries with well-established automotive manufacturing bases have introduced policy frameworks to promote local manufacturing of electric cars, such as [Thailand](#), [Indonesia](#), [India](#), [Malaysia](#), [Brazil](#), [Mexico](#), and [Türkiye](#). In these countries, imports from China still played a dominant role in 2025, but the share of locally produced electric cars started to grow, notably in Thailand (marking an almost 15-percentage-point increase year-on-year) and in Brazil (5 percentage points).

**Figure 7.4 Origin of electric cars sold in selected markets, 2025, and share of total imports from China, 2024 and 2025**

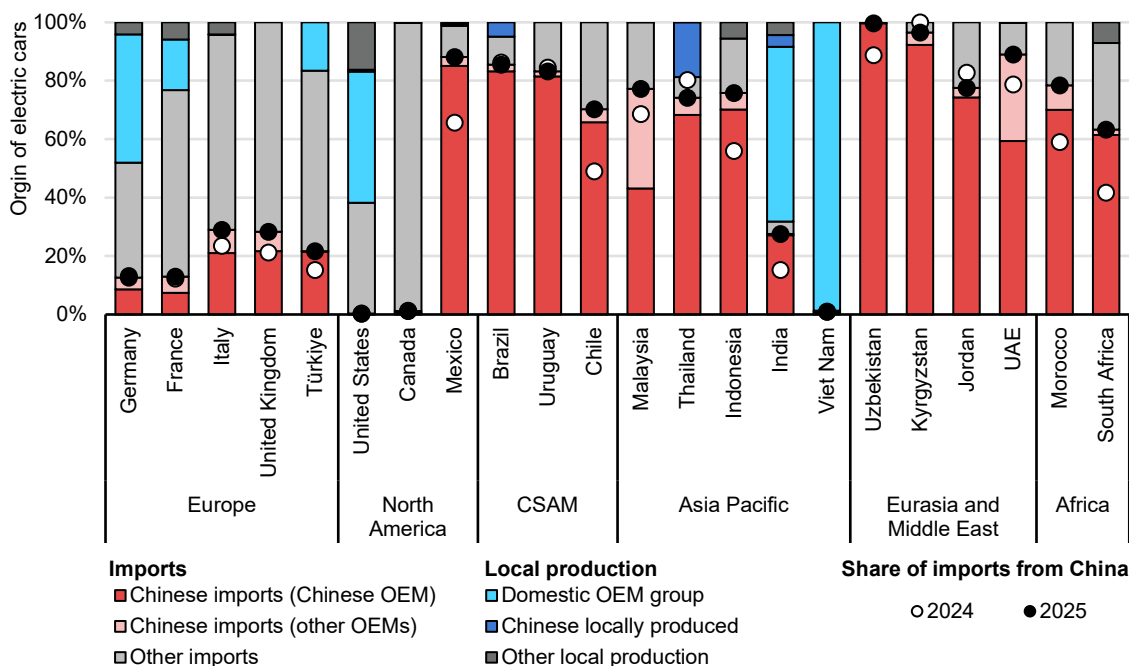

IEA. CC BY 4.0.

Notes: UAE = United Arab Emirates. Chinese OEMs include BAIC, Geely-Volvo, GWM, GAC, BYD, Chery Automobile, JAC, Neta Auto, Seres Group, FAW, Changan, Dongfeng, Jiangling Motors, SAIC, Leap Motor, Xiaopeng, Aiyways Automobile.

Source: IEA analysis based on [EV Volumes](#).

## Chinese electric car exports face headwinds in 2026 but momentum persists

Chinese electric car exports are expected to face headwinds in 2026 as overseas inventories build up. In 2025, exports reported by CAAM exceeded overseas sales by over 25%, suggesting a significant increase in overseas inventories, likely constraining additional shipments. Policy developments are adding further constraints. In January 2026, the Chinese government introduced [export licenses for BEVs](#), which replicate the export requirements that already exist for other vehicle technologies and suggest there is government concern around the reputational risks associated with unregulated export practices. Rapidly shifting trade policy settings are also likely to represent another hurdle for Chinese electric car exports in 2026. Trade restrictions in Southeast Asia, the second-largest overseas market for Chinese exports, hardened at the end of 2025 as most investment-linked waivers on import duties expired, namely in Thailand, Indonesia and Malaysia. Additionally, Thailand recently adjusted its [industrial policy](#) to incentivise electric car exports over domestic sales, positioning the country as a growing competitor to Chinese exports in the region. Major Chinese export

markets in Latin America – such as [Brazil](#) and [Mexico](#) – also introduced new duties on electric car imports, putting additional pressure on the affordability of imported Chinese electric cars.

However, the impact of growing overseas inventories and shifting trade policies on Chinese electric car exports could be partly offset by manufacturers' efforts to weather a slowdown in domestic sales growth. The first quarter of 2026 showed electric car exports more than [doubling](#) compared to the same period in 2025, while domestic NEV sales declined almost 25% over the same period. Over the course of 2026 the Chinese market is expected to adjust to the tightening purchase incentives for NEVs, which may weaken domestic sales. As a result, Chinese OEMs may increasingly rely on overseas markets to absorb production. This shift is already reflected in industry targets: the ten largest Chinese OEMs announced combined overseas sales targets exceeding 7 million in 2026, almost doubling their 2025 announcements and approaching China's total car export levels observed in 2025.

## **Southeast Asia is home to more than half of Chinese carmakers' overseas manufacturing footprint**

Industrial and trade policies of destination markets, coupled with their low labour and energy costs, have made overseas manufacturing activities increasingly attractive for Chinese carmakers over the past few years. In 2025, dual internal combustion engine (ICE)-EV overseas manufacturing capacity<sup>32</sup> owned by Chinese firms was estimated at about 1.7 million cars per year, compared to a capacity of 29 million in China.

Southeast Asia is the primary location of Chinese carmakers' overseas car assembly plants. In 2025, the region accounted for more than half of China's overseas dual ICE-EV manufacturing footprint, with Thailand and Indonesia being respectively home to more than 30% and 20% of the total. However, production has yet to ramp up: in 2025, the average Chinese capacity utilisation for battery electric car production was estimated around 20% in Thailand and below 15% in Indonesia. Utilisation is expected to rise in 2026 as regional trade policy shifts to favour local assembly over imports. The recent rise in Chinese exports of knockdown vehicle kits (semi-knocked down [SKD] and completely knocked down units [CKD]) is also likely to drive up utilisation. In 2025, [around half](#) of Great Wall's and SAIC's car exports were knockdown vehicle kits meant for final assembly in

---

<sup>32</sup> Dual ICE-EV manufacturing capacity encompasses the total vehicle production capacity of assembly plants producing exclusively EVs and assembly plants known to produce both conventional and electric vehicles on different or identical assembly lines.

importing markets. These exports allow Chinese EV makers to mitigate tariffs that are otherwise paid in full on completely built-up units (CBU), while ramping up overseas output wherever the local EV supply chain is not yet sufficiently developed for full-assembly manufacturing, as illustrated by [BYD’s plant in Brazil](#), [SAIC-GM-Wuling in Indonesia](#), or [Great Wall](#), [SAIC](#) and [Wuling](#) in Malaysia. However, some countries are tightening policies to curb this trend. In 2026, [Brazil](#) accelerated the schedule of reinstating import tariffs on SKD and CKD kits to match those applied to CBUs, effectively encouraging EV makers to shift towards higher local content manufacturing.

**Figure 7.5 Chinese overseas electric vehicle manufacturing capacity by region (left) and electric vehicle manufacturing capacity in Southeast Asia by location of original equipment manufacturer headquarters (right), 2025**

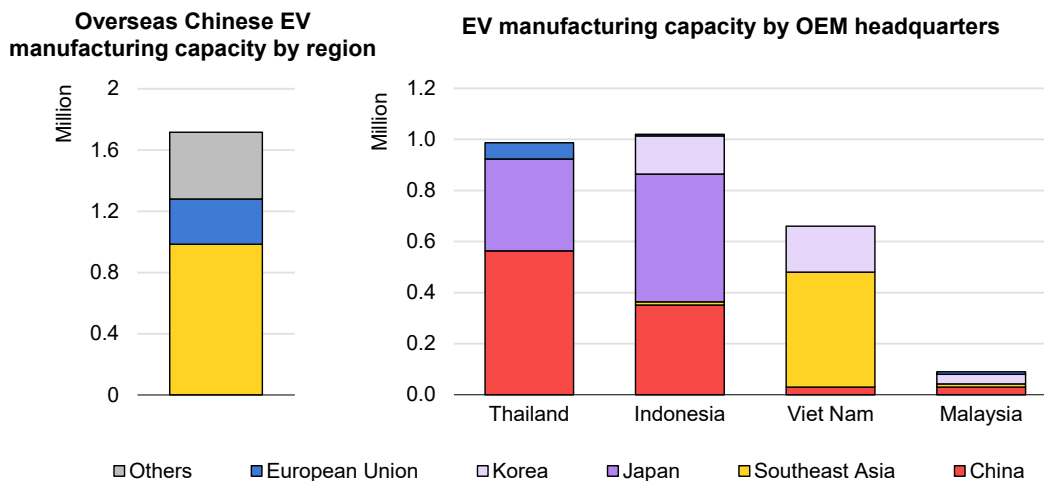

IEA. CC BY 4.0.

Notes: EV = electric vehicle; OEM = original equipment manufacturer. Manufacturing capacity refers to plants producing EVs either exclusively or alongside internal combustion engine cars without specifying the EV share. Both full-process manufacturing and knocked-down (in which premanufactured components are imported and assembled) types of assembly plants are considered.

Source: IEA analysis based on [Benchmark Mineral Intelligence](#).

Incumbent automakers like Japan’s Toyota and Korea’s Hyundai own the largest dual ICE-EV manufacturing capacity in Southeast Asia, totalling 1.2 million cars. However, only a handful of their assembly lines are producing electric models; in 2025, they produced fewer than 2 500 electric cars across these plants. However, rising output from Chinese OEMs is set to intensify competition, and to challenge the EV production ramp-up of incumbents operating in Southeast Asia.

Q Why are electric cars made in China so much cheaper than those made in other countries?

China has emerged as the world's most cost-competitive centre for car manufacturing, particularly for electric vehicles (EVs), increasingly shaping global markets. Central to China's cost advantage is its ability to manufacture at large scale: Some of the largest EV factories in the country can produce over 1 million cars per year, well above typical outputs of plants elsewhere. These economies of scale generate major cost savings, as fixed costs can be spread across more vehicles.

Generous subsidies and preferential financing were also instrumental in enabling China to reach such scale, helping manufacturers expand production and reduce prices during the early years of market growth. It is likely that these policies continue to influence cost structures today, but they alone are not sufficient to explain the consistently lower prices.

Producing an internal combustion engine (ICE) car in China is 30% less costly than in Germany. This cost advantage is partially driven by lower labour costs, which are roughly three to five times lower than in most advanced economies. Energy costs account for between 1% and 4% of the cost of manufacturing a car, meaning that differences in energy prices do not significantly affect the overall cost gap.

When it comes to electric cars, China's production cost advantage is even greater, because of lower battery costs.

Chinese firms dominate global production of battery components, cells and packs, reaching economies of scale that manufacturers elsewhere cannot yet match. Over a decade of mass production experience enables China to build and efficiently operate highly automated factories: manufacturing efficiency alone accounts for over 40% of the battery production cost gap between China and Europe. The widespread adoption of lithium iron phosphate (LFP) batteries further strengthens this advantage by avoiding the costlier materials used in nickel-based chemistries, which remain more common in advanced economies.

However, cost structures can evolve. Other regions could narrow the gap by scaling up EV production, developing specialised EV industrial clusters and benefiting from learning by doing in battery manufacturing. Strategic choices including the adoption of cheaper chemistries, industrial partnerships and sustained electric car demand could enable other regions to close the cost gap.

**PRICE ESTIMATES OF A SMALL SUV IN SELECTED COUNTRIES IN USD, 2024**

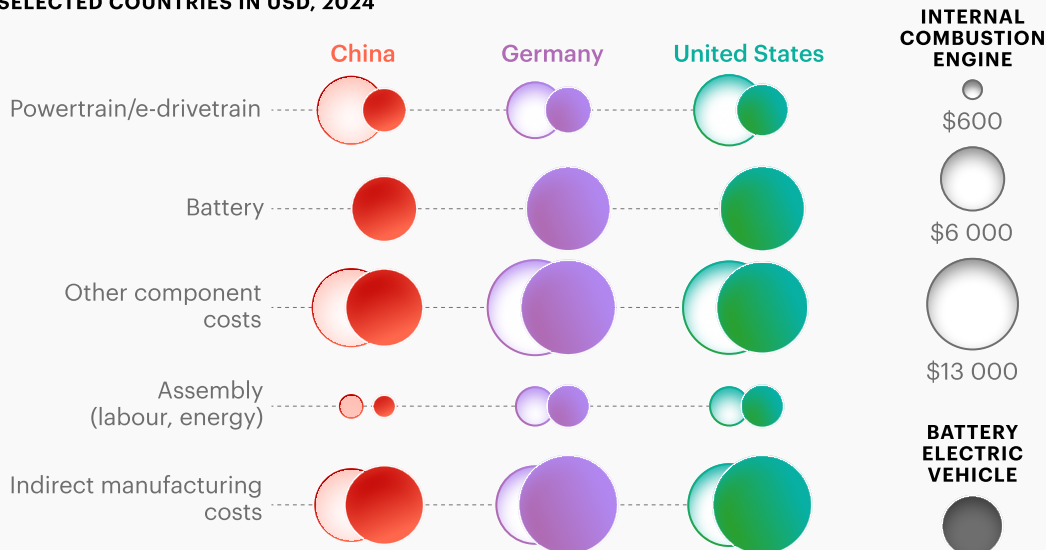

## Manufacturing and trade of electric trucks

### Only 1% of electric trucks produced in 2025 were traded

In 2025, global electric truck production reached around 440 000 trucks, more than twice as many as in 2024. More than 90% of production was concentrated in China and just over 3% in the European Union. Despite the strong increase in production, trade remained limited, with only around 3% of electric trucks produced globally in 2025 being traded (just over 12 000 vehicles), down from a peak of around 8% in 2023. By comparison, around one-quarter of electric cars produced were traded last year.

**Figure 7.6** Net exports and share of electric truck production traded in major markets, 2023-2025

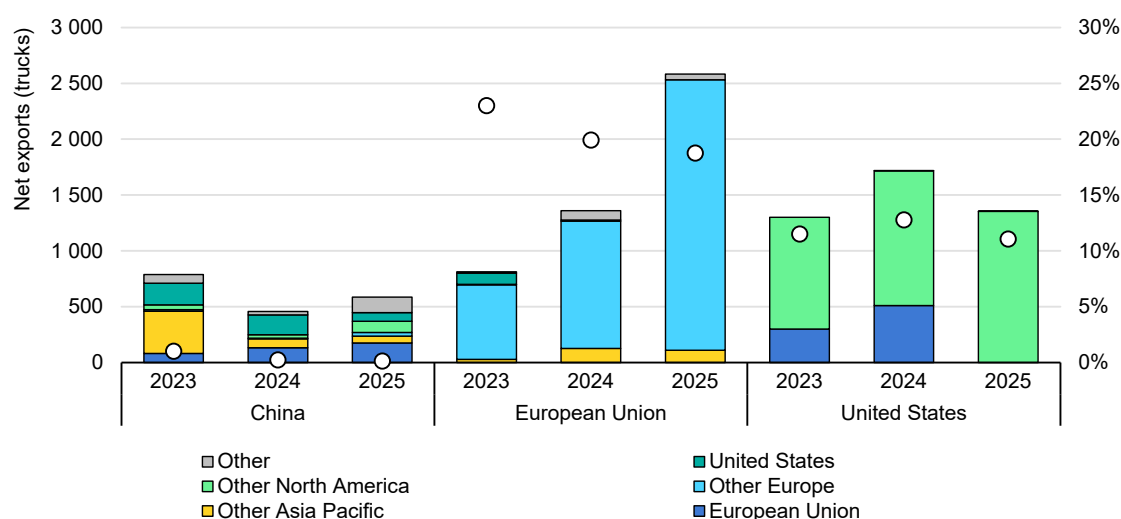

IEA. CC BY 4.0.

Notes: Regions in the legend represent importers. Stockpiling (the difference between exports and actual sales) of electric trucks is not taken into account, and trade flows represent the number of electric trucks manufactured in one country or region and sold in another region or country. "Other Asia Pacific" comprises Australia, New Zealand, Japan, Korea, India and Southeast Asia. Where the vehicle production location is unknown (in about 2% of cases), the production location is set equal to the sales region.

Sources: IEA analysis based on [EV Volumes](#) and [Benchmark Mineral Intelligence](#).

In **China**, production of electric trucks has been on the rise since 2020, exceeding 400 000 vehicles in 2025 alone, more than the cumulative production recorded between 2020 and 2024. Most of the electric trucks produced in China were destined for the domestic market, with exports representing less than 0.5% of production, mostly to North America and Europe. Chinese truck manufacturers dominate the global electric truck market largely because of the size of the domestic market. However, the competitive landscape differs from the conventional truck sector. In 2025, the five largest conventional truck makers in China (Sinotruk, BAIC, FAW, Shaanxi and Dongfeng) together accounted for less than half of electric truck sales, despite representing nearly 90% of the overall

Chinese truck market. New entrants from machinery and heavy industry, such as XCMG and Sany, have steadily gained market share since 2020. In 2025, almost 30% of the Chinese electric truck market was captured by new entrants without ICE models in their line-ups.

European manufacturers are also looking to expand in the Chinese market. Scania, for instance, has announced a [EUR 2 billion](#) investment in a new facility in China capable of producing both ICE and battery electric trucks, with around half of its output expected to be exported to Asia Pacific markets. Meanwhile, some Chinese OEMs are looking to expand overseas. For example, [Sany](#) is planning to expand production in South Africa, Brazil and Europe.

**Figure 7.7 Truck market shares by manufacturer group and location of headquarters in major markets, 2025**

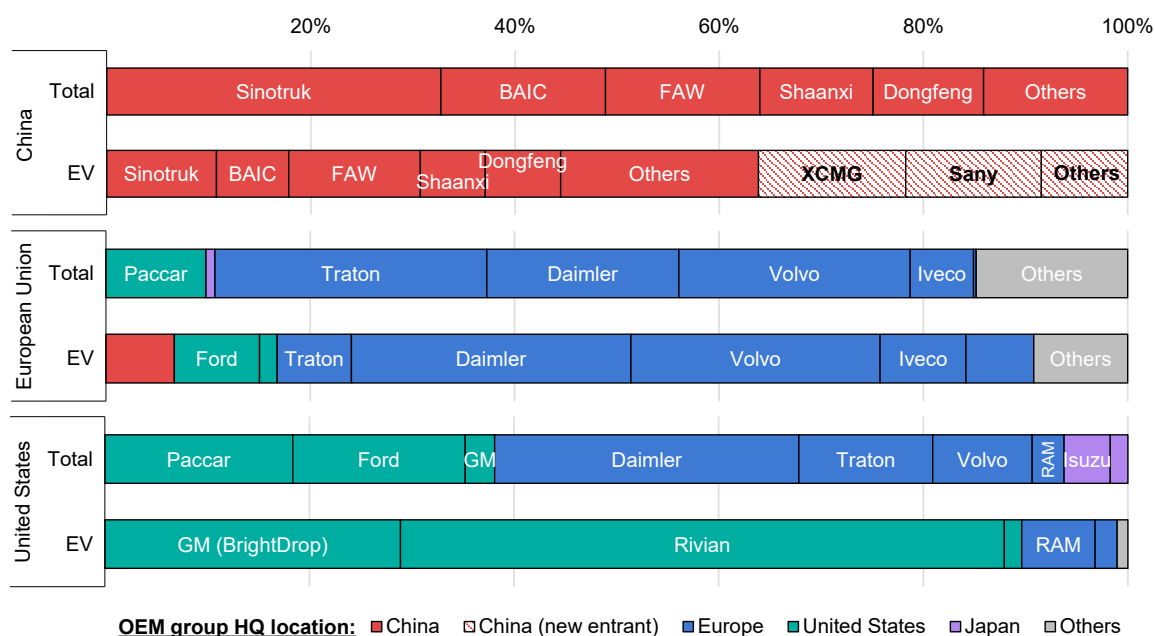

IEA. CC BY 4.0.

Notes: EV = electric vehicle; OEM = original equipment manufacturer; HQ = headquarters. Both medium- and heavy-duty trucks, above 3.5 tonnes, are considered. In the EU market, US Paccar sales are those of the Dutch truck brand DAF. Unlike Volvo Cars, Volvo Trucks has retained its European ownership. Total truck manufacturer market shares in the European Union are based on ICCT data. Marklines is used for the total Chinese truck market while EV Volumes is used for the EU and Chinese electric truck markets shares.

Sources: IEA analysis based on [EV-Volumes](#), [MarkLines](#) and [ICCT](#).

In 2025, electric truck production in the **European Union** doubled from 2024 levels to exceed 13 000 trucks. Despite production being much lower than in China, the European Union remained the world’s second-largest exporter of electric trucks in 2025 – after Canada, where BrightDrop electric trucks are produced for the US market – with export volumes doubling year-on-year to over 2 500, representing around 20% of the region’s production. More than 90% of these exports were directed to other European countries, with the United Kingdom

receiving about 40% and most of the remainder going to Norway and Switzerland. Established European truck makers (Daimler, Volvo Trucks, Iveco and Traton) still command two-thirds of electric truck sales within the European Union. However, in 2025, a few foreign manufacturers also made strides: medium-duty models from Chinese SAIC's Maxus brand and US-based Ford together captured over 10% of the electric truck market.

Established truck makers are also advancing their industrial capabilities: [Daimler](#) and [Volvo](#) can now assemble battery electric trucks on the same production lines as their diesel models, and [Traton](#) is considering the addition of another battery assembly facility in Europe. Scania, part of the Traton Group, had previously [struggled](#) to secure battery cells from Northvolt and, following Northvolt's bankruptcy, [acquired](#) Northvolt Systems' Industrial Division in 2025 to support its expansion into industrial off-road applications.

Chinese manufacturers are also looking to establish assembly lines in Europe as demand grows. [BYD](#) has established a presence in the commercial vehicle sector in the region, with electric truck models already being deployed by European logistic operators. In 2025, the company also unveiled plans to [expand](#) its existing commercial vehicle assembly plant in Hungary. Chinese truck maker [Sany](#) has announced the release of its Chinese-made e263 electric tractor in Europe, with first deliveries expected for 2026, as well as [plans for local production](#). Other Chinese new entrants, such as [SuperPanter](#) and [Windrose](#), are pursuing localisation strategies, shipping key truck modules and components for final assembly in the European Union. These developments point to a likely intensification of competition between established European and North American truck makers and their Chinese competitors within Europe.

In the **United States**, around 12 000 electric trucks were produced in 2025, but exports fell 20%, having grown steadily through 2024. The medium freight segment accounted for the majority of domestic production and almost all exports, unlike in the European Union or China.

Market entry has proved difficult for a handful of new manufacturers in the United States and Europe. In the past 3 years, several start-ups focused on electric trucks filed for bankruptcy, including [Nikola](#), [Bollinger Motors](#), [Proterra](#), [Arrival](#) and [Volta](#), and were subsequently acquired by larger truck makers and industrial players.

## Electric truck chassis production is typically domestic

The electric truck supply chains in each of the major regions outlined above differ significantly. Of the three, **China** has the most integrated and geographically concentrated ecosystem. Electric truck sales in China are almost exclusively from Chinese OEMs using Chinese batteries (with CATL supplying 80% of the total) and Chinese truck chassis, reflecting a well-connected domestic network and

strong local supplier density. The supply chain in the **European Union** has a different makeup, with truck manufacturers being predominantly European, and chassis production largely located within the region, although the battery supply chain remains heavily dependent on Chinese, Japanese and Korean companies. Around 70% of trucks sold in the European Union in 2025 were equipped with battery cells produced by manufacturers headquartered in these countries. In the **United States**, the picture is mixed: while both US- and Europe-headquartered truck manufacturers operate in the country, nearly 90% of the electric trucks sold in 2025 had batteries made by Korean and Japanese companies.

**Figure 7.8** Share of electric truck sales by location of truck and battery manufacturers' headquarters, chassis origin and production location, 2025

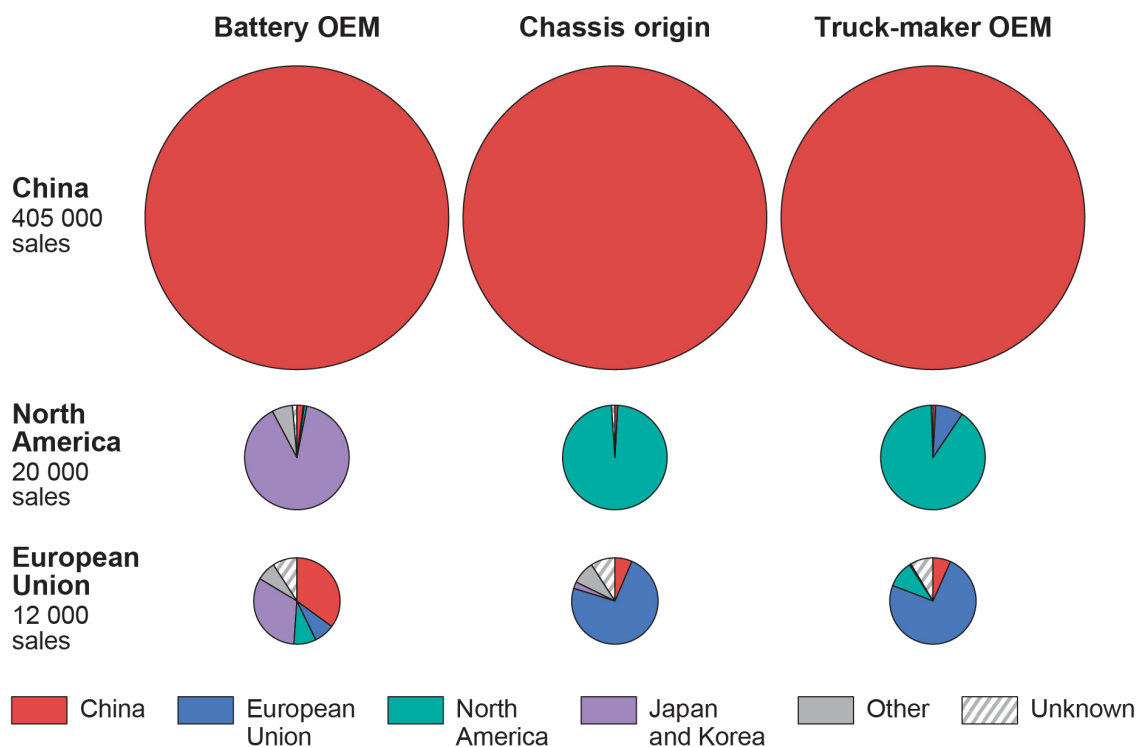

IEA. CC BY 4.0.

Notes: OEM = original equipment manufacturer. Unknown refers to vehicle sales of unidentified trucks for which only the sales region can be assigned. Battery OEM describes where the battery manufacturers are headquartered. Chassis origin describes the country where the truck chassis was manufactured. Truck-maker OEM describes where the truck brand is headquartered.

Source: IEA analysis based on [EV Volumes](#).

Electric trucks are not currently highly traded, which is reflected in supply chain patterns. Heavy vehicles are costly and logistically complex to ship over long distances, and they often require market-specific modifications for homologation and other regional regulatory compliance. Local production also generally supports after-sales service networks, enabling faster warranty handling,

maintenance and parts availability. Fleet operators therefore frequently [prioritise suppliers](#) that can offer local supply assurance and dense service coverage, reinforcing incentives for manufacturers to anchor production and delivery capabilities within the regions where the trucks are sold and operated.

## Battery manufacturing and trade

### Companies headquartered in China, Korea and Japan power the global battery industry

Global nameplate manufacturing capacity for lithium-ion batteries reached more than 4 TWh by the end of 2025, up roughly 30% compared to 2024. Year-on-year capacity growth was even faster in the European Union and the United States (at about 50%) than in China (at just over 25%). Capacity outside the largest production regions grew faster still, almost doubling between 2024 and 2025, driven largely by the [opening](#) of Envision AESC’s plant in Sunderland, United Kingdom, and investments in Southeast Asia. Nonetheless, global battery manufacturing capacity remains geographically concentrated. China accounts for over 80% of the global total, while the European Union and the United States account for 6-7% each.

**Figure 7.9 Installed electric lithium-ion battery cell nameplate manufacturing capacity by region and location of manufacturer’s headquarters, 2025**

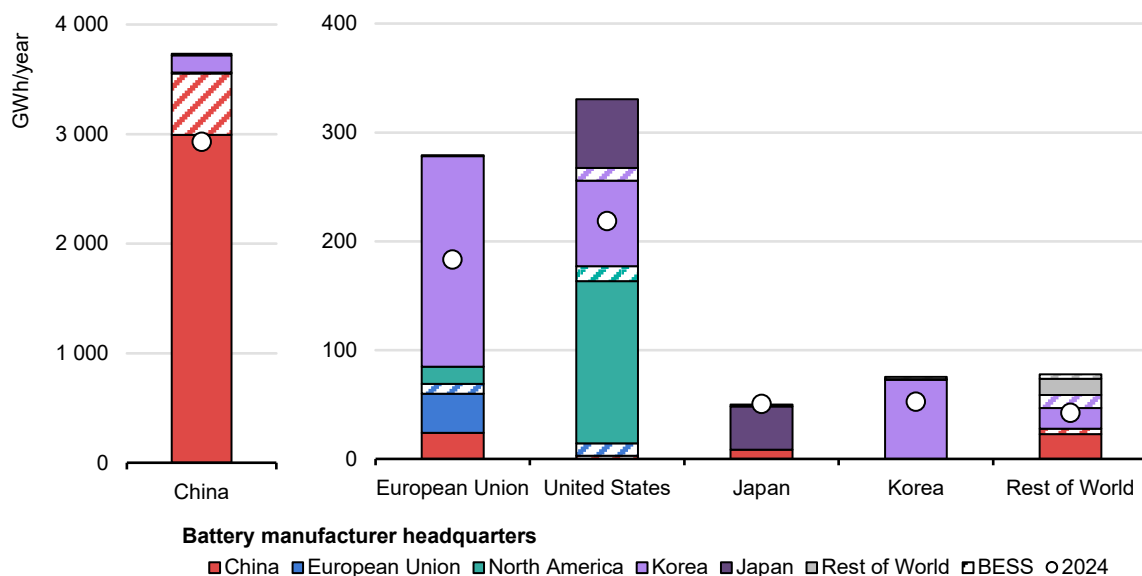

IEA. CC BY 4.0.

Notes: BESS = battery energy storage system. Pattern (dashes) indicates manufacturing capacity primarily intended for BESS, while solid colours represent capacity primarily targeting electric vehicles. For companies headquartered in a country but owned by companies headquartered in a second country, the headquarters of the owning company is considered for this analysis. The manufacturing capacity of joint ventures is shared as a function of ownership shares as of the end of March 2026.

Source: IEA analysis based on data from [Benchmark Mineral Intelligence](#).

Building production capacity is only the first step in developing a competitive industrial base. For most facilities, it can take [more than 5 years](#) from the start of operations to reach levels close to nominal output. For example, Tesla’s fully in-house EV battery manufacturing remains limited, with its first large-scale production only having started in 2023, notably to supply its Cybertruck. In the meantime, the company has continued to source the majority of its EV batteries from established global players such as Panasonic, LG Energy Solution and CATL. If excluding joint ventures with Asian producers, companies headquartered in North America owned over 35% of nameplate capacity in the United States, largely driven by Tesla. Yet these firms produced only about 3% of the batteries installed in EVs sold in 2025 (Figure 7.9 and Figure 7.11).

Battery production remains geographically concentrated. China, Europe and North America together accounted for about 95% of global output between 2023 and 2025, with China being by far the largest producer, accounting for over 80% of the total in 2025.

**Figure 7.10 Electric vehicle and stationary storage battery deployment by battery production location, 2023-2025**

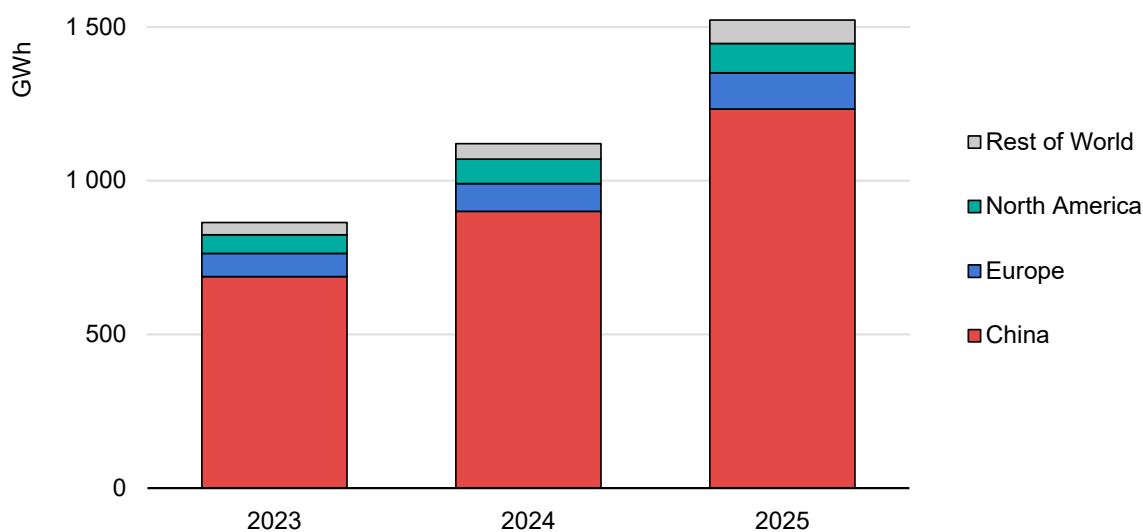

IEA. CC BY 4.0.

Notes: Battery production refers specifically to the manufacture of battery cells. Production refers to the production of batteries that are deployed in a given year.

Sources: IEA analysis based on data from [EV Volumes](#), [Benchmark Mineral Intelligence](#), [CRU](#).

In terms of major market players, however, Chinese, Korean and Japanese producers continue to dominate global production, supplying nearly all battery cells used worldwide. The share of Chinese producers in global electric car battery deployment increased further in 2025, reaching almost 75%. The market share of Chinese producers is growing particularly rapidly in the European Union, where

they accounted for over half of the market in 2025 – almost double their share in 2023. Their presence in Europe reflects a mix of local production – such as CATL’s plant in Germany – and imports.

The United States is the only major market where the share of Chinese producers declined in the past year, standing at just over 5% in 2025. Panasonic, historically Tesla’s battery partner, remained the country’s largest supplier, providing over 40% of the batteries in US-produced electric cars sold globally in 2025. Over recent years Panasonic has lost some market share as Korean manufacturers – including LG Energy Solution, Samsung SDI and SK On – expanded their production footprint across the US market. However, Korean producers are likely to be more exposed to recent downward revisions of automakers’ electrification plans, as much of their US expansion has been built on close strategic partnerships with companies such as [General Motors](#), [Ford](#) and [Stellantis](#), which have recently scaled back their electrification ambitions.

**Figure 7.11 Share of electric car battery sales by battery manufacturer’s headquarters, 2023-2025**

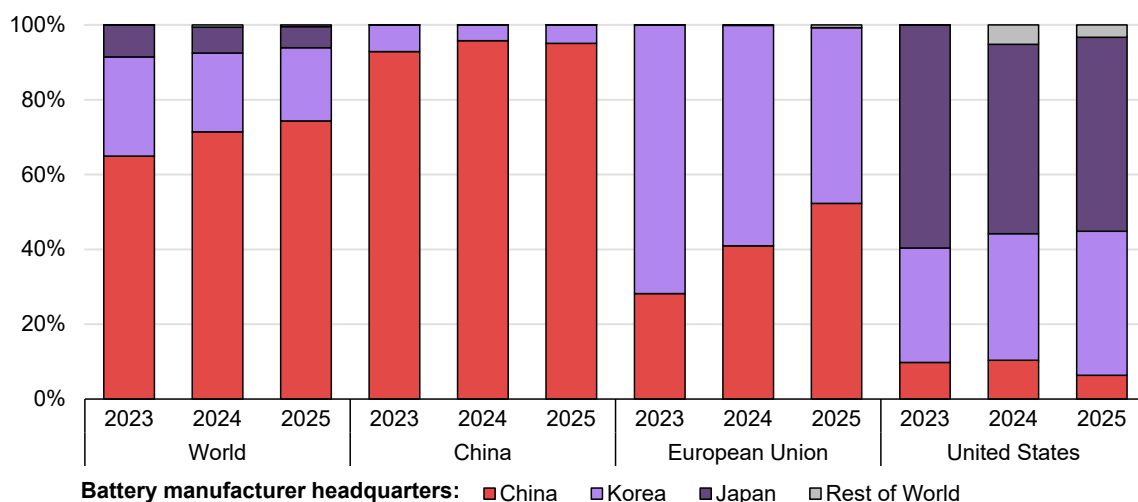

IEA. CC BY 4.0.

Notes: Battery refers to battery cells and reflects the batteries installed in vehicles produced in each region and sold in a given year. Electric car and battery stockpiling are excluded from the analysis.

Sources: IEA analysis based on data from [EV Volumes](#).

New entrants typically need more time to ramp up than established manufacturers with long-standing expertise in advanced battery production and supply chain management. However, even experienced firms face [slower](#) production ramp-up in regions with less mature battery industries, notably because of the lower availability of specialised workforce and production equipment manufacturers to rapidly troubleshoot and resolve production challenges during the ramp-up phase.

Establishing an efficient manufacturing base will be essential for Europe and the United States if they are to meet their ambitions of expanding domestic battery production while delivering affordable EVs.

## Legacy battery form factor choices continue to shape the industry of today

The lithium-ion battery market is divided across three distinct physical configurations, known as “form factors” – cylindrical, pouch, and prismatic cells. Cylindrical cells were the first lithium-ion batteries to be commercialised, introduced in [1991](#) by Sony and benefiting from the maturity of related technologies, notably [alkaline batteries](#), which used this form factor. Japanese manufacturers have since maintained a strong focus on cylindrical cells. Pouch cells enable high energy density and highly customisable dimensions, which helps explain why Korean producers selected this form factor, as their expansion coincided with the rapid growth of the smartphone industry, requiring compact and flexible battery formats. Prismatic cells provide a compact and rigid structure that can be efficiently stacked to maximise space utilisation in EV battery packs, a key reason why Chinese manufacturers – whose growth has been [closely linked](#) to EV deployment – have widely adopted this form factor.

**Figure 7.12 Different battery cell form factors**

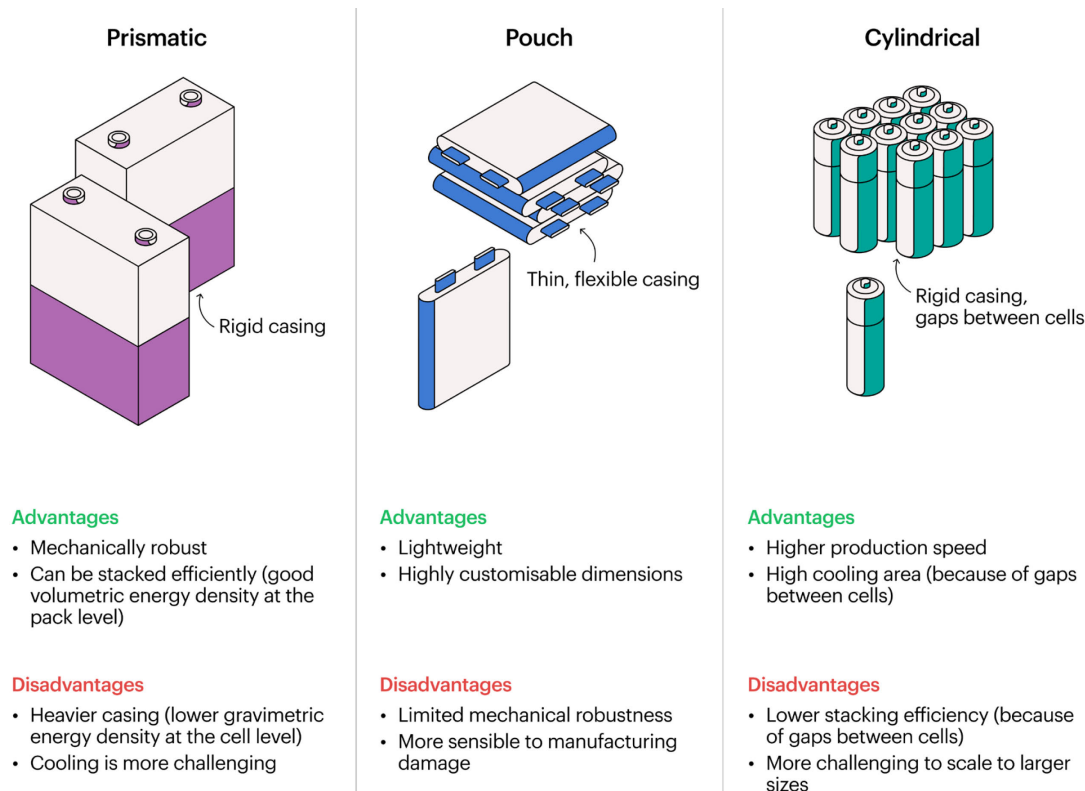

IEA. CC BY 4.0.

Prismatic cells are the most widely used globally today – accounting for over 60% of EV and most stationary storage batteries – largely from Chinese producers. Their performance has improved significantly in recent years thanks to targeted innovations. These include cooling plates used [between](#) prismatic cells to increase the cooling speed, as well as [cell-to-pack](#) (CTP) and [cell-to-chassis](#) (CTC) designs that eliminate the intermediate battery modules and increase overall energy density, albeit introducing additional [complications](#) for recycling. These innovations have been particularly important in enabling the deployment of lithium iron phosphate (LFP) batteries in EVs, which today rely almost exclusively on prismatic cells.

**Figure 7.13 Share of electric car batteries by producer headquarters' location and battery form factor, 2020-2025**

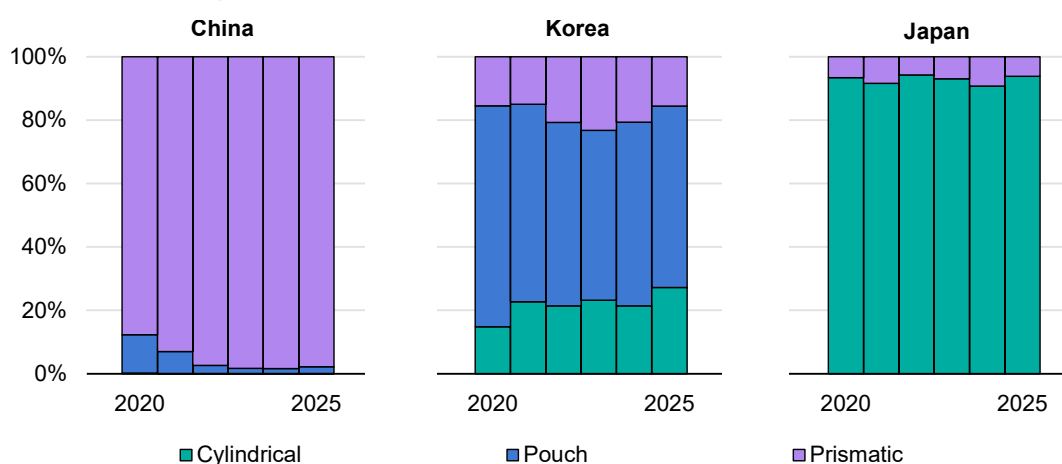

IEA. CC BY 4.0.

Note: China, Korea and Japan refer to the battery manufacturing companies' headquarters, rather than the geographical location of their production facilities.

Source: IEA analysis based on data from [EV Volumes](#).

The legacy form factors established by Japanese, Korean and Chinese battery manufacturers have played a major role in shaping the battery industry over the past decades and continue to influence it today.

The first electric cars powered by lithium-ion batteries, the Nissan [Prairie Joy](#) (1997) and [Altra](#) (1998), as well as the [Tesla Roadster](#) (2008), used cylindrical cells, reflecting the leadership position of Japanese producers at the time. The [Nissan LEAF](#) (2010), the first electric car [exceeding](#) 100 000 sales, used pouch cells, while the [BMW i3](#) (2013) was one of the first notable examples of the use of prismatic cells outside of China.

Although the choice between different form factors depends on several parameters – including energy density needs, battery chemistry and battery pack design – historical partnerships between automakers and battery producers continue to shape global and regional markets. In the United States, cylindrical

cells remain significant, owing largely to Tesla's historical partnership with Panasonic, as do pouch cells from Korean producers. The European market is more evenly split between prismatic and pouch cells, reflecting a market divided between Korean and Chinese battery producers. In China, the market is dominated by domestic manufacturers using prismatic cells.

**Figure 7.14 Electric car battery demand by region of vehicle sale and battery form factor, 2020-2025**

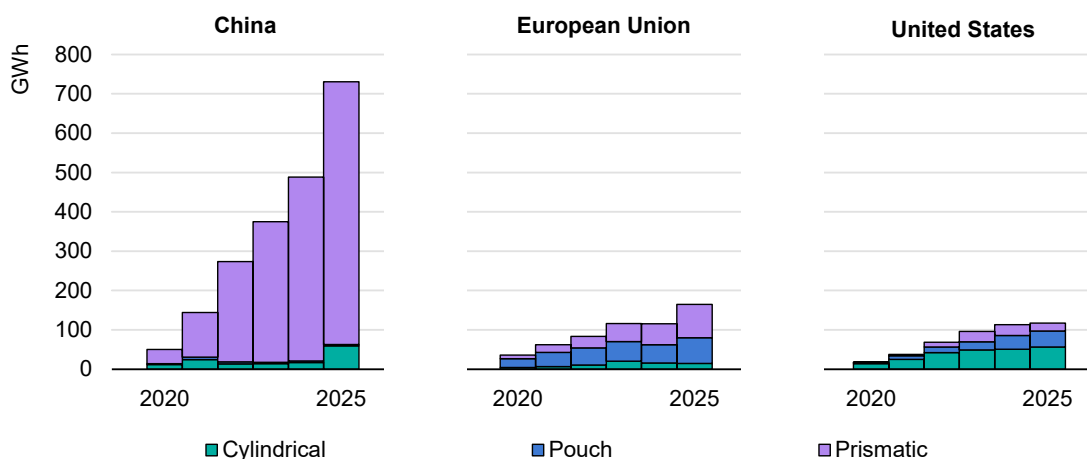

IEA. CC BY 4.0.

Sources: IEA analysis based on country submissions and data from the [European Automobile Manufacturers Association \(ACEA\)](#), [European Alternative Fuels Observatory \(EAFO\)](#), [Marklines](#), [Benchmark Mineral Intelligence](#) and [EV Volumes](#).

## Cathode precursors, LFP and anode materials are the most concentrated steps of the battery supply chain

As batteries become more central to energy systems and the wider economy, strategic risks across their supply chains are becoming more pronounced. Battery factories in Europe and the United States [rely](#) on imports for the majority of their battery components, which come mostly from China, with Korea also playing a significant role as a supplier of lithium nickel manganese cobalt oxide (NMC) cathodes. The lack of investment in midstream supply chains in these markets poses a growing risk to global supply [security](#).

Production capacity and technical expertise for essential components, such as active materials and their precursors, remain heavily concentrated in China. Korea and Japan are the only other countries with historical midstream battery industries, offering opportunities to diversify some component sources. With sufficient investment, emerging markets and developing economies can also play a growing role, supported by lower production costs and, in some cases, access to integrated mineral resources. Indonesia, for example, now has an [anode](#) active material manufacturing pipeline larger than that of Japan or Korea, and its [cathode active](#)

[material \(CAM\)](#) and cathode [precursor](#) industries are also [expanding](#) rapidly. Morocco also attracted significant [investments](#) in LFP [battery](#) and [material](#) production.

The most exposed elements of today’s battery supply chains are LFP batteries, materials and precursors, NMC precursors, and graphite anodes,<sup>33</sup> which are largely reliant on Chinese manufacturing capacity and expertise. When considering only the EV battery chemistries deployed outside China in 2025, almost 80% of batteries used nickel-containing chemistries, such as NMC, and the remainder used LFP, which almost exclusively relies on Chinese supplies.

Cathode precursors – which serve as an intermediate step between refined critical minerals and the final cathode active materials – are particularly exposed to supply disruptions. They enable tighter control over cathode chemistry, particle size and morphology, and impurity levels, all of which are critical factors determining overall battery performance. Processes that produce cathode active materials without using precursors are [being developed](#) and could reduce exposure to highly geographically concentrated supply chains, but they pose greater challenges in ensuring the required consistency in material characteristics and performance.

**Figure 7.15 Share of lithium-ion battery deployment outside China that could be met without supply from China, 2025**

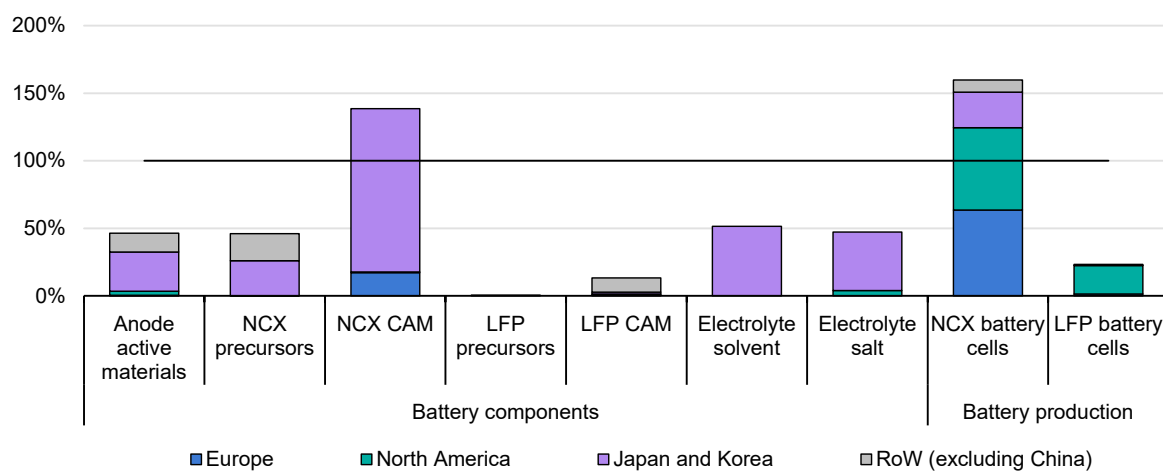

IEA. CC BY 4.0.

Notes: RoW = Rest of World; LFP = lithium iron phosphate; CAM = cathode active material. Colours refer to location of production plants. NCX includes lithium nickel manganese cobalt oxide (NMC) and lithium nickel cobalt aluminium oxide (NCA); 100% refers to global demand excluding China. Bars refer to potential production outside of China if the utilisation rate were to be increased to 85% of nameplate capacity. Lithium-ion battery deployment needs and production capacity refer to electric vehicles and battery energy storage. See [Annex C](#) for more details.

Sources: IEA analysis based on data from [European Automobile Manufacturers Association \(ACEA\)](#), [European Alternative Fuels Observatory \(EAFO\)](#), [Marklines](#), [EV Volumes](#), [Benchmark Mineral Intelligence](#), and [BNEF](#).

<sup>33</sup> The cathode and anode (something also referred to as positive and negative electrodes) store lithium ions, while the electrolyte enables the movement of lithium-ion between the electrodes during battery (dis)charging.

China's [export controls](#) on key battery components introduced in 2023 underscore the vulnerabilities associated with concentrated supply chains. The latest of such export controls, announced in [October 2025](#) and then paused for one year, could have a particularly large impact, as it would expand restrictions over cathode active materials and their precursors, anode materials, LFP components, and advanced chemistries under development, amplifying supply concentration risks. The restrictions would not only affect the export of products, but also of the related production machineries and technologies, which can significantly [hinder](#) countries' efforts to develop diversified battery supply chains.

Reducing the geographical concentration and improving the resilience of the entire battery supply chain requires a substantial increase in investment, alongside stronger international co-operation across the value chain to create sufficiently large markets, backed by stable policy frameworks, to support these investments.

Efforts to diversify the battery supply chain will need to be underpinned by sound economic fundamentals to succeed. Europe and the United States have attracted significant investment in battery cell manufacturing, supported by large automotive industries that offer predictable sources of demand. Similar conditions also apply elsewhere in supply chains: scaling up midstream production capacity requires stable, large-scale demand to justify investment, with a competitive and reliable battery manufacturing base acting as a critical anchor.

However, cost-competitiveness and profitability remain major challenges. Without considering public support measures, battery production costs in Europe and the United States are still as much as 50% [higher](#) than in China – largely because of [higher](#) manufacturing efficiency and automation in China, as well as lower material and component costs. At the same time, battery component markets today suffer from low – in many cases negative – profit margins (see Figure 5.7), effectively hampering new investments needed to diversify the existing supply chains.

Achieving manufacturing efficiencies and automation levels comparable to China will take time and sustained investment. When a new producer begins operations, the share of output that is unfit for sale is often [much higher](#) than is needed to achieve profitability. Competing in today's battery market requires reaching average production yields exceeding 90% and automatising production lines to accelerate throughput and reduce labour intensity per unit of output. For regions without a strong industrial base for battery manufacturing, progress will depend on patient investment, long-term commitment, and partnerships with experienced manufacturers and resource-rich countries.

# Electric vehicle supply equipment manufacturing

## Key components of EV charging infrastructure

As EV deployment grows, attention is also turning to the manufacturing and trade of charging infrastructure equipment. A charging pile typically consists of the following components: power electronics, a control unit, a cooling system, one or more (liquid-cooled) cables, a connector, a user interface and a payment terminal.

**Figure 7.16** Key components of a direct current fast charging pile

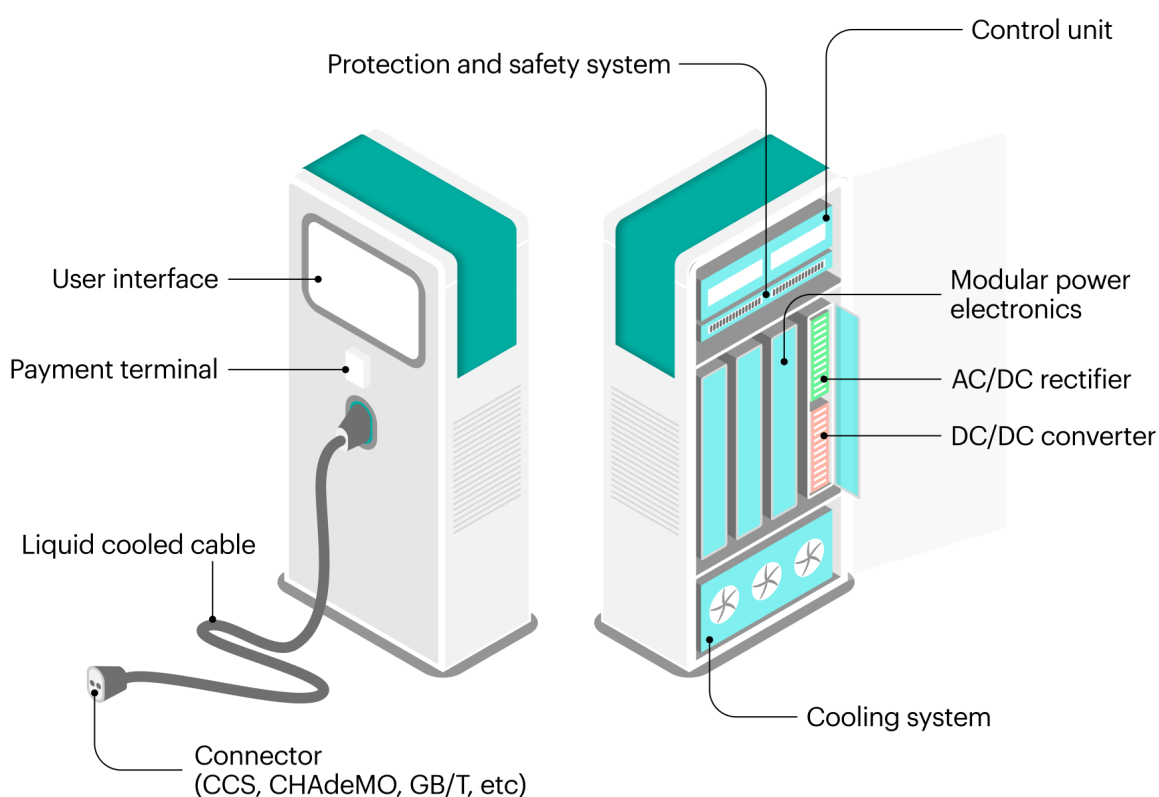

IEA. CC BY 4.0.

Note: AC = alternating current; DC = direct current; CCS = Combined Charging System.

The **power electronics** consist of a large set of [subcomponents](#), which allow the alternating current (AC) supplied by the grid to be converted into direct current (DC). Most slow charging points supply AC to the electric car, simplifying the architecture of the charging point significantly. As EV batteries can only be recharged using DC, vehicles have onboard chargers that perform the conversion when an AC charging system is used. Because the onboard charger must be physically small enough to fit within the vehicle, its power is restricted, so AC charging systems are typically limited to [3.7-22 kW](#), resulting in slower

charging speeds. In contrast, a DC charging station performs the AC-to-DC conversion inside the charging station itself, using large, powerful converters.

The power electronics of a DC charging point consist of an AC/DC rectifier and a DC/DC converter. The converter adjusts (steps up or steps down) the voltage and current to match the requirements of the EV battery during the charging process. This enables precise control and allows the charger to supply a wide range of battery systems, from low-voltage packs to modern 800-1000 V architectures. Both the AC/DC rectifier and the DC/DC converter rely on semiconductor switching devices,<sup>34</sup> such as insulated-gate bipolar transistors (IGBT) or metal-oxide-semiconductor field-effect transistors (MOSFET), to efficiently control and convert electrical power. Many DC charging piles use a modular power electronics architecture. Instead of one large converter, they contain several identical [power modules](#), each providing a certain amount of power.

Power electronics do not always need to be located inside the charging point. In some charging systems, the large AC/DC and DC/DC converters are [installed remotely](#) in dedicated power cabinets, while the charging piles only contain the (liquid-cooled) cable, user interface, and control electronics. This makes it possible to install smaller charging piles in locations with limited space.

The **control unit** is the operational “brain” of a charging pile. It monitors the charging process, manages power distribution and sends updates to the backend network for metering, billing and remote updates of the system. Furthermore, it communicates with the vehicle’s battery management system and – based on signals from the battery – determines the appropriate charging voltage and current. The control unit also manages safety conditions, such as temperature limits, insulation monitoring and fault states, ensuring that charging proceeds safely under all conditions.

To prevent overheating of the sensitive internal components, the pile includes a dedicated [cooling system](#). This system typically uses liquid-cooling loops with heat exchangers or air-cooling systems with fans to remove heat from the power electronics and other critical components. In the case of ultra-fast DC chargers, the charging cable itself is often liquid cooled as well. This allows high charging currents without overheating and enables the use of lighter and more flexible cables. The cable attaches to a region-specific connector such as CCS, CHAdeMO, or NACS.

---

<sup>34</sup> In power electronics, “switching” refers to how semiconductor devices rapidly turn the electrical current on and off in precise patterns. This allows the charger to convert AC to DC and to adjust voltage and current for the EV battery.

## Five manufactures have produced roughly a fifth of charging points deployed to date

The global EV charging equipment market is highly fragmented, with both specialised start-ups and large industrial companies competing across AC and DC charging segments. Together, the five largest charging point manufacturers by volume (Delta Electronics, Star Charge, ABB, Alfen and TELD) represent just over 20% of cumulative charging points sold. In terms of sales volumes, the slow AC charger segment is much larger compared to the DC charger segment, but with prices for home chargers only a fraction of DC fast chargers, the latter segment is responsible for a disproportionate share of total market value.

Although charging hardware is traded internationally and many manufacturers export their equipment, the market remains heavily regionalised. This is due to differing connector standards, certification requirements and policy incentives, which result in chargers being deployed primarily within their region of production. In addition, the electric vehicle supply equipment (EVSE) industry includes companies with very different business models. Some firms act mainly as charge point operators that assemble chargers using externally sourced components, while others are specialised EVSE manufacturers that design and produce key components, including power electronics systems, semiconductors and high-power assemblies.

**Figure 7.17** Distribution of cumulative alternating current and direct current electric vehicle charger sales by manufacturer headquarters region, 2025

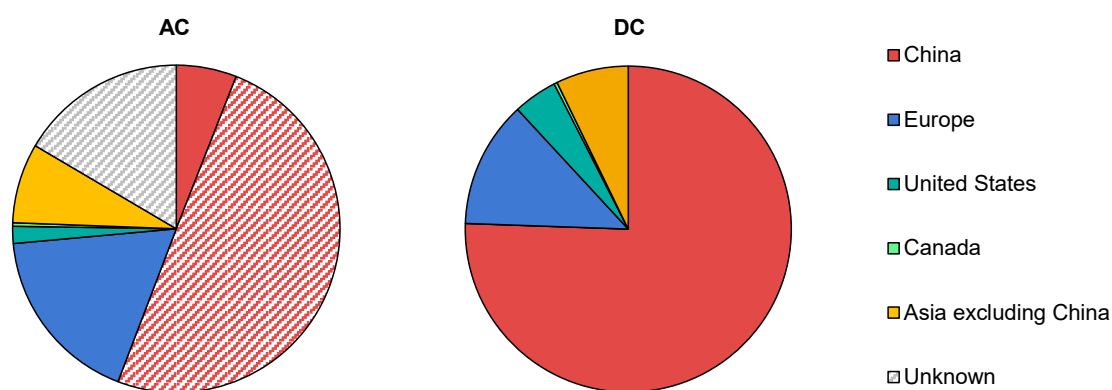

IEA. CC BY 4.0.

Notes: AC = alternating current; DC = direct current. Cumulative sales figures from EVSE manufacturers are based on publicly available company announcements and amount to nearly 15 million charging points. Assuming a charger-to-EV ratio of 0.7, this coverage only accounts for a share of the global installed base of public and private charging equipment. For charging points not captured in the dataset for China, the analysis assumes they are produced by China-headquartered manufacturers. Missing data for other regions are classified as unknown.

Sources: IEA analysis based on data from [BNEF](#), [ABB](#), [Alfen](#), [Alpitronic](#), [BTC](#), [Chargepoint](#), [Compleo](#), [CTEK](#), [PR Newswire](#), [Flo](#), [Hard Hitter](#), [Heliox Energy](#), [Keba](#), [LG](#), [ZeroVA](#), [Pod Energy](#), [Signet](#), [Sinexcel](#), [Starcharge](#), [Tesla](#), [Wallbox](#), [Winline](#) and [Zaptec](#).

In **China**, major EVSE manufacturers include Star Charge and TELD (TGOOD). Star Charge has supplied hardware for more than [2 million](#) charging points including over [700 000](#) public charging piles in China. TELD (TGOOD) has provided hardware for a rapidly expanding national network that reached roughly [800 000](#) public charging piles in 2025, making it the largest operator of public chargers in China. Both Star Charge and TELD combine EVSE manufacturing with network operation. Besides manufacturers that combine hardware and charging services, automakers such as BYD, Xpeng and NIO also manufacture their own charging equipment, primarily targeting DC fast chargers.

In **Europe**, the leading DC charging equipment manufacturers are ABB E-mobility (Switzerland) and Alpitronic (Italy). Both companies have scaled significantly and now support large bases of DC fast chargers, and each delivered over [5.5 TWh](#) of electricity as of Q1 2026. In total, around [75 000](#) ABB DC chargers and [120 000](#) Alpitronic DC chargers are installed. Their production capacity is also increasing. ABB's Italian facility reached an output of [1 DC charger every 20 min](#) (equating to roughly 6 500 annually, or around 30% of EU ultra-fast charging point additions in 2025). ABB has additionally opened a factory in the United States capable of producing up to [10 000 chargers](#) per year. Alpitronic has also been expanding internationally, reaching a [12% market share](#) in the United States in 2025. Both companies design and assemble the main power electronics system, but source key semiconductor components, such as IGBTs and silicon-carbide (SiC) modules, from specialised suppliers. In the European Union, new installations deployed after April 2024 must comply with [AFIR requirements](#), including the obligation for DC fast chargers to provide a built-in payment terminal supporting common payment methods. For charging points with power below 50 kW, alternative secure payment methods are permitted, for example via a QR code that leads to the payment webpage.

In the **United States**, the main EVSE manufacturers are Tesla and ChargePoint. Tesla produces its own charging hardware and operates its proprietary charging network of over [80 000](#) charging points globally, including over [37 000](#) within the United States. ChargePoint both manufactures chargers and operates one of the largest charging networks in the country, with [25 000](#) stations. Similarly, Blink combines manufacturing and operating with [1 800](#) public fast chargers.

US federal policy is increasingly focused on reinforcing domestic EVSE production. Since July 2024, chargers supported by federal funding under the National Electric Vehicle Infrastructure funding programme must be assembled domestically and must incorporate more than [55% US-manufactured components](#). Against this backdrop, Tesla's Gigafactory in New York produced more than [15 000 V3 Supercharger](#) power cabinets between 2019 and the start of 2026. Each of these cabinets can supply power to up to four individual charging stalls, enabling more than 60 000 V3 stalls globally. Other manufacturers headquartered

in the United States, such as Blink, have expanded their domestic EVSE production and Blink announced in 2024 the aim to increase production capacity to [50 000 chargers](#) per year.

In early 2026, the Federal Highway Administration proposed strengthening these requirements by mandating that all federally funded chargers use [100% US-sourced materials](#), including metals, wiring and electronic components. These requirements are seen by some manufacturers (e.g. [Alpitronic](#) and [Delta Electronics](#)) as difficult to fulfil, due to limited domestic capacity to produce components such as cables, display screens and payment terminals.

## Dynamic power management in chargers will increase scalability for the future

Within the DC fast charging segment, there is an ongoing shift in the design of charging piles and stations towards more modular and flexible architectures. Earlier generations of DC fast chargers typically relied on fixed or semi-fixed power allocation per charging point (e.g. 150 kW per stall), often reserving capacity regardless of how much power the connected vehicle could actually accept. Manufacturers are now increasingly deploying chargers built with modular power modules combined with [dynamic power management](#), allowing available capacity to be shared in real time based on vehicle demand and charging curves.

In a typical configuration, a charger rated at 400 kW may consist of four independent 100 kW power modules that can be paralleled and dynamically assigned. When charging a single vehicle, it may draw the full 400 kW if compatible, and when charging two or more vehicles simultaneously the vehicles can receive power in proportion or according to priority rules set by the charging management system. This dynamic power sharing improves utilisation of installed capacity and enables smoother load profiles compared with fixed-allocation designs. Flexibility can be further extended through centralised power cabinet architectures, in which power modules are placed in a shared cabinet and connected to multiple dispensers or piles. The parallelisation of power modules also helps manufacturers to reach higher power levels.

EVSE technology is rapidly progressing toward higher charging powers, driven by the electrification of heavy-duty vehicles and the increasing fast charging capability of new electric car models ([Chapter 8](#)). Scaling charging power to megawatt level requires charging infrastructure that goes beyond today's mainstream power modules and cooling systems, and designs able to sustain higher loads. In 2025 several manufacturers started to introduce 600 kW to 1.5 MW chargers. In Europe, [ABB](#), [Alpitronic](#) and [Kempower](#) all launched megawatt charging systems. In China, four manufacturers announced megawatt charger models: [BYD](#), [Huawei](#), [Didi](#) and [Zeekr](#).

The shift towards higher charging power requires vehicles and charging infrastructures compatible with higher voltage architectures, such as in the 800-1 000 V range ([Chapter 8](#)). This transition also requires a shift from conventional silicon-based semiconductors towards electronic components made from alternative materials, such as [silicon-carbide](#) (SiC) and [gallium-nitride](#) (GaN), that are better suited to operate at higher voltages and power levels.

# Chapter 8. Technology trends

## Overview

### Key technology trends are aligning in favour of EVs

Electric vehicles (EVs) are increasingly at the centre of innovation in the automotive sector, bringing advances that extend far beyond developments in batteries and power electronics, thanks to several mutually reinforcing factors.





Battery electric vehicles (BEVs) are mechanically simpler than internal combustion engine vehicles (ICEVs) or hybrids, making them more compatible with digitalisation and automation. The relative simplicity of electric drivetrains enables shorter development cycles for new vehicles, allowing emerging technologies to reach BEVs sooner than vehicles with other powertrains.

While the transition from mechanical to software-based vehicle control has been underway for decades, it has accelerated dramatically with the rise of EVs. Pure-play EV makers have pioneered the shift towards high-level, continuously updateable software-based vehicle control, speeding up the development and rollout of new features. Vehicles are evolving into software platforms for which users can access subscription-based premium features, in the same way as for smartphones.

Linked to these factors, progress in AI and computing power is disproportionately benefiting EVs, particularly for automated driving and integrated vehicle control. Sensors and chips integrate well with the stable, high-voltage power supply of EV batteries. At the same time, the benefits of AI and increased computing power are not exclusive to EVs. [AI-enabled energy management](#) systems are increasingly used to optimise hybrid vehicles, and AI techniques are [accelerating](#) the design, testing and optimisation of all vehicles.

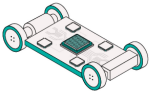
Finally, technologies enabling EV-grid integration are becoming increasingly available, allowing EVs to play a larger role in the energy system and improving their value proposition. With the rollout of smart and bidirectional charging, EV owners can reduce charging costs and, in some cases, generate revenue by participating in grid services, such as frequency regulation. Load shifting and vehicle-to-grid (V2G) capabilities provide substantial electricity system benefits, helping reduce peak demand and potentially limiting the need for future grid investment – benefits for which EV owners can be compensated.

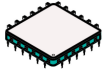
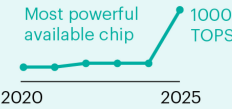
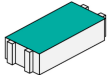
**Table 8.1 Key technological trends in the automotive industry and beyond that favour electric vehicles**

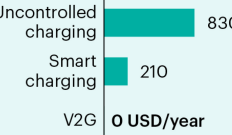
<p><b>Software-defined vehicles</b></p> 	<p><b>What's happening?</b> A new design paradigm is emerging: zonal and centralised control architecture with over-the-air updates.</p>	<p><b>Why does it favour EVs?</b> EVs have fewer mechanical dependencies, facilitating centralised software control.  Software-native pure-play EV makers have spearheaded this trend.</p>	<p>Over <b>90% of OEMs</b> are committed to transitioning to <b>zonal architectures</b>.  <b>100%</b> of current models with zonal architecture and near full over-the-air updates are <b>battery electric</b>.</p>
<p><b>ADAS and autonomous vehicles</b></p> 	<p><b>What's happening?</b> ADAS features have become mainstream and of strategic importance to automakers.  Commercial robotaxi services are starting to scale up.  Autonomous trucks are approaching commercialisation.</p>	<p><b>Why does it favour EVs?</b> Built-in high voltage batteries support sensors and chips.  ADAS and autonomous features integrate well with SDV architectures.  Autonomous fleet operators value the lower running costs of EVs.</p>	<p><b>100% of current robotaxis</b> are battery electric.  EVs sold in 2025 were almost <b>2x more likely</b> to have partial automation features than ICEs and hybrids.</p> 
<p><b>Progress in computing chips and AI</b></p> 	<p><b>What's happening?</b> Chips are becoming more powerful, specialised and energy-efficient.  AI models are becoming larger (parameters, data) and more powerful.</p>	<p><b>Why does it favour EVs?</b> Advances in chips and AI augment capabilities of SDVs and AVs.  AI can improve battery management systems and co-ordinated EV charging.</p>	<p>Automated driving chips have become <b>5x more powerful</b>.</p> 
<p><b>Progress in batteries and power electronics</b></p> 	<p><b>What's happening?</b> Batteries are rapidly improving and getting cheaper.  Improved battery technology and new materials for power electronics (SiC, GaN), enable higher voltages, increasing charging efficiency and speed.</p>	<p><b>Why does it favour EVs?</b> The price gap between EVs and ICEVs is narrowing in many markets.  Ultra-fast charging can reach similar speeds as refuelling a car with gasoline.</p>	<p>Battery pack prices <b>-75%</b> and <b>energy density +60%</b> over the last 10 years.  Over <b>30 new models</b> with <b>high-voltage</b> architecture released in 2025.</p>
<p><b>Energy system integration</b></p> 	<p><b>What's happening?</b> Electricity demand is growing strongly, with EVs contributing more and more to this growth.  Intermittent renewables increasingly supply low-cost electricity.</p>	<p><b>Why does it favour EVs?</b> EVs can offer benefits to the grid via smart charging and by providing grid services through V2G capabilities.  Supporting the grid can improve the value proposition of EVs.</p>	<p>First commercial V2G tariffs offer <b>free home charging</b>.</p> 

Notes: ADAS = advanced driver assistance system; AI = artificial intelligence; SDV = software-defined vehicle; EV = electric vehicle; ICEV = internal combustion engine vehicle; AV = autonomous vehicle; SiC = silicon carbide; GaN = gallium nitride; V2G = vehicle-to-grid; OEM = original equipment manufacturer; TOPS = Trillion Operations Per Second. Sources: IEA analysis based on data from [IOT analytics](#), Bloomberg NEF; charging costs for V2G tariff taken from [Octopus](#).

# Vehicle software and software-defined vehicles

## A new design paradigm is emerging, with EVs at the forefront

The digital transformation of the car industry is most evident in the [emergence](#) of software-defined vehicles (SDVs), in which software determines an increasing share of vehicle functionality. This shift is not based on software alone, but also on a re-imagining of the electronic and electrical architecture of vehicles over the past decade, pioneered by pure-play EV makers. In conventional distributed architectures, each function – such as lighting, braking or climate control – is managed by its own dedicated controller, or electronic control unit (ECU). This is now giving way to domain or “zonal” architectures, with a smaller number of ECUs controlled by central computers.

**Figure 8.1 Key design differences between conventional and software-defined vehicles**

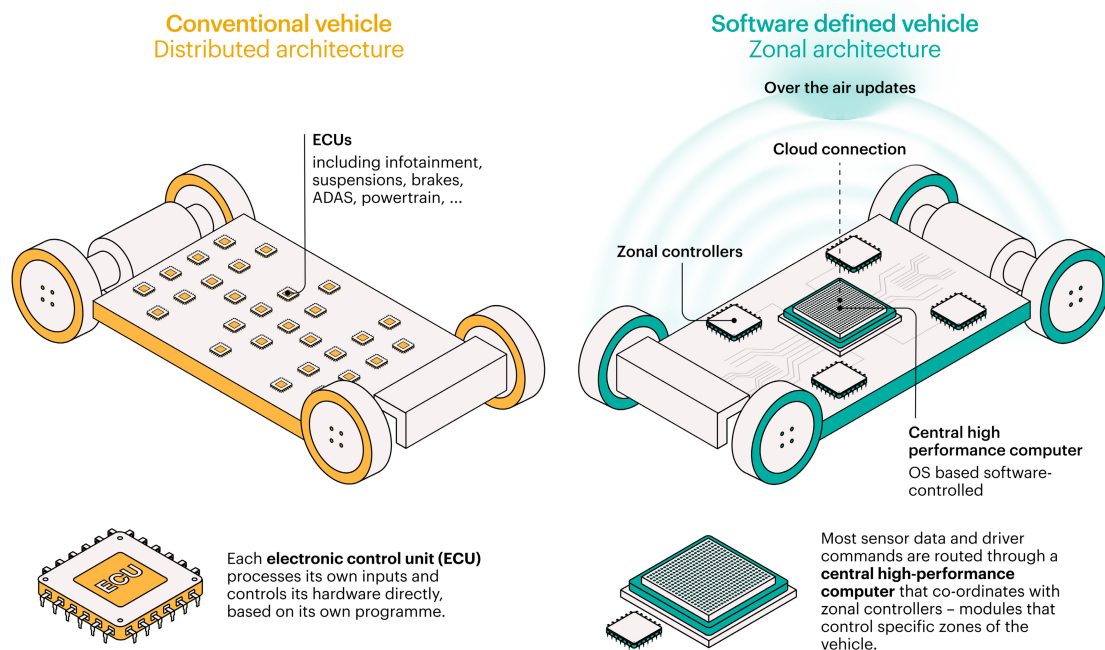

IEA. CC BY 4.0

This shift reduces wiring complexity and enables a greater share of vehicle functionality to be defined and updated through software, and expanded over

time.<sup>35</sup> As a result, critical functions such as advanced driver assistance systems (ADAS) and battery management systems can be improved through over-the-air (OTA) updates. Manufacturers can also deploy new features, performance improvements and security updates more rapidly across a vehicle's lifetime. When combined with the lower material requirements of zonal architectures compared with distributed designs, these benefits can reduce EV production costs, provided volumes are sufficient to spread development [costs](#) across enough vehicles.

Lower vehicle production costs can translate into lower purchase prices for consumers, but an [increasing number of features](#) in base models and greater reliance on subscription-based functions could also increase costs for users, albeit creating a new revenue stream for manufacturers. For example, "feature-as-a-service" business models – through which users can access premium vehicle functions through one-off payments, subscriptions or pay-per-use arrangements – offer greater flexibility but may also raise lifetime costs depending on automaker strategies and consumer choices.

At the same time, software – particularly over-the-air updates – can support affordability by ensuring the vehicle remains up to date for longer. [First introduced](#) by Tesla in 2012, OTA updates enable software and firmware upgrades delivered via wireless connectivity, without requiring a visit to a dealership or service centre. OTA capabilities enable manufacturers to fix software defects, improve vehicle performance, tune vehicle functionality, deploy cybersecurity patches and introduce new features after the initial sale.

While most major automakers have plans to develop these software-defined systems across different powertrains, all currently available models with zonal architectures and extensive OTA capabilities are battery electric – primarily from pure-play EV manufacturers. Additionally, while conventional vehicles and SDVs represent two ends of a technological spectrum, many automakers are currently deploying architectures that fall between them. These intermediate systems consolidate some functions into shared computing units but retain dedicated controllers for safety-critical or legacy systems. This gradual approach allows manufacturers to expand software capabilities and enable additional features at the same time as managing development costs and timelines associated with the required vehicle and production platform redesigns.

---

<sup>35</sup> More centralised architectures facilitate the abstraction of vehicle functionality into centralised software layers. Software abstraction simplifies complex systems so that the end user is not faced with unnecessary details, while allowing developers to work at a high level to efficiently maintain and update the software.

**Figure 8.2** Number of models and original equipment manufacturers offering zonal architecture and near-full over-the-air update capability

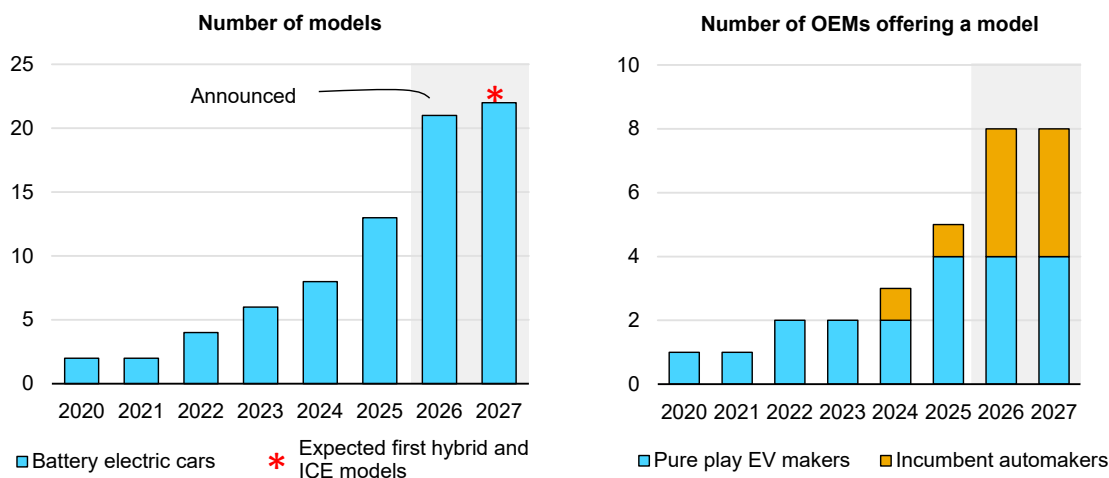

IEA. CC BY 4.0

Notes: Zonal architecture refers to a centralised electrical/electronic layout where a few powerful computers control diverse systems. Near-full over-the-air update capability is defined as the ability to remotely update almost all vehicle software components, including powertrain control, battery management systems and advanced driver assistance systems (ADAS). Sources: IEA analysis based on OEM product statements and press releases.

## The rise of software is reshaping development processes and industrial partnerships

Software development requires a fundamentally [different approach](#) to traditional automotive engineering. In conventional vehicle development, specifications are typically defined early in the design process. In contrast, software development relies on iterative cycles in which a set of features is introduced early on, followed by multiple rounds of updates for bug fixes and additional functionality. This shift can create [advantages](#) for new entrants structured around a software-first model and for incumbent manufacturers that succeed in adapting their processes, but it poses a challenge to companies that do not.

The role of electronics in cars has been growing ever since the 1970s, steadily expanding vehicle functionalities. A significant turning point occurred in [2017](#), when Tesla shifted from a distributed electrical and electronic architecture to a centralised, software-defined approach.

However, successfully transitioning from a historically hardware-centred business model to software-defined vehicles is neither quick nor cheap. In [2023](#), Volkswagen [scaled back](#) its ambition to develop core vehicle software entirely in-house through its own software company, CARIAD. Instead, it shifted towards partnership-based models, including the establishment of a [joint venture](#) with Rivian. Similarly, Ford decided to [abandon](#) its “fully networked vehicle” project in

2025. Other incumbent automakers are, however, shifting more smoothly towards software-centred vehicles, such as [BMW](#) and [Mercedes-Benz](#).

**Figure 8.3 Evolution of control layers and technologies in cars over time**

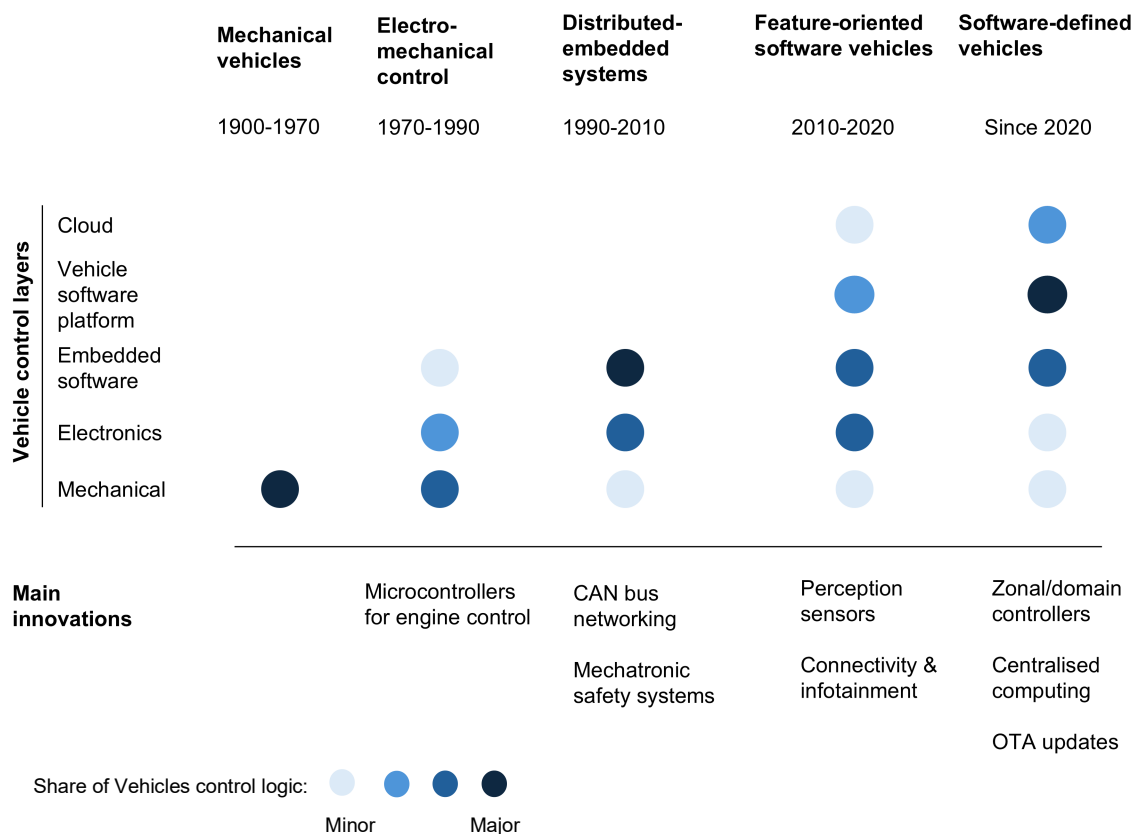

IEA. CC BY 4.0

Notes: CAN = controller area network, OTA = over-the-air.

The increasing software content of vehicles is also reshaping the role of operating systems. A growing number of automakers are adopting automotive-grade operating systems derived from consumer technology ecosystems, such as [Android Automotive OS](#), to support infotainment, navigation and app-based services. This trend can lower development costs and accelerate feature deployment, but it raises [strategic questions](#) around dependency on large technology providers, data governance and long-term control over the in-vehicle user interface.

Automakers are adopting a range of strategies to strengthen their software capabilities. Companies such as [Tesla](#), [Toyota](#), and [BYD](#) emphasise in-house development to retain control over key vehicle functions and data. Others have established dedicated partnerships, such as [General Motors and NVIDIA](#), or [Renault and Google](#), software subsidiaries like [BMW Car IT](#), or an in-house software platform such as General Motors Ultifi.

# Autonomous vehicles

## Electric vehicles lead in automation and advanced driver assistance

Driving automation is at the forefront of software developments for cars today. While fully autonomous cars (Level 5 automation, see Table 8.2) are not currently in sight, electric driverless taxis (Level 4) are already operating commercially in more than 20 cities worldwide. Moreover, automated driving systems are not limited to self-driving cars – they are also rapidly gaining importance in the form of ADAS for private vehicles.

EVs are more frequently equipped with ADAS features, and all commercial robotaxi services in operation today exclusively use EVs. High-voltage batteries, reduced mechanical complexity, and precise torque control support the integration of automation systems with BEVs. ADAS and autonomous systems rely on extensive data collection and continuous software refinement – an area where digital-first architectures, pioneered by EV makers, provide a clear edge. The mutually reinforcing trends of software-defined vehicles and automated driving are therefore consolidating the technological leadership of EVs.

**Table 8.2** Different levels of driving automation

	Level	Description	Sample features	Hands off	Eyes off	Mind off
Assisted	<b>0</b> Manual	Driver retains all driving tasks	Automatic emergency braking, lane departure warning	●	●	●
	<b>1</b> Assisted driving	Steering or speed control by the system	Adaptive cruise control (ACC), lane-keeping assist system (LKAS)	●	●	●
	<b>2</b> Partially automated driving	Steering and speed control by the system	Coupled ACC & LKAS	●	●	●
	<b>2+</b> Advanced partially automated driving	Hands-off but driver must immediately take control whenever requested	Navigation on autopilot	●	●	●
Automated	<b>3</b> Automated driving under conditions	System drives under pre-defined conditions; driver needs to step in within ~10 seconds upon system request	Traffic jam pilot, valet parking	●	●	●

	Level	Description	Sample features	Hands off	Eyes off	Mind off
Autonomous	4 Autonomous driving under certain conditions	System drives under pre-defined conditions; no take-over required	Autonomous driving in approved zones	●	●	●
	5 Autonomous driving in all conditions	System drives in all conditions; no take-over required	Autonomous driving everywhere	●	●	●

Sources: Adapted from World Economic Forum (2025), [Autonomous Vehicles: Timeline and Roadmap Ahead](#), based on definitions in [SAE International Standard J3016 \(2014\)](#).

## Partially automated driving is becoming mainstream while autonomous vehicles are starting to gain traction

Over the past 10 years, ADAS have become much more widespread. In 2025, [around half](#) of new cars sold globally featured systems that can automate steering and speed control (Level 2 automation), whereas 10 years earlier this was limited to very few high-end models, accounting [for less than 1%](#) of sales. However, the most commonly deployed systems, like adaptive cruise control combined with lane-keeping assist, require the driver to have their hands on the steering wheel, and only function under certain conditions, mainly on highways.

Further development of ADAS is amongst the [top strategic priorities](#) of OEMs today. Beyond [compliance with regulations](#) and increasing road safety, OEMs see driving automation as one of the main competitive differentiators, with high potential to unlock new revenue streams. The most advanced Level 2 systems in private passenger cars today allow for hands-free navigation on autopilot (Level 2+). People's Republic of China (hereafter, "China") and the United States are adopting these systems most quickly; [10% and 6%](#), respectively, of cars sold in 2025 in these countries were equipped with Level 2+ technology. In the United States, Level 2+ ADAS are either sold as [premium features](#) or via [software subscription services](#), whereas in China they are often [included in base models](#). With these systems, drivers are still required to be ready to instantly take full control over the vehicle whenever requested.

Applications of Level 3 systems, in which the legal responsibility shifts to the manufacturer while the system is active, are still very rare. In 2021, Mercedes-Benz was the first manufacturer to offer a Level 3 system: its Drive Pilot system was made available as a [subscription service](#) in two high-end models, one of them battery electric. The [system permits](#) autonomous driving in dense traffic and good weather conditions at speeds up to 95 km/h on motorways in parts of Germany and the United States. Drivers can take their eyes off the road but must be ready to retake control of the vehicle with 10 seconds warning. Level 3 systems have a

much higher need for redundancy, driving up cost. Furthermore, regulations and certification for Level 3 systems differ by country, complicating widespread deployment. Notably, Mercedes-Benz decided to [no longer offer](#) their Level 3 system in their latest model update in early 2026, instead offering Level 2+ systems with wider application. BMW is reportedly also [planning to discontinue](#) its Level 3 system. This is in line with a [wider industry shift](#) away from developing Level 3 systems to integrating more sophisticated Level 2+ functionality for personal vehicles. In China, however, interest is still growing, with the first local [permits for two models](#) with Level 3 systems granted in 2025.

Driverless vehicles have now become a common sight in multiple cities in the United States and China, in the form of robotaxis. Such Level 4 systems avoid the [handover](#) of responsibility while driving and legal grey zones which currently inhibit Level 3 deployment. Robotaxis operate within a geolocalised domain, such as a single city, and are deployed as centralised fleets, allowing companies to continuously monitor, analyse and improve functionality through software updates. Autonomous trucks are also gathering momentum, with the first early commercial deployments in the United States and China. Both robotaxis and autonomous trucks offer large potential for efficiency gains and cost savings, but ensuring reliability under all conditions and complying with regionally diverse regulations remain challenging.

### The global fleet of robotaxis is all electric and deployment is accelerating

Today, all robotaxis are BEVs, due both to their technical characteristics and cost advantages. First, operating costs are lower for electric cars, which is an important consideration for intensively used taxis. Second, software control of EVs is more mature than for ICEVs and hybrids. This can be partly explained by the lower mechanical complexity of electric cars, and partly by the recent push for centralised architectures and SDVs led by pure-play EV makers (see above). Third, battery electric cars comply with emissions standards in cities. Finally, power draw for [onboard computation](#) and sensors needs to be [very stable](#) and can be substantial – estimates span from [several hundred watts](#) to over [1 kW](#) – which can be more easily accommodated by EV batteries and power electronics.

Robotaxi deployment saw record growth in 2025. Following several years of commercial pilots, the robotaxi fleet more than doubled to reach 8 000 vehicles spread across around 20 cities globally. Commercial services today are concentrated in China and the United States, though [Dubai and Abu Dhabi](#) also have commercial robotaxis on the road. Testing of autonomous taxis has begun in Europe, Japan and Korea.

So far, robotaxi services have been offered by only a few companies, but competition is set to increase over the coming years. Commercial robotaxi services were [dominated](#) in 2025 by Waymo in the United States and by Baidu, WeRide and Pony.AI in China. All these companies have plans to expand to more cities and countries. Meanwhile, companies offering ride-hailing services, such as Uber, Lyft and Bolt, have formed partnerships with various developers of self-driving technology, though are not yet offering commercial services. Many of these partnerships [target launch in 2026](#) and 2027, which will significantly increase the number of players in the market. While car makers such as Volkswagen and Nissan are now developing their own robotaxi models, some pure-play EV makers, such as [Tesla](#) and [Xpeng](#), are intensifying R&D efforts on autonomous driving by developing their own chips and AI models.

While early robotaxis were built on existing EV models, the focus is increasingly shifting toward [purpose-built](#), software-defined vehicle architectures in which autonomous driving capabilities are integrated at the design stage.

**Figure 8.4** Number of cities with commercial robotaxi services and number of pre-commercial robotaxi projects, 2020-2026

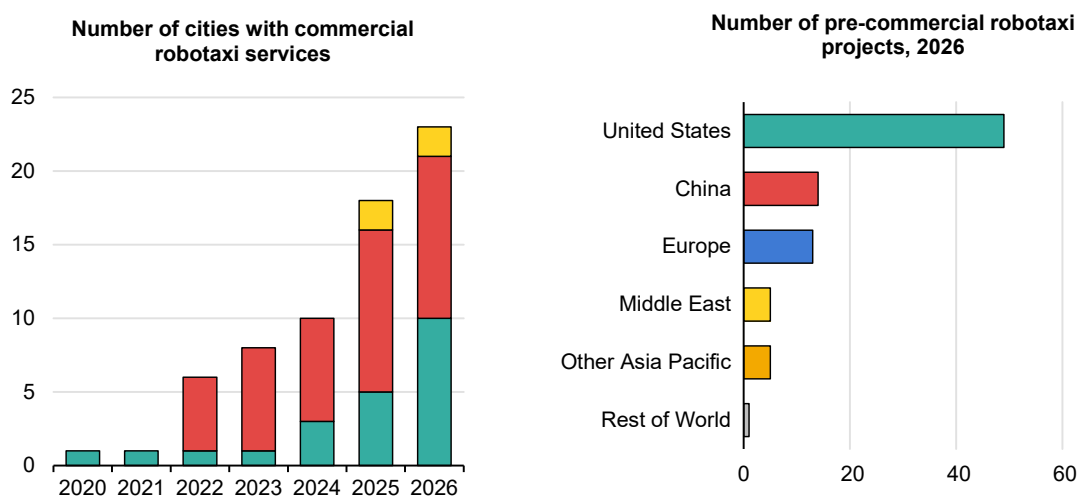

IEA. CC BY 4.0

Notes: 2026 numbers are as of March 2026. Commercial robotaxi services comprise those in which services are publicly available for a fee, without a safety driver needing to be present.

Source: IEA analysis based on Bloomberg Self-Driving Vehicle Tracker.

## Technology cost reductions will drive electric robotaxi adoption

Using a self-driving taxi is currently more expensive than other ride-hailing services both in the United States and China, but the [price gap has narrowed](#). The cost structure underlying robotaxi services differs markedly from other ride-hailing services. Whereas the main cost-component in standard taxi services is the driver,

accounting for [over 50%](#) of total costs, robotaxis have significantly [higher upfront costs](#) for sensors and computer hardware, as well as a need for increased maintenance and vehicle control centres.

Costs for robotaxis have declined significantly over the past few years. Current designs employ fewer sensors than the first models, and the costs of electric cars, batteries and sensors have also fallen at the same time. For example, the first robotaxi to enter commercial operation, Waymo's Jaguar I-Pace, used 40 sensors and cost more than USD 100 000. Waymo has since [reduced](#) the number of sensors and diversified to [cheaper EV models](#), and thus reduced vehicle cost to around USD 70 000. Baidu announced in 2025 that manufacturing costs for the Apollo RT6 self-driving car had been reduced to [under USD 30 000](#), benefiting from [drastic cost reductions](#) for lidars<sup>36</sup> in China. Tesla is targeting similarly low costs for their robotaxis by relying [solely on cameras](#), but has not yet gained Level 4 approval.

Despite their higher costs, robotaxis have started to compete with other ride-hailing services in some cities. However, due to discounts on fares and substantial R&D costs, companies offering self-driving services are mostly not yet profitable. In general, R&D investments needed to bring a robotaxi to the market are currently of the order of [USD 6 billion](#), with the development of self-driving software accounting for the largest share. Further, starting up operations in a new city can cost up to [USD 30 million](#) and take 1-2 years, accounting for infrastructure set-up, regulatory approval, digital mapping and fleet testing. Waymo is [operating at losses](#) of several billion USD but secured another [USD 16 billion funding](#) round in early 2026. Baidu claimed to have reached [profitability of operations](#) in Wuhan for the first time in 2025, due to high local coverage and low vehicle cost. With falling costs for sensors and chips, and economies of scale in fleet management expected over the coming years, the business proposition should further improve.

Driverless taxis will expand into more neighbourhoods, cities and countries over the next decade. The pace of scale-up is, however, slowed by significant costs and the need for city-by-city testing and approval, as well as fragmented regulation and customer acceptance. Estimates of global robotaxi fleet size in 2035 range from [700 000 to 3 million vehicles](#), which are likely to remain concentrated in [40 to 80 cities](#) globally. While this would constitute only a small fraction of the global taxi and ride-hailing fleet, robotaxis could claim most of the ride-hailing market in hot spots. For example, in San Francisco, Waymo has risen to the second most-used ride-hailing service, [overtaking Lyft's market share](#) in 2025. Future

---

<sup>36</sup> Lidar stands for "light detection and ranging". This technology uses lasers to measure distances from surrounding objects.

[cost-competitiveness](#) with private car ownership is still uncertain, meaning that impacts beyond the ride-hailing sector are not likely to materialise before 2035.

## Autonomous driving could revolutionise heavy-duty transport

There is an even clearer business case for autonomous freight transport, especially in regions with high wages or driver shortages. Autonomous trucks do not require resting periods, increasing logistics efficiency, and lowering the total cost of ownership. Self-driving on highways is also more mature than navigating through dense cities. Routes are also often more predictable, allowing services to narrow their operational domain. An additional challenge compared to passenger transport is the integration into logistics operations. Whereas passengers enter and exit the vehicle by themselves, autonomous trucking and logistics need to consider loading and unloading of vehicles and further integration into supply chains.

The first autonomous trucks on public roads [began commercial operation](#) in the United States in 2025. Other early commercial deployments are also underway in [China](#), [Europe](#) and elsewhere in the [United States](#), covering various applications from local delivery services to long-haul trucking. Hub-to-hub logistics are likely to be the first application in which autonomous operations could have a big impact. It has been estimated that up to [one-quarter of truck sales](#) for hub-to-hub logistics could be autonomous in the United States, Europe and China by 2035. By contrast, technical and regulatory hurdles increase with higher complexity and variability of routes, such as in point-to-point services and in urban distribution, which is likely to limit deployment over the next decade.

While many pilots and early deployments of autonomous trucks use traditional diesel engines, there are clear synergies between electrification and autonomy. For electric trucks, autonomous operations can increase utilisation by avoiding driver rest periods, amplifying the effect of lower running costs of electric trucks, due to lower fuel costs. This can significantly shorten the payback period for the higher upfront costs of electric trucks. To fully capture these utilisation benefits, however, autonomous electric trucks must minimise downtime, and charging time becomes the key constraint. Innovative charging solutions such as battery-swapping, MW-scale chargers or inductive charging pads placed at warehouses where trucks load and unload could therefore support the automation of electric freight trucks.

# Artificial intelligence and EVs

## Advances in AI underpin progress in autonomous vehicles

Just two decades ago, state-of-the-art autonomous vehicles were confined to [test tracks](#), and while they already employed a wide array of sensors, the software was limited to rule-based and physics-driven methods. These methods are nearly impossible to generalise to real-world complexity. Machine learning algorithms, on the other hand, can leverage vast amounts of data to optimise driving performance and safety under real-world complexity. Computational power (exploiting [graphical processing](#) units [GPUs]) and AI algorithms (e.g. [image recognition](#), [transformer architecture](#)) has seen rapid advances over the past two decades, making it possible to train neural networks which can handle very complex tasks such as autonomous driving today.

Autonomous vehicles typically employ a variety of sensors, such as cameras, radars and lidars, providing a 360° view of the surrounding environment. AI-powered perception allows for accurate processing of large amounts of sensor data. AI algorithms are used to detect objects, as well as to create a coherent model of the environment using all available sensor data, and to make predictions about where objects will move next. Compared to humans, this allows for a more exhaustive view of the vehicle's surroundings, which has been shown effective at avoiding accidents in [common driving situations](#). However, difficulties remain in handling [rare or ambiguous situations](#), which are not represented in training datasets. These can include extreme weather, rare objects, unexpected behaviour by other road users, and sensor malfunction. Handling of such cases is among the main R&D efforts for autonomous vehicle developers.

End-to-end AI approaches to autonomous driving could [reduce costs](#) and accelerate scale-up but are currently limited by regulatory and safety concerns. By integrating functions from perception to planning within a single model, these approaches have the potential to simplify development and deliver performance gains. However, ensuring safe and predictable behaviour is difficult: rare or unseen scenarios not captured in the training data can lead to unpredictable or unsafe actions, making certification highly complex. Today's robotaxis employ modular approaches in which the planning of driving actions is still mostly rule-based and thus easier to certify. As such, end-to-end approaches are likely to be largely [confined to Level 2+](#) systems over the coming years.

**Figure 8.5 Different uses of artificial intelligence for autonomous driving**

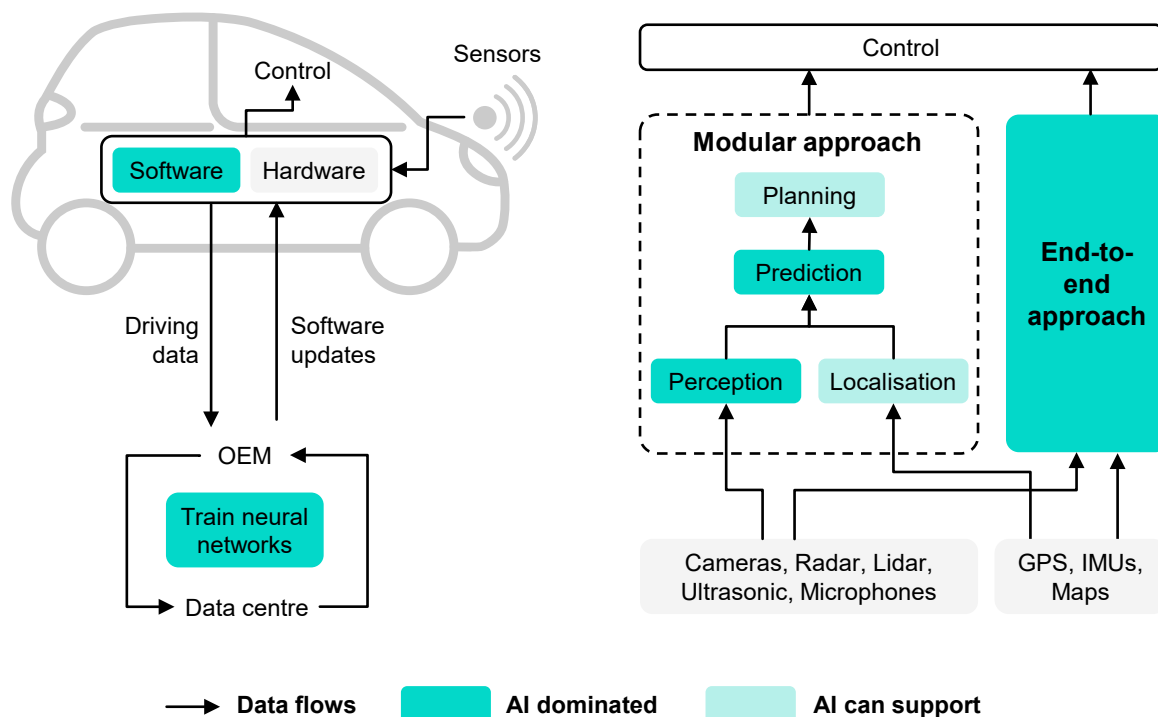

IEA. CC BY 4.0

Notes: OEM = original equipment manufacturer; AI = artificial intelligence; GPS = global positioning system; IMU = inertial measurement unit.

## AI can enhance battery management and charging co-ordination

Traditional battery management systems translate the voltage, current and temperature of a battery into state estimations using physics-based models. In an approach using AI, a machine learning model first learns relationships between voltage, current, temperature and charge/discharge history from lab data. Then, by collecting data from cars on the road, the lab-trained model can be [fine-tuned with real-world data](#). The improved models are then deployed to the fleet via OTA updates. More accurate battery state estimations increase battery life and driving range, benefiting not only car owners but also OEMs, who can refine warranty strategies.

AI techniques can also improve the co-ordination of EV charging by predicting grid loads, EV arrivals and departures, renewable generation and electricity prices.

These predictions are typically used by aggregators<sup>37</sup> to set charging schedules for individual EVs. Relying on third-party optimisation of charging schedules allows EV owners to [indirectly](#) engage in real-time pricing and ancillary markets and contribute to local grid balancing, reducing charging costs. The potential for benefits through AI-enhanced charging co-ordination increases further with the availability of vehicle-to-grid charging.

## Security considerations for connected and autonomous vehicles

### Semiconductor supply chains are highly concentrated

Modern vehicles already depend on [hundreds](#) of semiconductor chips, and autonomous vehicles need significantly more. The semiconductor supply chain is characterised by tight supply and high concentration. Just one company produces roughly [70%](#) of the world's pure-play foundry chips – chips that are designed by one company and manufactured by an external, specialised manufacturer.

Strengthening partnerships between automakers, chip designers and manufacturers is becoming increasingly important to secure access to critical components. This was underscored by the severe [disruptions](#) caused by the global chip shortages during the Covid-19 pandemic, and more recently by supply constraints experienced by the European automotive industry in 2025 linked to the [Nexperia crisis](#). These crises have drawn significant government attention. For example, the European Union adopted the [European Chips Act](#) in 2022, aiming to mobilise EUR 15 billion (around USD 16 billion) in public and private investments by 2030, [encompassing](#) research projects, training, technical expertise, pilot lines, and equity support to semiconductor start-ups.

The growth of data centres and AI adds further pressure on chip supply chains. As chip producers – particularly manufacturers of memory chips – tend to favour data-centre customers because of greater profit [margins](#), rapidly rising demand could result in supply disruptions for other sectors, including the [automotive](#) sector. As of October 2025, it was reported that average memory-chip inventories had [fallen](#) to around 3 weeks of demand, down from 15 weeks a year earlier.

---

<sup>37</sup> Aggregators in electricity markets are companies or platforms that combine (aggregate) many small electricity resources or consumers and participate in the power market as a single large player.

## The cybersecurity vulnerability of vehicles has been increasing

As the industry transitions toward SDVs and increasingly integrates autonomous-driving functions, ensuring stringent cyber-security controls and adopting high security standards will be vital. The risks associated with cyber threats mean that cybersecurity and software update management has become an integral component of vehicle design and operation.

Cyber-attacks could enable unauthorised access to data collected through in-vehicle microphones, cameras and sensors, or allow malicious actors to disable or remotely operate vehicles. For example, it has been [demonstrated](#) that security gaps in a 2020 Nissan LEAF could be exploited to remotely control steering and other critical vehicle functions. Further back, in 2015, researchers remotely [hacked](#) a Jeep Cherokee to gain access to steering, braking and acceleration controls. VicOne, a cybersecurity company, identified [more than 500](#) cyber vulnerabilities in vehicles already on the market in 2024.

Vulnerabilities in connected-car services can allow remote access to vehicles: for example, flaws in one brand’s system allowed attackers to remotely [unlock cars via the mobile network](#). More recently, researchers identified [web-portal vulnerabilities](#) affecting connected vehicles that could enable remote tracking or control of functions such as unlocking, honking or remote start using only basic vehicle information. Cyber risks extend to EV infrastructure: [research](#) has demonstrated wireless attacks capable of disrupting EV fast-charging sessions, with potential implications for vehicles and power grids.

**Figure 8.6 Number and source of identified cybersecurity vulnerabilities in vehicles, 2014-2024**

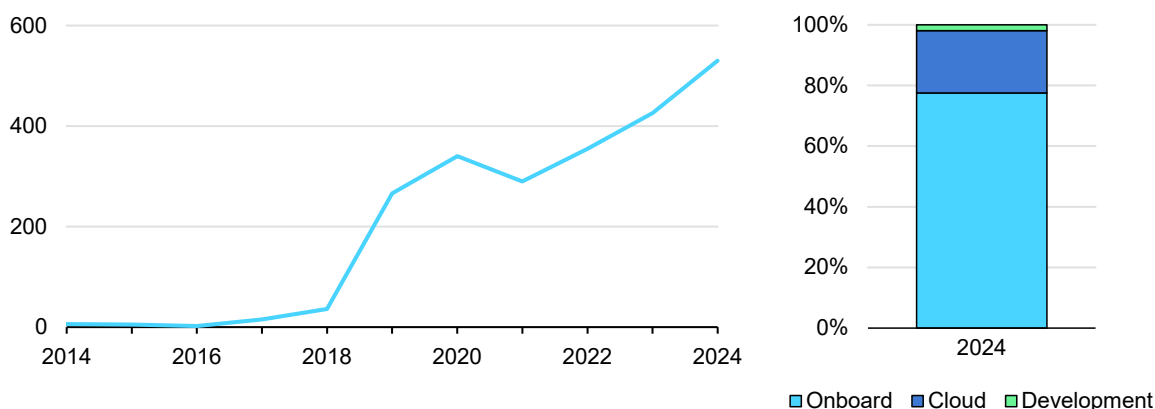

IEA. CC BY 4.0.

Notes: Onboard refers to all systems and components within the vehicle itself. Cloud refers to the cloud-based infrastructure, including vulnerabilities in IT systems, mobile or vehicle apps, and EV charging. Development refers to cyberattacks that target the tools and systems used to create, test, and update vehicle software.

Source: IEA analysis based on data from [VicOne](#).

# Ultra-fast charging batteries

## Advances in batteries and power electronics are improving EV performance

Over the past decade, average EV battery pack energy density (Wh/kg) has increased by around 60%, while prices have fallen by roughly 75%. Moreover, in 2023, battery-related patents accounted for [40%](#) of all energy-sector patents, suggesting that more developments are still to come. At the same time, new power-electronics materials, battery cell technologies and battery pack architectures are [enabling](#) more efficient, higher-voltage – and therefore faster – charging systems.

The battery pack voltage plays a key role in enabling faster charging, as the power that can be delivered to a vehicle is constrained by the maximum current that can flow through the charging station and vehicle charging system. At a given current, delivered power is proportional to the battery pack voltage – if the system power limits allow, doubling the voltage (e.g. from 400 V to 800 V) doubles the charging power. Alternatively, for a given power level, doubling the voltage halves the required current, and since resistive heat [losses](#) are proportional to the square of the current, it reduces them by 75%.

An electric vehicle battery pack is composed of hundreds or thousands<sup>38</sup> of battery cells, each typically operating at a voltage of around 3-4 volts (V). These cells can be connected in series or in parallel, with series configurations increasing the overall pack voltage to the required level. Most battery electric cars on the market today operate with battery systems of around 400 V, which has long been considered a suitable compromise between charging performance and battery pack complexity, cost and reliability. However, the increasing availability of ultra-fast charging infrastructure, alongside improvements in battery and vehicle technologies, as well as consumer concerns related to range and charging times, is accelerating the shift towards higher-voltage electric vehicle systems.

Raising battery pack voltage to enable faster charging not only requires a shift from conventional power-electronics materials, typically silicon, towards alternative semiconductors such as gallium nitride (GaN) and silicon carbide (SiC), but also reduces tolerance to battery cell-level defects. This requires even tighter control of cell quality to mitigate risks associated with minor manufacturing defects.

---

<sup>38</sup> Battery packs are typically composed of several hundreds of battery cells when using prismatic or pouch cells, and several thousands when using cylindrical cells. See Figure 7.12 for more information on the different cell form factors.

Improvements in battery design, manufacturing quality and underlying technologies over recent years have therefore been critical in enabling the current shift towards higher-voltage systems.

**Figure 8.7 Time required to fully recharge a battery electric car at different battery pack voltages and charging powers**

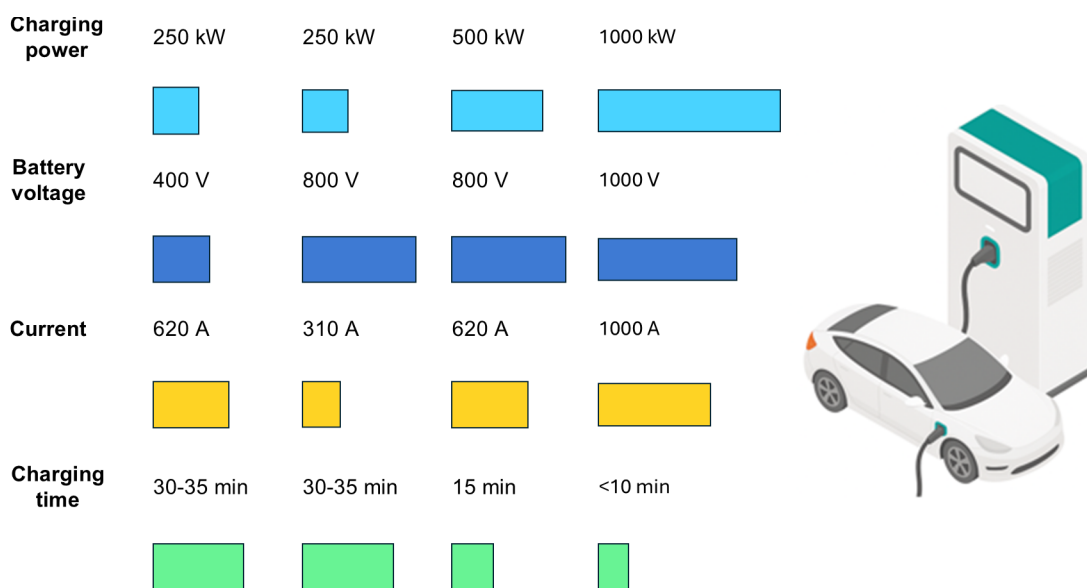

IEA. CC BY 4.0.

Note: Full charging time assumes that charging starts at a state-of-charge of 10% and end at close to 100%.

Higher voltage battery packs require lower electrical current and reduce heat losses, which benefits the charging system and associated cabling, but not the battery itself. As the voltage of individual battery cells is fixed and does not depend on the battery pack configuration, the current applied at the cell level during operation depends on the charging power. Ultimately, faster charging is therefore constrained by the ability of battery cells to safely withstand higher currents, which is typically characterised through the “C-rate”<sup>39</sup>, and by how efficiently these cells can be cooled down during charging to ensure safety.

The latest battery technologies – such as the BYD [blade](#) battery or CATL [Shenxing](#) – can reach up to 10C or 12C in the early phases of charging, compared to just over 2C when an average battery electric car is charged at 150 kW. When combined with high-voltage battery packs (above 800 V) and charging systems

<sup>39</sup> The C-rate indicates how fast the battery is being (dis)charged compared to its storage capacity. It is directly proportional to the applied current and inversely proportional to the charging time. For example, a C-rate of 2C indicates that the battery is charged through a current that is double its storage capacity (e.g. 120 kW for a battery pack of 60 kWh), while at C/2 implies a current half its storage capacity.

capable of handling very high currents, these advances have enabled megawatt-scale charging for passenger electric cars, first [introduced](#) by BYD in 2025. This enables close to a full charge in less than 10 minutes, comparable to combustion engine vehicle refuelling times.

**Figure 8.8 Voltage range of electric vehicle models by company headquarters and annual releases of new high-voltage models, 2019-2025**

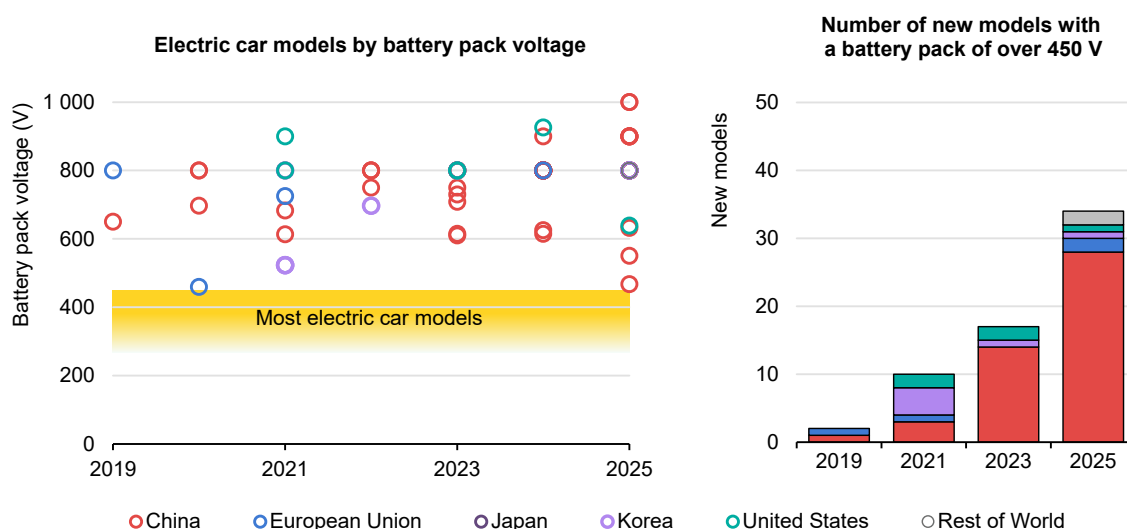

IEA. CC BY 4.0.

Notes: The same vehicle model may be offered with different battery packs featuring different voltage levels. For the purpose of this figure, if a model is available with a high-voltage system (>450 V), it is classified as such. Models for which battery pack voltage levels have not been disclosed are excluded.

Sources: IEA analysis based on data from [EV Volumes](#) and [Marklines](#).

The Porsche Taycan, introduced in 2019, was the first model to use an 800 V architecture – a stark change from the 400 V architecture used before that date, and which still accounts for most EV models available today. The Lucid Air, introduced in 2021, was the first to adopt a 900 V architecture. Since then, Chinese manufacturers have driven the development of high-voltage EV platforms (above 450 V), releasing more such models than all other automakers combined.

The trend towards greater EV battery voltage reached a turning point in 2025, with the release of the first-ever 1 000 V models (BYD Han L and Tang L) alongside [megawatt charging](#) for electric cars. Over the course of the year, more than 30 new high-voltage electric car models were released globally – over 80% of them by Chinese manufacturers – 25% more than in 2024 and twice the number of models released in 2023. The expansion of high-voltage battery packs and associated ultra-fast charging systems has continued into early 2026. Recent announcements include BYD’s 1.5 MW [“flash charging”](#) technology, Geely Group’s [Lynk & Co 10+](#), CATL’s [third-generation](#) Shenxing battery, and Sunwoda [Xingchi](#) Supercharge Battery 2.0 battery – all enabling charging times of under ten minutes.

For consumers to fully benefit from these technological advances, ultra-fast charging infrastructure must be reliable and sufficiently widespread (see [Chapter 6](#)). In addition, the electricity grids must be resilient enough to accommodate higher peak loads from faster EV charging as higher-voltage architectures and faster charging capabilities become more widespread. Today the number of electric cars able to use chargers above 250 kW remains limited, accounting for less than 5% of the vehicle stock in 2025, but sales are growing rapidly.

**Figure 8.9** Number of battery electric car models and cumulative sales per maximum charging speed, 2019-2025

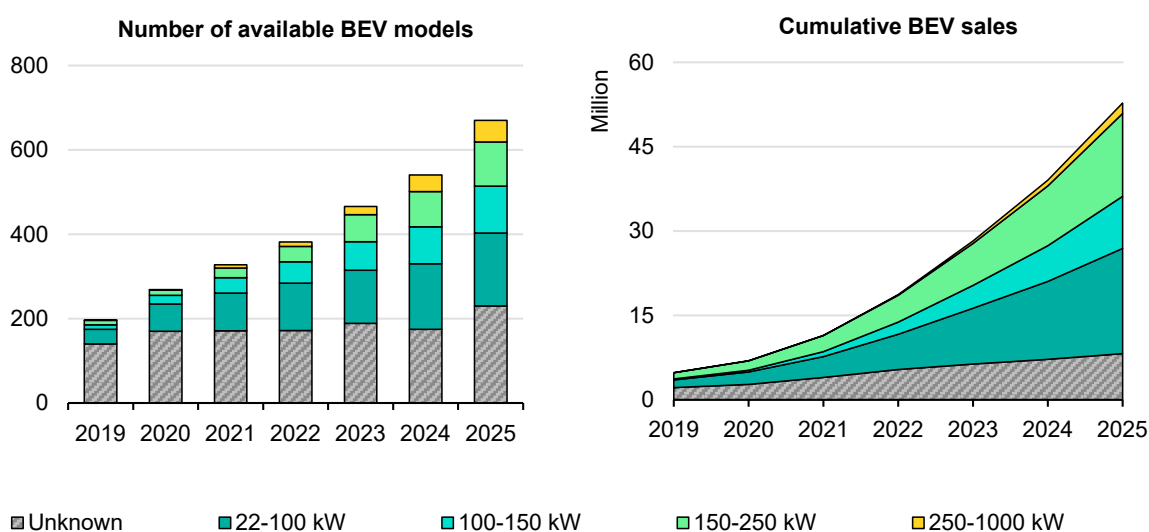

IEA. CC BY 4.0.

Notes: BEV = battery electric vehicle. Maximum DC fast-charging power (kW) is reported by EV Volumes where available. For models without a reported maximum charging power, battery pack voltage is used as a proxy to assign the model to the charging-speed categories shown in the figure. The proxy mapping is derived from the subset of models for which both charging power and pack voltage are available, using the observed distribution of charging-power categories within each voltage band.

Sources: IEA analysis based on data from [EV Volumes](#) and [Marklines](#).

## Vehicle-to-grid technology

### Vehicle-to-grid charging holds the promise of alleviating grid constraints, but barriers remain

The rollout of EVs is a major driver of [global electricity demand growth](#). Residential EV charging can draw more power than any other single household load, including heating, cooling, lighting and appliances. In addition, driving and charging patterns can concentrate demand in time, creating highly variable and difficult-to-predict loads that can lead to congestion and voltage issues in distribution networks. As power systems in many regions simultaneously integrate higher shares of variable

renewable generation, maintaining the balance between electricity supply and demand becomes increasingly complex and costly.

EVs offer substantial demand side flexibility via [smart charging](#). Beyond this, vehicle-to-grid (V2G) technology enables EVs to provide grid-stabilisation services through bidirectional power flow. Realising this potential, however, requires widespread deployment of V2G-compatible vehicles and chargers, multiparty interoperable communication protocols, as well as supportive testing regimes, regulatory frameworks, and financial incentives.

**Figure 8.10 Overview of different types of electric vehicle charging**

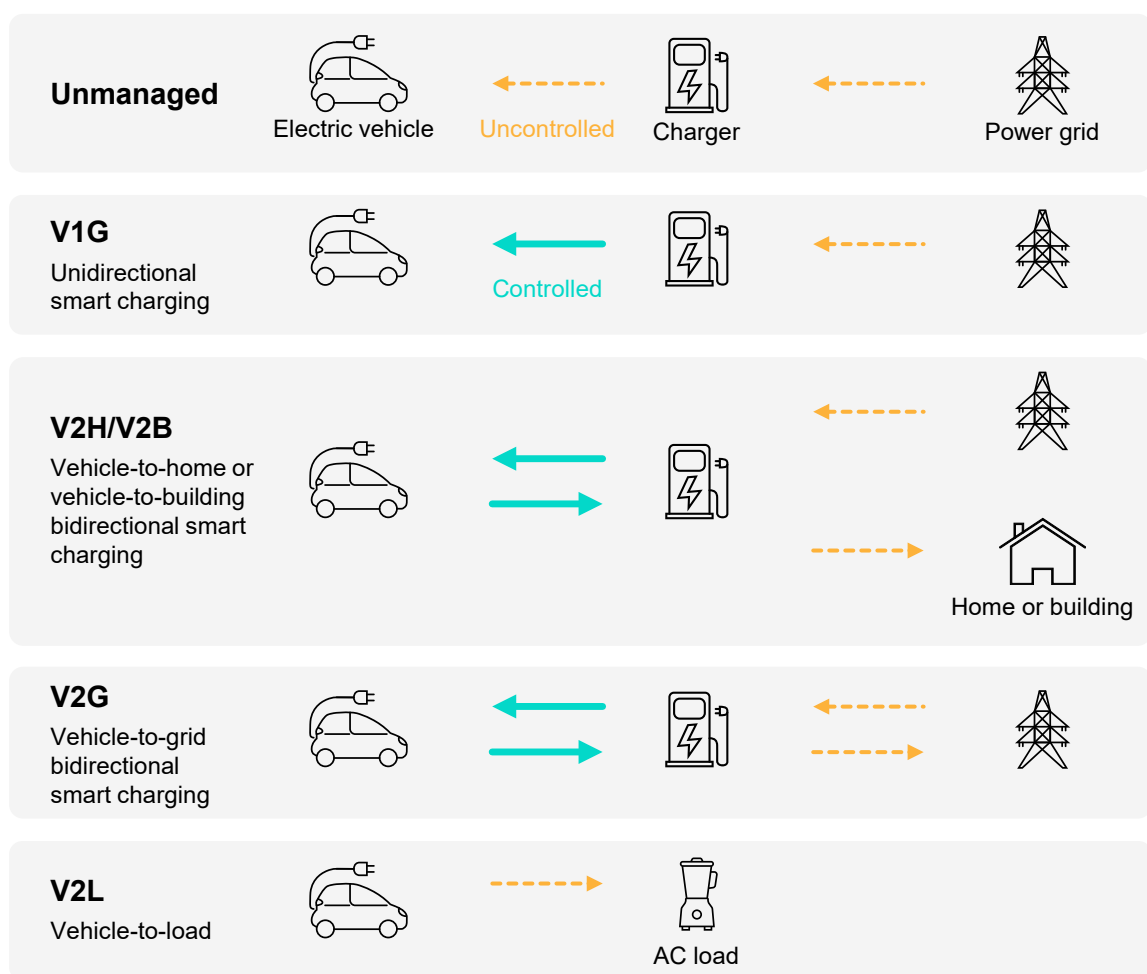

IEA. CC BY 4.0.

Notes: V1G = Unidirectional smart charging; V2H/V2B = Vehicle-to-home or vehicle-to-building bidirectional smart charging; V2G = Vehicle-to-grid bidirectional smart charging; V2L = Vehicle-to-load; AC = Alternating current.

Through controlled charging and discharging, EV batteries become flexible assets for energy storage rather than mere loads to the grid. There are varying degrees of flexibility. With unidirectional smart charging (V1G), the charging power can be modulated to align electricity demand with generation profiles or to alleviate grid congestion. With vehicle-to-building (V2H/V2B), the EV can additionally discharge energy for use in a home or building, either to serve as a backup during power outages or to lower electricity bills by leveraging dynamic tariffs and increasing self-consumption of rooftop solar. Finally, V2G technology can push energy from the EV battery into the power grid, unlocking the greatest potential for grid stabilisation and cost optimisation. Another form of bidirectionality is vehicle-to-load (V2L), where devices such as tools, appliances, and electronics can be powered or charged using the EV's battery through an alternating current (AC) outlet.

Enabling bidirectional charging introduces additional technical requirements for EVs. In particular, it affects the design and operation of battery management systems (BMS), power electronics and communication protocols, all of which must ensure safe delivery of outgoing current and strict compliance with grid requirements applicable to generators. In AC V2G systems, where the EV inverts the battery's direct current (DC) to AC, the vehicle's onboard power electronics are responsible for grid compliance, necessitating additional functionalities such as grid-frequency measurement. In DC V2G configurations, by contrast, these responsibilities are handled by the external charger. Battery management systems must ensure safe discharge while accurately enforcing state-of-charge and temperature limits to minimise degradation resulting from increased cycling. In addition, enhanced communication protocols are required, as EVs must convey not only charging constraints but also discharge limits and cycling parameters to the charger.

The charging station management system (CSMS), also known as the backend, functions as the communication interface between charger and grid, and as the main platform for data management and charging optimisation. It receives grid-side signals such as capacity constraints, time-of-use tariffs and requests for load shift, as well as vehicle-side information, including state-of-charge limits, cycling constraints and expected departure time. Based on these inputs, the CSMS calculates optimal charging schedules and transmits control commands back to the charger. In current commercial approaches, the backends are mostly run by aggregators as part of a packaged service to the EV owner.

**Figure 8.11 Energy and information flows between vehicle, charger and grid in vehicle to grid bidirectional charging**

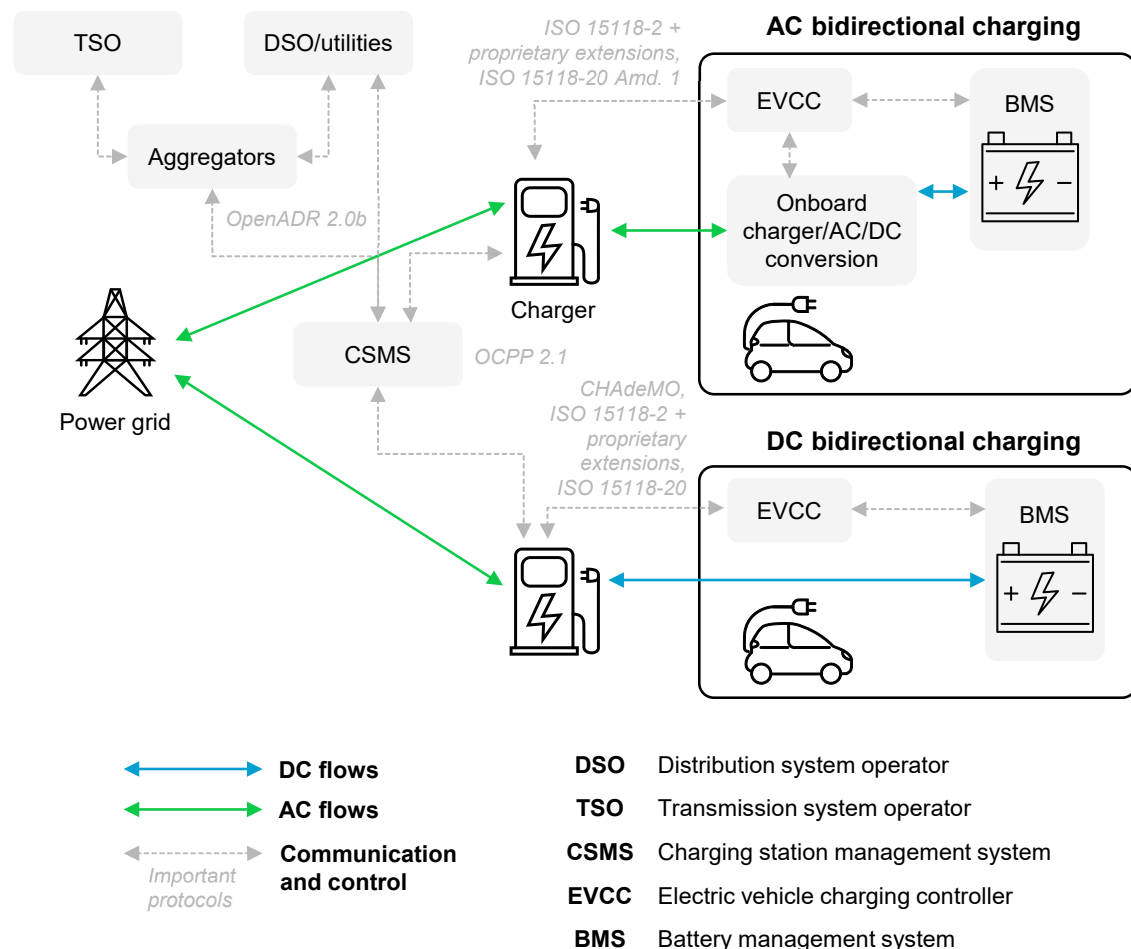

IEA. CC BY 4.0

Notes: DSO = Distribution system operator; TSO = Transmission system operator; CSMS = Charging station management system; EVCC = Electric vehicle charging controller; BMS = Battery management system; ISO = International Organization for Standardization; OCPP = Open Charge Point Protocol; OpenADR = Open Automated Demand Response; DC = direct current; AC = alternating current.

Sources: IEA (2022), [Grid Integration of Electric Vehicles](#); [Zecar](#).

## V2G can unlock new revenue streams for EV owners

### Flexibility enables fewer grid investment costs

With V2G technology, EVs become flexible assets to the grid and can serve as energy storage. While EVs with unidirectional smart charging can also contribute to demand flexibility, as can other end-use devices such as heat pumps in buildings, the potential of bidirectional charging of EVs is exceptional.

Quantifying and comparing the flexibility potentials of different technologies is a complex task. The content in this section of the report relies on analysis conducted by researchers at RWTH Aachen University on a specific case study of the

flexibility potential of different technologies. This compares EVs with V1G and V2G, sampling driving and charging behaviour from the [Mobility in Germany survey](#); from a battery energy storage system; and from an air-to-water heat pump used for space heating in an average German home, where flexibility arises from a buffer storage tank and a 0.5°C tolerance on the setpoint temperature in the building.<sup>40</sup>

The results show that EVs with V2G technology have the largest hourly energy flexibility of all technologies considered. The large battery capacity of EVs combined with the possibility to discharge opens wide theoretical corridors for load shifting and grid balancing. EVs with V1G show more limited flexibility than battery energy storage systems with much smaller energy capacity. This is because the flexibility potential for V1G depends on the state-of-charge when cars get plugged in. High state-of-charge of the EV at arrival, which in the sample used is around 88% on average, limits the flexibility potential. For space heating heat pumps, the flexibility potential depends strongly on the weather. During winter, heat pumps can be a potent source of load flexibility, but the effect diminishes quickly as heating demand drops in the warmer months.<sup>41</sup>

**Figure 8.12 Daily average hourly energy flexibility potential for different domestic grid-connected technologies**

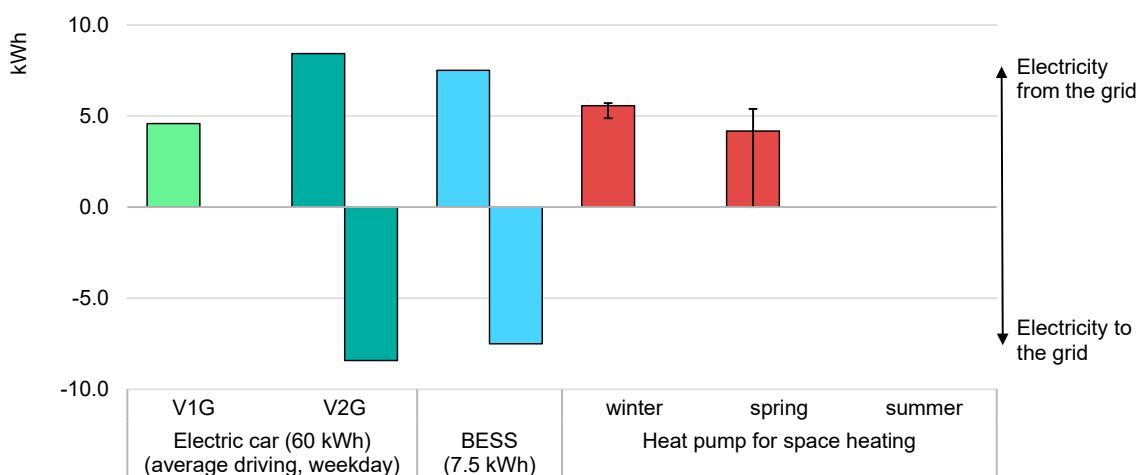

IEA. CC BY 4.0

Notes: V1G = unidirectional smart charging; V2G = vehicle-to-grid bidirectional smart charging; BESS = battery energy storage system. The average daily driving distance of EVs in the sample considered is 48 km, the EVs are plugged in for an average 18.5 h, and the average state-of-charge at arrival is 88%. Error bars for heat pumps indicate influence of weather during each season.

Sources: IEA analysis in collaboration with IAEW at RWTH Aachen University.

<sup>40</sup> See [Annex H](#) for a more detailed explanation of the methodology and assumptions.

<sup>41</sup> Heating demand for domestic hot water has not been considered here but constitutes another source of flexibility which is more stable throughout the year.

Potential reductions in grid investments through smart charging deployment are highly dependent on existing grid capacity and characteristics. A study on the impacts of EV deployment on the distribution network of [San Francisco](#) found that V2G charging could avoid three-quarters of transformer overloads by 2050 compared to uncontrolled charging, and half compared to unidirectional smart charging. A study on the German power grid predicted an up to [6% reduction](#) in distribution grid investment costs to 2040 with grid-friendly V2G compared to uncontrolled and cost-optimised smart charging. Considerable investments in the distribution grid were found to be necessary in all scenarios due to rollout of heat pumps and EVs; more sparsely populated regions saw comparably higher savings through grid-friendly charging. A study focused on a region in northern France found that V1G and V2G deployment could [reduce 2040 peak loads](#) on grids by 6% and 9%, respectively. Around one-quarter of yearly grid reinforcement costs could be saved compared to a case with low EV charging flexibility. The grid in this region has comparably high capacity due to the widespread use of electric domestic heating in France.

Smart charging can reduce generation and transmission capacity investments by reducing peak power demand as well as renewable curtailment. A study on [two regions in China](#) found that V2G can substantially reduce generation capacity investment costs, and this is especially true in regions with high renewable shares. Analysing the optimal buildout of European charging infrastructure, another study found that V1G can provide [substantial energy system cost savings](#) compared to uncontrolled charging (2-5%). The additional benefits from V2G are most prevalent under transmission grid expansion constraints and high shares of solar PV in electricity generation. Another study across various European countries found similar savings, largely attributable to the [reduced capital expenditure](#) on flexible generation capacity.

Incentivising load shifting through static time-of-use tariffs can, however, lead to a large share of EVs charging or discharging at the same time, [exacerbating grid impacts](#) compared to uncontrolled charging. With various forms of co-ordination such as [dynamic tariffs](#), [local grid-aware control](#), or [aggregator control](#), it is possible to flatten load curves on distribution grids and potentially reduce the need for upgrading power lines and transformers.

## Additional revenue streams improve the economic proposition of EVs

EV owners can be remunerated for providing flexibility to the grid, thus improving the economics of EV ownership and potentially accelerating adoption. The possible revenue streams include energy arbitrage, ancillary services, and distribution level services. Through V2G technologies, EV owners can engage in energy arbitrage, meaning charging the vehicle battery when electricity prices are

low (often during periods of high renewable generation) and discharging energy back into the grid when prices are high. Through participation in ancillary services, EV owners are remunerated for flexibly adjusting charging or discharging to assist grid operators in maintaining frequency stability. At the distribution level, EV owners can be remunerated for shifting their load or providing power to alleviate local network congestion. Under bilateral contract or flexibility tenders, they also can assist with restoring power after a fault.

There are several market and remuneration mechanisms for EV owners to stack revenue. Depending on the domain of intervention, either at transmission or distribution level, EV charging flexibility may directly access wholesale and ancillary services markets (usually through aggregation), or local flexibility markets, and dedicated tariffs.

**Figure 8.13 Possible revenue streams for electric vehicle owners with vehicle-to-grid charging**

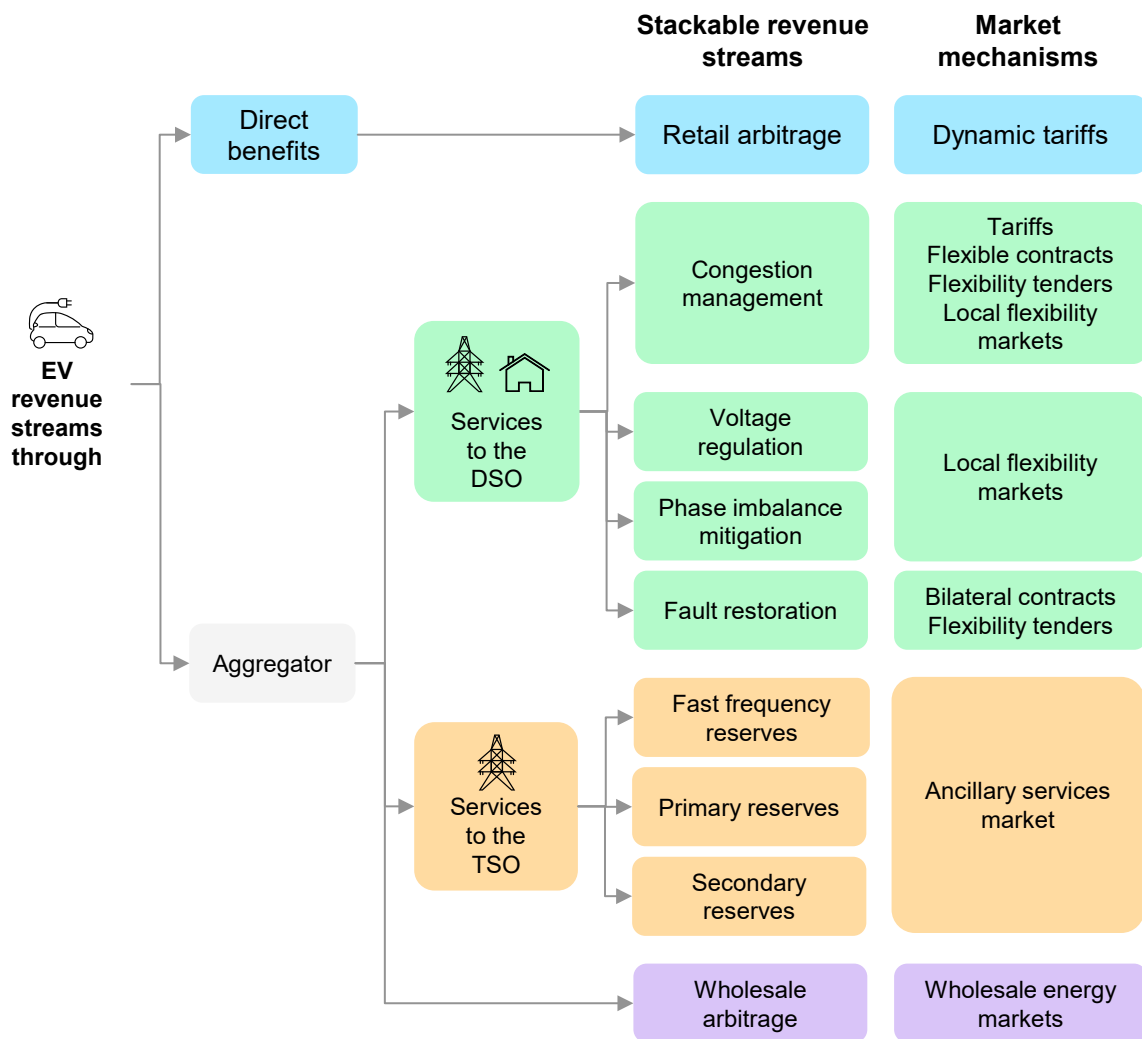

IEA. CC BY 4.0.

Notes: EV = electric vehicle; DSO = distribution system operator; TSO = transmission system operator.

Sources: IEA (2022), [Grid Integration of Electric Vehicles](#); IRENA (2019), [Electric-Vehicle Smart Charging](#).

Estimates of revenues for EV owners participating in V2G charging range between [several hundred](#) to [over USD 1 000](#) per year. Current commercial offerings promise customer benefits of up to USD 770, through [free charging](#) or through [remuneration for every hour](#) the EV is plugged in. In these examples, charging is managed by a utility functioning as aggregator that interacts with energy and ancillary services markets. Revenues from selling ancillary services such as [voltage regulation](#) are seen as [key for near-term profitability](#), whereas returns for these services are expected to decline with increasing deployment of V2G.

## First commercial offerings show technology readiness

### V2G model availability is growing but still remains limited

While the number of models with V2G charging capabilities has seen rapid growth over the last 2 years, these models remain scarce and mostly not capable of multiparty interoperability. Counting OEM statements and models commercially used for V2G, 22 models have V2G capabilities today, accounting for less than 1.5% of all EV models. When accounting for all bidirectional capabilities, i.e. including V2H and V2L-capable models, the value is at least three times higher. Despite producing over half of EV models globally, Chinese OEMs only account for one of the models with commercialised V2G capabilities, which is used in one of the first V2G offers available to private EV owners worldwide, in the [United Kingdom](#). The range of available models span different size classes and prices, from small cars like the Renault Twingo, to large SUVs like the Hyundai Ioniq 9 or Tesla's Cybertruck, with prices ranging from under USD 25 000 to over USD 70 000.

Early V2G deployments were based on CHAdeMO, which enabled the first commercial bidirectional charging systems, but usage is now declining outside Japan. Among other current charging ecosystems, only the Combined Charging Standard (CCS), via [ISO 15118-20](#), defines a fully standardised V2G communication pathway, while the Chinese GB/T supports V2G mainly through partial, system-integrated implementations. The North American Charging Standard (NACS) is still relatively new, with V2G capabilities not yet fully specified. However, V2G was not part of the original communication standard used in CCS (ISO 15118-2:2014) and was only added in 2022. This partly explains why only a few OEMs have specified models as being V2G-capable as of today, even though other models have been used in pilot projects. On the other hand, it is possible that more models could be enabled for V2G through over-the-air software updates in the future, similar to [Volkswagen activating V2H](#) for some models in 2024.

**Figure 8.14 Number of electric vehicle models in production with vehicle-to-grid charging capability, 2020-2026**

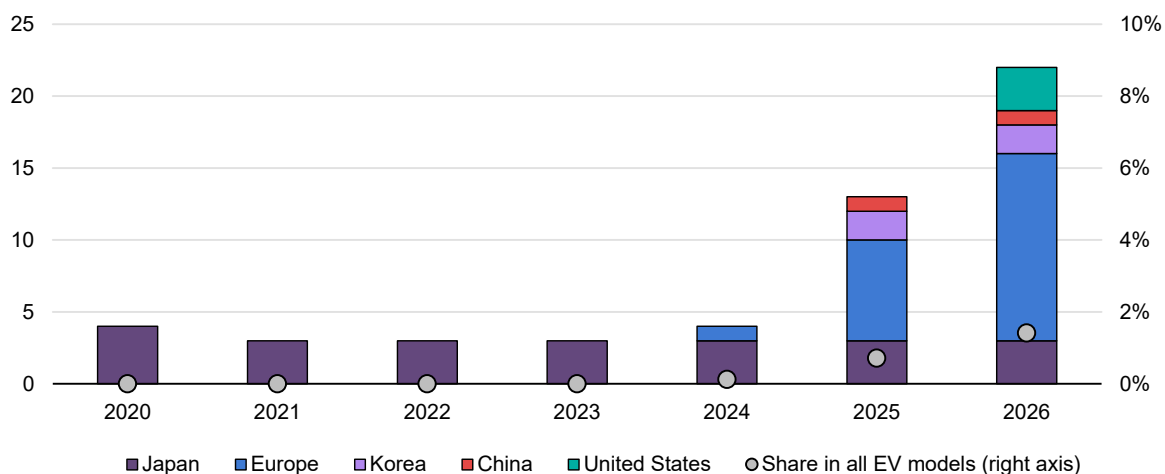

IEA. CC BY 4.0.

Note: Models included only if capability stated by manufacturer during years of production.  
Sources: IEA analysis based on ev-database.org and OEM webpages.

On the charger side, the situation is similar, with few models on the market but [many more announced](#). Prices vary considerably between AC and DC chargers. Whereas bidirectional AC chargers are available for [less than USD 1 500](#), DC chargers can [cost USD 5 000](#) and upwards. Considering a benefit to the EV owner of around USD 500 per year, payback periods for installing a bidirectional charger at home vary from about 2 years for AC chargers to up to 10 years for DC chargers. V2G chargers must be both certified for the grid codes of each country and able to communicate with EV models.

Despite the standardisation of the CCS communication protocol for V2G in ISO 15118-20, interoperability between chargers and EVs is currently extremely low, as implementation of the new standard varies considerably between OEMs. All current commercial offerings are packages comprising specific EV models, specific chargers, and a tariff offered by a specific utility.

**Table 8.3 List of models in production with V2G capability as stated by manufacturer, 2026**

Brand	Model	Connector	AC or DC V2G	Multiparty interoperable	Countries with commercial V2G offerings
BMW	iX3	CCS	DC	No	Germany
BYD	Dolphin	Type 2	AC	No	United Kingdom
Ford	Capri	CCS	DC	No	Germany
	Explorer	CCS	DC	No	Germany

Brand	Model	Connector	AC or DC V2G	Multiparty interoperable	Countries with commercial V2G offerings
Hyundai	Ioniq 9	Type 2	AC	No	-
Kia	EV9	Type 2	AC	No	-
Mitsubishi	Outlander PHEV	CHAdeMO	DC	Yes	United Kingdom
	Eclipse Cross PHEV	CHAdeMO	DC	Yes	-
Mercedes-Benz	CLA	CCS	DC	No	-
	GLC	CCS	DC	No	-
Nissan	LEAF	CHAdeMO	DC	Yes	United Kingdom
Renault	4	Type 2	AC	No	France, Netherlands
	5	Type 2	AC	No	France, Netherlands
	Twingo	Type 2	AC	No	France
	Megane	Type 2	AC	No	France
	Scenic	Type 2	AC	No	France
Tesla	Cybertruck	NACS	AC	No	United States (Texas)
VW	ID.3	CCS	DC	No	-
	ID.4	CCS	DC	No	-
	ID.5	CCS	DC	No	-
	ID.7	CCS	DC	No	-
	ID.Buzz	CCS	DC	No	-

Notes: Discontinued models are not included in this list. Commercial use is defined as availability to private end-users including car, charger and tariff, and not limited in numbers (as in pilot projects). Sportscar brands are excluded.

## Regulatory advances have enabled the first commercial V2G offers in Europe

The rollout of V2G hinges on the establishment of a regulatory and electricity market framework that enables market players to deploy the technology needed to untap the benefits of flexible loads.

Some of the key regulatory features required include differentiated tariffs, market access for aggregated loads, ancillary services market access and local flexibility procurement. Differentiated tariffs (e.g. time-of-use, dynamic real-time, critical peak pricing, locational signals) are varying tariffs, giving the EV owner price

signals and allowing for implicit demand side flexibility (DSF).<sup>42</sup> Allowing EVs to participate in the provision of ancillary services (voltage support, frequency control, and emergency and restoration plans) supports the operation of the transmission or distribution system. Lastly, opening local flexibility procurement to EVs can help reduce congestion and thereby minimise the risk of outages and the need for expansion investments.

Over the past year, there has been significant progress across many regions on the necessary legal frameworks for V2G. Building on mature frameworks, the first-ever commercial V2G offerings appeared, mostly in Europe. Aggregation of EV charging for grid balancing and providing ancillary services has been enabled in [Finland](#), [France](#) and [Denmark](#). The [Brazilian electricity market](#) reform in 2025 enables the development of aggregators and differentiated tariffs, while [Thailand](#) has established policy sandboxes to enable vehicle-to-grid pilot projects.

European countries are currently leading the rollout of V2G. All the necessary conditions for V2G are currently met in France, the Netherlands and the United Kingdom, and commercial V2G offerings are available in those countries. Germany [eliminated double grid fees](#) for bidirectional charging points at the end of 2025, paving the way for the appearance of the first commercial offers shortly after. The European Union has also defined minimum requirements for all new chargers from 2027, [including bidirectional capability](#) and ISO 15118-20 support.

**Table 8.4 Progress of V2G legal framework requirements for selected countries**

Region	Country	Market access and legal frameworks				Technology availability			
		Differentiated tariffs	Aggregators	Ancillary services	Local flexibility	Standards and legal definitions	Smart charging rollout	V2G models availability	V2G commercial offering
Africa	South Africa	●	●	●	●	●	●	●	●
Asia Pacific	China	●	●	●	●	●	●	●	●
	Indonesia	●	●	●	●	●	●	●	●
	Korea	●	●	●	●	●	●	●	●
	Thailand	●	⚡	⚡	⚡	●	●	●	●

<sup>42</sup> Explicit DSF is dispatchable flexibility traded in energy markets, managed by an aggregator or supplier, often referred to as "incentive driven". We can refer to Implicit DSF when consumers adjust their behaviour to respond to price signals, often through hourly pricing, to save on energy costs, which is often referred to as "price-based".

Region	Country	Market access and legal frameworks				Technology availability			
		Differentiated tariffs	Aggregators	Ancillary services	Local flexibility	Standards and legal definitions	Smart charging rollout	V2G models availability	V2G commercial offering
Central & South America	Brazil	●	↗	●	↗	●	●	●	●
	Chile	●	●	■	●	●	●	●	●
Europe	Denmark	●	↗	↗	↗	●	●	●	●
	Finland	●	↗	●	●	↗	●	●	●
	France	●	↗	↗	●	●	●	●	↗
	Germany	↗	●	●	↗	↗	●	●	↗
	Netherlands	●	●	●	●	●	●	●	↗
	Italy	●	●	↗	↗	●	↗	●	●
	United Kingdom	●	●	●	●	●	●	●	↗
North America	United States	●	●	●	●	●	●	●	↗

Notes: Evaluation overview: green = measures in place; orange = field test/pilot, or measures announced phase (for commercial offerings yellow means availability only in part of the country); red = no framework; ↗ = aspect has improved since 2024. Assessment for the United States is based on an aggregate of state rules based on the US [Federal Energy Regulatory Commission](#).

## V2G deployment has entered the pilot stage in many countries, notably in China

Pilots and pre-commercial deployment of V2G are now gathering pace across many regions. In China, while aggregation and parts of the communication protocols are still under development, the government has set ambitious V2G deployment targets. This included announcing [30 pilot projects](#) across 9 cities in 2025, and targeting the deployment of [5 000 V2G charging facilities](#) by the end of 2027. A barrier to full commercialisation of V2G in China is that bidirectional charging protocols for the GB/T standard have [not yet been fully standardised](#). Similarly, higher-level communication protocols between the charger, aggregator and grid are today proprietary or altogether absent.

Pilots and pre-commercial deployment of V2G are gathering pace across many regions. In 2026, the National Electric Energy Agency (ANEEL) in Brazil authorised a V2G [pilot project](#), enabling the use of V2G billing through aggregation with the use of EVs, solar power generation and energy storage systems. In Korea, Hyundai Motor Group is leading a [AC V2G pilot](#) project aligning with a recent grid-code update proposal by the Korean Electric Power Corporation

(KEPCO). One of Australia's largest utility providers is trialling a limited [V2G subscription bundle](#) including a BYD Atto 3, a bidirectional charger and a dedicated tariff.

## Scalable V2G requires multiparty interoperability and advanced battery management systems

### Communication standards exist but implementation is currently inconsistent

The international communication standard enabling bidirectional power transfer between EVs and chargers with CCS connectors, [ISO 15118-20](#), was published only in 2022, amended in the following years, and has not yet been implemented consistently and universally. The current version of the standard leaves manufacturers room for different interpretations of various aspects and features. Currently available [V2G offers](#) are therefore limited to one (or few) EV models – and one charger–model pairing, using proprietary communication protocols. Test procedures to ensure conformity with ISO 15118-20 and multiparty interoperability across EV and charger brands are still [under development](#), notably by [Task 53](#) of the IEA's Electric Vehicles Technology Collaboration Programme. Policy support should favour multiparty interoperable solutions when available, to foster customer choice and competition among vehicles, chargers and aggregator platforms.

In addition, regional differences between grid codes and regulations mean that EVs and chargers might only be able to engage in V2G charging in one country or region. This is compounded by [standardisation gaps](#) in linking grid signals through grid operator and aggregator to EV-charger communication. This explains why today's commercial V2G offers do not yet extend beyond a single country and are tied to a specific utility. Harmonising grid codes and improving standardisation of communication links, as [proposed by UNECE](#), could facilitate global interoperability of EVs, chargers and energy market actors.

### Advanced battery management systems maximise the economic value of V2G operations

One of the [main concerns](#) with V2G raised by customers and OEMs in the past has been accelerated battery degradation through increased cycling. However, recent testing and modelling shows that battery degradation in V2G applications can be [limited effectively](#) while providing revenue to the EV owner through grid services.

Well-managed V2G can even [reduce capacity loss](#) compared to unmanaged charging. [Degradation](#) of battery performance is due to a combination of calendar ageing, which strongly depends on the average state-of-charge, and cyclic ageing,

which increases disproportionately with cycling depth and when approaching upper and lower charge limits. Compared to uncontrolled charging, where the battery is charged as soon as possible, the average state-of-charge is normally lower in V1G and V2G applications, counteracting the effect of increased cycling.

OEMs seek to limit the risk of warranty costs while EV owners need clarity that V2G revenues outweigh any loss of value due to battery degradation. Typical warranties on EV batteries today guarantee 70% capacity retention after 8-10 years or 160 000 driven kilometres. Increased battery usage due to V2G therefore poses a financial risk to OEMs, who currently seek to mitigate these risks through various measures. As discussed above, many models today only allow V2L and/or V2H/B instead of V2G, where cycling is normally limited. Where V2G is enabled, OEMs seek control over V2G operations by requiring approved or proprietary chargers and by limiting energy throughput. A key component for scaling up V2G lies in the deployment of battery management systems with integrated predictive degradation models, which allow for more accurate cost-benefit optimisation during V2G operations, and increased customer confidence.

# Chapter 9. EV and battery outlook

## Scenario overview

A scenario-based approach is used to explore the outlook to 2035 for electric mobility, drawing on recent market trends, policies and technology developments.

Scenarios projections present possible futures for global electric vehicle (EV) markets and their implications for the energy sector. None of the scenarios represent a forecast or are intended to make predictions about the future. The main objective is to provide insights to policy makers and stakeholders regarding the future evolution of the EV market.

Two policy-based exploratory scenarios are presented: the [Current Policies Scenario](#) (CPS) and the [Stated Policies Scenario](#) (STEPS). A third scenario, the [Net Zero Emissions by 2050 Scenario](#) (NZE Scenario), is a normative scenario that outlines a pathway to reducing global energy-related CO<sub>2</sub> emissions to net zero by 2050.

The **Current Policies Scenario** considers no change in the current snapshot of policies and regulations that are already in place and offers a cautious perspective on the pace at which emerging energy technologies, including EVs, are deployed and integrated into the energy system. In this scenario, potential constraints – such as insufficient infrastructure, limited institutional capacity, financing challenges, or the absence of sustained policy support, along with a less optimistic outlook for technology cost reductions – impede increases in adoption rates of these technologies. As a result, growing EV deployment is primarily concentrated in markets with strong policy frameworks, while being more subdued elsewhere, with sales shares remaining close to current levels over time. Improvements in the efficiency of conventional vehicle technologies also slow from historical levels, as the CPS assumes that standards are not strengthened any further after their specified policy period, which is relevant to energy and emissions impacts.

The **Stated Policies Scenario** considers the implementation of a broader set of policies, including those that have been formally put forward but not yet adopted, as well as other official strategy documents that indicate the direction of travel. Barriers to the deployment of emerging technologies are assumed to be lower than in the CPS; however, the STEPS does not assume that aspirational targets will necessarily be achieved, the prospects and timing for their realisation are subject to an assessment of relevant market, infrastructure and financial constraints. The STEPS aims to hold up a mirror to the plans of policy makers and examine their consequences.

The **Net Zero Emissions by 2050 Scenario** takes a different approach by outlining a pathway to reduce global energy-related CO<sub>2</sub> emissions to net zero by 2050, and is consistent with a long-term goal of limiting the rise in global average temperatures to 1.5°C (with a 50% probability). There are many possible paths to achieve net zero CO<sub>2</sub> emissions globally by 2050 and many uncertainties that could affect them. The NZE Scenario is therefore a path and not *the* path to net zero emissions, and the IEA recognises that each country will take its own route.

[All IEA scenarios](#) have the same socioeconomic assumptions (i.e. population and economic growth). However, they differ in their assumptions about policies, long-term goals, and the ability to overcome technological barriers. This approach allows for a comparison of the effects and implications of different energy choices against a common backdrop.

The projections presented in this report consider historical market data and stated policies up until the end of March 2026. These scenario projections incorporate GDP assumptions from the International Monetary Fund and Oxford Economics as well as population assumptions from the United Nations, as described in the IEA's 2025 [Global Energy and Climate Model documentation](#).

## Vehicle outlook by mode

By 2035, the fleet of EVs across all vehicle types except two/three-wheelers (2/3Ws) exceeds 450 million globally in the CPS – more than five times as many EVs as there were at the end of 2025. CO<sub>2</sub> and fuel economy standards, especially for new light-duty vehicles (LDVs), are the main driver of rising EV sales outside of the People's Republic of China (hereafter, “China”). In China and a few other emerging markets, the competitive economics of EVs already support continued adoption in the CPS. Elsewhere, however, EV sales stall, particularly in regions with limited policy support or inadequate charging infrastructure.

In the STEPS, EV deployment follows a trajectory similar to in the CPS, but with higher growth, especially in regions outside Europe and China – EVs across all vehicle types increase by around six times, without counting two- and three-wheelers (2/3Ws). Overall, the majority of EV market expansion – from 21 million electric cars today to 55 million electric cars by 2035 – takes place in emerging markets and developing economies (EMDEs), highlighting the critical role these economies will play in the coming decade. In this scenario, the stock of EVs (excluding 2/3Ws) increases at an average rate of about 20% per year. More than 90% of these vehicles are electric cars, a share similar to that observed in 2025. In contrast, the NZE Scenario sees a significantly faster expansion of the EV fleet (excluding 2/3Ws) by 2035, reaching close to 800 million.

By 2035, the stock of electric 2/3Ws reaches around 200 million in the CPS and around 300 million in the STEPS, representing a fourfold increase compared to today’s levels. The CPS sees adoption of electric 2/3Ws grow particularly for commercial use cases, thanks to the competitive total cost of ownership. EVs account for around 22% of all vehicles on the road (including 2/3Ws) by 2035 in the CPS, and over 25% in the STEPS, with most of the difference between CPS and STEPS to come from buses and 2/3Ws. In the NZE Scenario, the corresponding share reaches around 45%, reflecting higher levels of policy ambition and technology deployment.

The share of the global EV stock located in China declines from 70% in 2025 to over 55% by 2035 in the CPS and around 50% in the STEPS, as adoption accelerates in other markets.

**Figure 9.1 Electric vehicle stock by mode and scenario, 2025-2035**

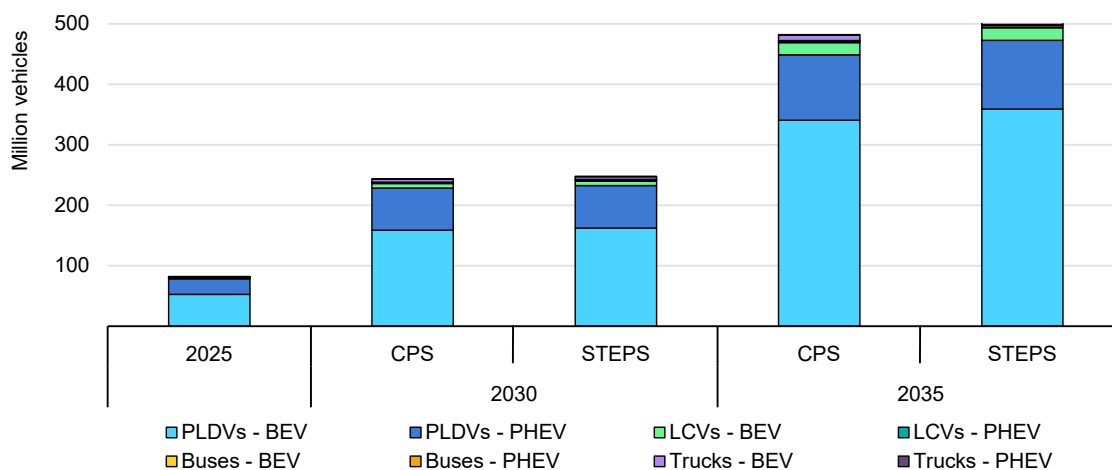

IEA. CC BY 4.0.

Notes: CPS = Current Policies Scenario; STEPS = Stated Policies Scenario; BEV = battery electric vehicle; PHEV = plug-in hybrid electric vehicle; PLDV = passenger light-duty vehicle; LCV = light commercial vehicle. Regional projected EV sales and sales shares data can be explored in the interactive [Global EV Data Explorer](#).

In terms of market share, electric 2/3Ws reach close to 60% in the STEPS. Although electric buses and electric LDVs had roughly similar EV stock shares in 2025, the sales share of electric buses grows more slowly, reaching close to 25% globally by 2035 in the STEPS. This slower growth reflects the challenges faced in electrifying intercity buses. In the CPS, around 10% of the global bus stock is electric in 2035, and in the STEPS, this share is slightly more than 15%. The NZE Scenario sees faster adoption of electric buses over the same period, reaching 40% of the bus stock.

Truck electrification continues to grow, across both medium and heavy freight trucks, supported by policy measures (such as emissions standards in the European Union) and cost-competitiveness, particularly in China. The rapid

growth observed over recent years in China, driven by the technology’s cost-competitiveness in this vehicle segment, explains the higher overall share of electric trucks in the CPS compared with buses. Over the coming decade, China plays a larger role in global truck sales than in global bus sales. By 2035, electric trucks reach around 20% of truck sales globally in the CPS, while about 10% of the truck stock is electric. Electrification is faster in the STEPS, with the market share 3 percentage points higher, and the NZE Scenario assumes a substantially higher uptake of electric trucks by 2035, with a market share around two times higher than in the STEPS.

**Figure 9.2 Electric vehicle sales share by mode and scenario, 2025 and 2035**

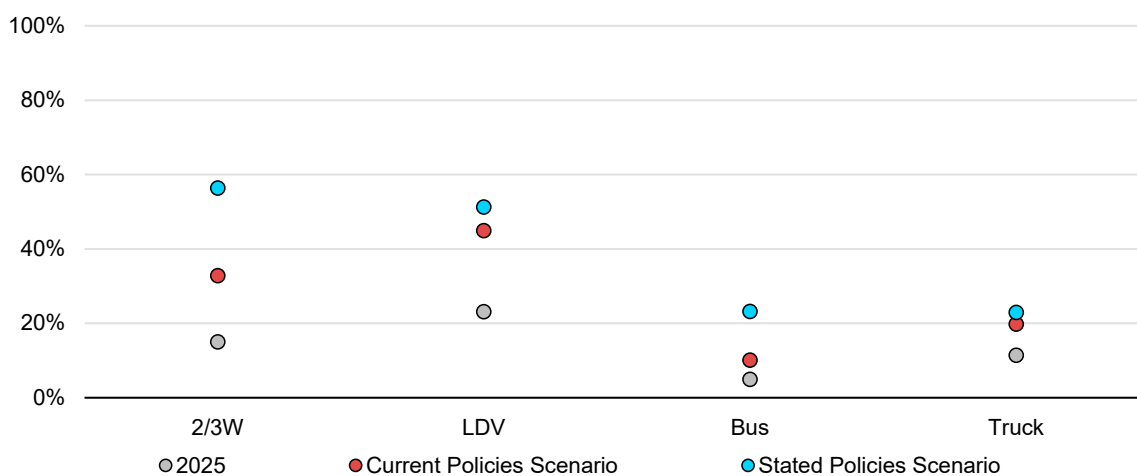

IEA. CC BY 4.0.

Note: 2/3W = two/three-wheeler; LDV = light-duty vehicle.

**Box 9.1 Impact of the high oil price environment on the electrification outlook**

The closure of the Strait of Hormuz as a result of the conflict in the Middle East has led to an increase in the prices of crude oil and oil products across the world. Uncertainty over the future reopening of the Strait therefore casts shadows over future oil prices. A prolonged high oil price environment is likely to have consequences on the outlook for EV sales, as they can provide a medium-term solution to reduce the financial burden of higher oil prices and oil import dependencies.

In the past, energy crises have triggered policy action that incentivises the deployment of energy-saving technologies. Given the magnitude of this crisis, it is likely that governments will react in a similar way. For road transport, a new feature

of this energy crisis is that policies supporting EVs can also improve the affordability of car, or other vehicle, ownership. Today, in contrast with previous energy crises, there are a number of manufacturers – mostly from China – who are able to offer price-competitive EVs, which can reduce dependency on oil while also reducing monthly energy bills for transport.

However, not all countries have the same incentives to further promote EV sales. While many elements are at play, three factors have been identified that can help understand which countries are more likely to double down on support for electric cars if oil prices stay high.

- Countries with high **oil import shares** will see either increased consumer expenditure at the pump, or increased government budgets to keep prices down through subsidies or tax rebates – all while facing higher import bills in their balance of payments. Importing countries also face a higher risk of physical oil supply disruptions. While countries that are less dependent on imported fossil fuels may still be facing price-pressure at the pump, the impact on the balance of payments is likely to be less severe, as at least part of the additional expenditure in a high oil price environment would be redistributed domestically.
- Another factor is the **weight of road transport on household expenditure**. Countries where the cost of running a car represents a relatively high share of household income are more likely to face pressure to further deploy electric cars that can support affordability. In EMDEs, the impact of an increase in gasoline prices would have a larger impact on household incomes since average incomes are lower compared to advanced economies. At the same time, drivers in EMDEs typically have lower yearly mileages, thus tempering this impact. In advanced economies, households [in the lowest income decile spend more than 20%](#) of their income, more than twice the share of a household with a median income, on energy, despite consuming around one-third less. Therefore, in all regions, at least some parts of the population are significantly affected by higher fuel prices.
- A third factor – the **presence of a domestic internal combustion engine (ICE)-based car industry** – might determine the likelihood of faster policy action. Regions without a significant domestic car industry are more likely to be open to imports of low-cost electric cars made in China – at least for the duration of the high oil price environment. Conversely, countries with a significant domestic industry might be more reticent to consider this option, limiting their offers to domestically produced EVs, which are often (though not always) more costly than Chinese imports.

This framework suggests that oil-importing EMDEs across the world have some of the strongest incentives to implement policies to further speed up electric car adoption, thus reinforcing momentum in some of the countries that are already

seeing the fastest growth in EV sales. These include, for example, countries in Southeast Asia (e.g. Thailand), Latin America (e.g. Chile) and Africa (e.g. South Africa). In the short term, this could mostly be achieved by increasing imports of affordable Chinese electric cars, while in the longer term, incentivising domestic supply could also be an option.

## Vehicle outlook by region

The evolution of EV sales shares varies by region, scenario and vehicle category. This section focuses on electrification trends in key markets – China, Europe (including a dedicated analysis of the European Union), the United States, Japan, Korea, India, Southeast Asia, and Latin America.

**Figure 9.3 Electric vehicle sales share by mode, region and scenario, 2035**

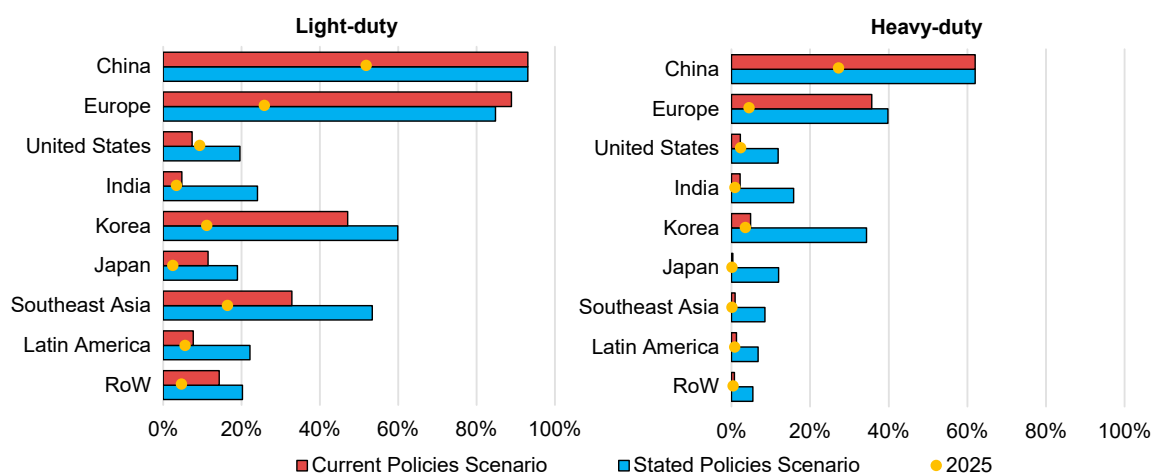

IEA. CC BY 4.0.

Notes: RoW = Rest of World. Light-duty refers to passenger light-duty vehicles and light commercial vehicles. Heavy-duty refers to buses, medium and heavy freight trucks. Regional projected EV sales and sales shares data can be explored in the interactive [Global EV Data Explorer](#).

## Affordability remains the defining feature of China's electric mobility transition

After rapid expansion since 2019, EV sales growth in China slowed in 2025 compared to that seen in previous years (see [Chapter 1](#)). However, today more than ever, China's automotive industry is deeply oriented toward electric models. For several years, more than half of the electric cars sold have been cheaper than comparable internal combustion engine (ICE) cars, and further battery price declines in 2025 (-8%) have supported that cost advantage. Today's competitive economics and firmly established policy frameworks result in the EV projections

in the CPS and STEPS following the same trajectory. For China, full electrification of road transport appears a matter of “when”, not “if”.

In the CPS and STEPS, electric cars and vans reach more than 90% of total sales by 2035, up from close to 55% in 2025. This trajectory is supported by continuous improvements in affordability and by policy frameworks that continue to tighten. In the short term, the new energy vehicle (NEV) credit target under the [Dual Credit System](#) will rise from 38% in 2025 to 58% in 2027, further encouraging manufacturers to electrify their line-ups. Long-term industry commitment is underscored by the China Society of Automotive Engineers’ [Industrial Roadmap 3.0](#), which sets EV sales shares targets for new LDVs of at least 80% by 2035 and 85% by 2040. To ensure that charging infrastructure grows in line with EV uptake, the government has announced [a 3-year plan](#) for 2025-27 to meet the demand of more than 80 million EVs by end of 2027, prioritising faster chargers, expanding charging in rural areas and improving vehicle grid integration. In addition to direct supply and demand-side measures supporting EV deployment, China’s [15th Five-Year Plan](#) emphasises enhancing energy security through diversification away from fossil fuels, supports system-wide electrification and the construction of zero-emission transportation corridors.

Over the past decade, sales of electric 2/3Ws have grown significantly, and by 2025, 50% of 2/3Ws were electric. In the STEPS, continued momentum, combined with further declines in battery prices, pushes the electric share of the 2/3W sales share close to 95% by 2035.

Electrification of trucks has gained pace over the past 2 years, supported by the [favourable total cost of ownership](#) (TCO) in many applications, trade-in policy, more stringent fuel economy standards for heavy-duty vehicles (HDVs), and sector-specific targets for certain [heavy industries](#) to switch to zero-emissions HDVs. Although upfront purchase prices for electric trucks remain higher than for diesel models, significantly lower running costs improve the TCO, making electric medium and heavy freight trucks cost-competitive in many applications in China. Additionally, support for faster charging infrastructure and grid impact mitigation, and the [increasing availability](#) of battery-swap-capable vehicles, supports further electrification, especially in segments that cannot fully rely on depot charging. By 2035 in the STEPS, electric trucks approach 60% of sales, and the same is true in the CPS, thanks to the competitive TCO in certain applications.

Electric buses are also progressing under increasingly stringent fuel-economy standards and a trade-in policy that continued into 2026. To date, electrification has been concentrated in cities, where nearly all new urban buses are now electric. However, [electric coaches](#) for intercity transport accounted for less than 10% of sales in 2025. In the STEPS, the electric share of bus sales reaches about 80% across all segments by 2035, up from 60% today.

The EV sales share across all vehicle types in China reaches over 90% by 2035 in both the CPS and the STEPS. This aligns with China’s priorities to reduce fossil

fuel imports, enhancing energy security, while also delivering co-benefits for air pollution reduction and supporting climate neutrality by 2060.

**Figure 9.4 Electric vehicle sales share by mode and scenario in China, 2025 and 2035**

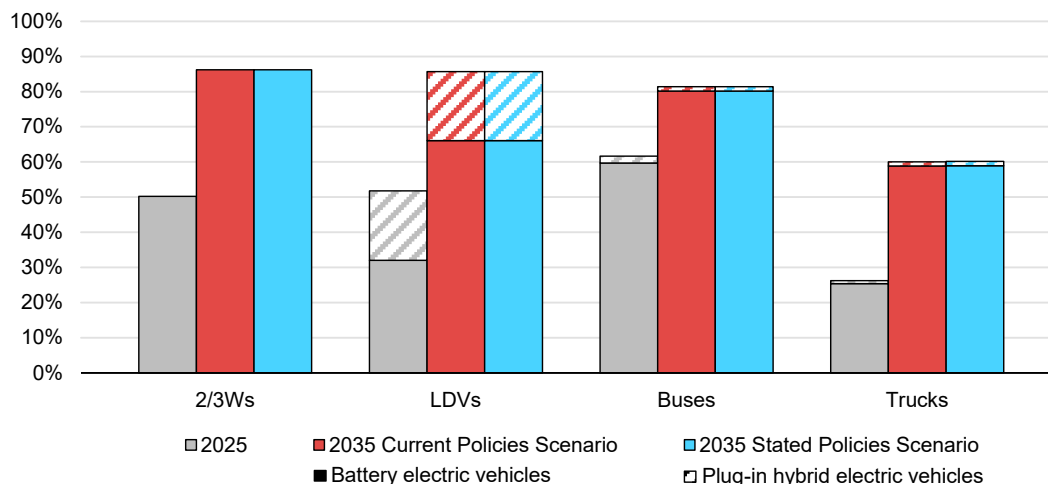

IEA. CC BY 4.0.

Notes: 2/3Ws = two- and three-wheelers; LDVs = light-duty vehicles. Regional projected EV sales and sales shares data can be explored in the interactive [Global EV Data Explorer](#).

## European policies continue to support the transition to EVs, while introducing some flexibilities

In 2025, the EU [CO<sub>2</sub> standards for cars and vans](#) entered a new phase, targeting a 15% reduction in CO<sub>2</sub> emissions from new sales compared to 2021 levels. As a result, electric car sales grew 30% in 2025, supported in part by the continuation, or – in some cases – the reintroduction of purchase subsidies in various countries (see [Chapter 1](#)). In addition, electric truck sales increased in 2025, as the [EU HDV CO<sub>2</sub> standards](#) require HDVs registered between July 2025 and June 2026 to achieve a 15% emissions reduction, compared to the same period from 2019-20.

In December 2025, the European Commission presented its [Automotive Package](#) proposal, which aims to increase flexibility in CO<sub>2</sub> standards, support EU industrial competitiveness, and accelerate enabling technologies (i.e. battery technologies). The proposal's key measures include a technology-neutral CO<sub>2</sub> reductions target for passenger cars, reducing the 2035 goal from 100% to 90%,<sup>43</sup> allowing conventional vehicles to be sold alongside battery and fuel cell electric cars, with the remaining 10% offset through the use of low-carbon steel made in the European Union and e-fuels and biofuels. The package also includes the [Automotive Omnibus](#), which introduces a new vehicle category under “Small

<sup>43</sup> This target seeks to achieve a 90% reduction in tailpipe emissions from new cars and vans sold in the European Union by 2035, compared with 2021 levels.

Affordable Cars”, covering EVs up to 4.2 metres in length. Manufacture of small, affordable electric cars [in the European Union](#) is incentivised by the generation of super-credits between 2030 and 2034 to support compliance with the CO<sub>2</sub> emissions standards (Box 2.4).

The proposed changes also include revising the CO<sub>2</sub> emissions reduction targets for vans down from a 50% reduction to a 40% reduction by 2030 compared to 2021 levels. In addition, the proposal aims to accelerate the uptake of zero-emissions vehicles in [corporate fleets](#), which represent up to 60% of new car and 90% of new van registrations in the European Union. Mandatory targets will be differentiated by member state and will start in 2030. The part of the [proposal](#) relating to the targeted amendment for HDVs has already been adopted, and provides flexibility that introduces stronger incentives for the early deployment of electric trucks, thereby easing compliance with the 2030 targets.

### **Box 9.2 Impact of the Automotive Package proposal on demand for “low-carbon” steel made in the European Union**

A recently proposed amendment to EU CO<sub>2</sub> standards for cars and vans would allow vehicle manufacturers to offset part of the emissions of their fleets by earning credits, from 2035, for using “low-carbon” steel produced within the European Union. Under the proposal, the average emissions of new sales for each manufacturer in 2035 can be up to 11 g CO<sub>2</sub>/km for cars and 14.7 g CO<sub>2</sub>/km for vans (a 90% reduction compared to the 2021 baseline), if the remaining emissions are offset by credits for the use of low-carbon steel and renewable fuels. “Low-carbon” steel credits can offset up to 7.7 g CO<sub>2</sub>/km for each new car and 10.3 g CO<sub>2</sub>/km for each new van, enabling manufacturers to compensate as much as 1.85 tonnes of CO<sub>2</sub>/car and 3.1 tonnes of CO<sub>2</sub>/van sold, based on the regulation’s assumed average lifetime mileage of 240 000 km for cars and 300 000 km for vans.

The volume of “low-carbon” steel that this measure could mobilise will depend on annual new vehicle registrations, and on the difference between the emissions intensity benchmark for conventional steel and the threshold that is adopted for “low-carbon” steel. The European Commission has indicated in the [Industrial Accelerator Act](#) that the conditions for defining “low-carbon” steel will be set in delegated acts under the Ecodesign for Sustainable Products Regulation (ESPR), while the emissions intensity benchmark for conventional steel has not yet been established.

Assuming that all vehicle manufacturers make full use of the available credits, the proposed Automotive Package could generate between 9 and 23 Mt of demand for EU-produced “low-carbon” steel by 2035. This corresponds to 7–17% of projected overall EU crude steel production in 2035 in the STEPS. In this analysis,

annual new car registrations are assumed to reach around 11 million in 2035 and new van registrations around 1.35 million, in line with projected numbers in the STEPS.

Given the uncertainty around what the emissions intensity definitions for “low-carbon” steel in the final legislation will be, as well as the benchmark for conventional steel, both a *low-demand* and a *high-demand* case are presented to explore a range of possible outcomes. The *low-demand* case assumes a large gap between the benchmark for conventional steel at 2.95 t CO<sub>2</sub>/t crude steel and a “low-carbon” steel threshold of 0.35 t CO<sub>2</sub>/t crude steel (i.e. the IEA’s global [reference emissions intensity value](#) for the blast furnace and basic oxygen furnace (BF-BOF) route, which is the most-used, and IEA’s near-zero emissions threshold with 15% scrap use). The *high-demand* case assumes a narrower gap between conventional steel production at 1.85 t CO<sub>2</sub>/t crude steel and “low-carbon” steel production at 0.8 t CO<sub>2</sub>/t crude steel (i.e. the EU average emissions intensity for BF-BOF and for natural gas-based direct reduced iron production [estimated by the German Environment Agency](#)).

**Maximum amount of “low-carbon” crude steel demand implied by the proposed Automotive Package, near-zero emissions steel demand commitments and announced projects in the European Union**

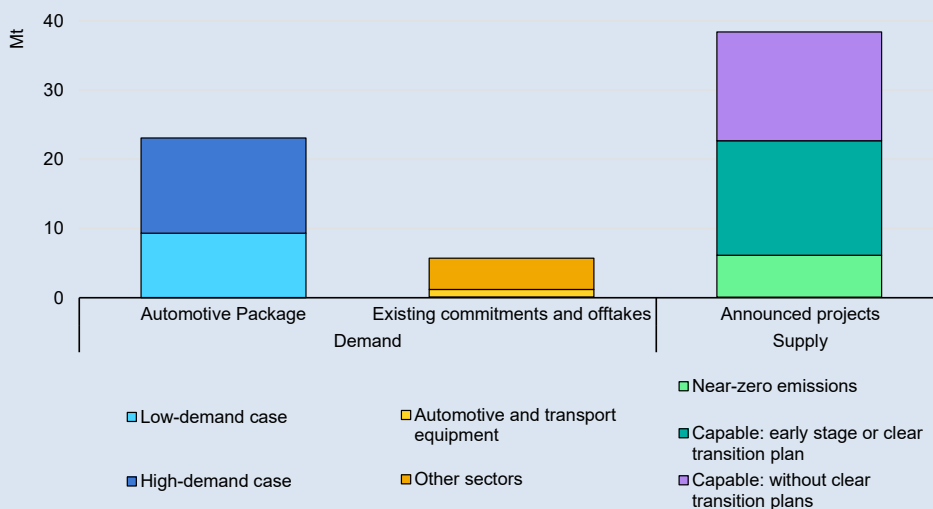

IEA. CC BY 4.0.

Notes: Steel demand implied by the Automotive Package refers to crude steel volumes: the actual quantity that ends up in cars and vans would be lower due to manufacturing losses. Near-zero emissions steel projects operate as near-zero emissions from the start; have achieved a final investment decision (FID) or provided strong certainty that FID will be achieved; and include clear information confirming near-zero emissions production. Capable refers to “near-zero emissions capable” projects. These are projects that would be designed with technical capabilities that enable near-zero emissions production in the future without substantial additional capital investments in core process equipment, but that would initially fall short of the emissions intensity required for near-zero emissions. Projects that have not achieved an FID, or are not near achieving one, are also included in the *capable* category due to greater uncertainty. The definition of near-zero emissions used is steel production that is compatible with the end-point of a net zero emissions pathway such as the IEA’s NZE Scenario as proposed in IEA’s [Achieving Net Zero Heavy Industry Sectors in G7 Members](#).

Source: IEA analysis based on public announcements.

Current publicly announced demand commitments and offtake agreements for near-zero emissions steel in the European Union amount to almost 6 Mt, of which around 1 Mt is linked to automotive manufacturers and suppliers. However, the majority of agreements have been signed without publicly disclosed volumes, and so actual demand could be higher. The proposed Automotive Package therefore has the potential to expand demand for “low-carbon” steel for this industry beyond current commitments.

However, the final impact of the proposed package in de-risking “low-carbon” steel projects remains uncertain. In the *low-demand* case, which considers the more stringent end-point emissions intensity, the estimated induced demand for “low-carbon” steel exceeds the roughly 6 Mt of near-zero emissions steel capacity currently announced in the European Union. In the *high-demand* case, the package could stimulate demand at a scale sufficient to support the advancement of a broader pipeline of projects, including some currently at earlier stages of development.

However a more lenient threshold for “low-carbon” steel that would increase the volume of steel eligible for credits, – while delivering the same emissions reductions – could weaken the business case for more innovative projects deploying deep decarbonisation technologies.

The remaining parts of the Automotive Package proposal will be negotiated in the European Parliament and the EU Council through trilogue talks, and until the legislative process is fully completed, the existing CO<sub>2</sub> emissions reduction targets for 2030 and 2035 remain in effect. Consequently, the proposed Automotive Package is reflected in the STEPS, while the current CO<sub>2</sub> emissions standards continue to apply in the CPS. Electric LDV sales shares grow from around 25% today in the European Union to over 90% by 2035 in the STEPS and nearly 100% in the CPS. In the STEPS, conventional cars, including hybrids, retain a market share of less than 10% beyond 2035, while the share of battery electric vehicles (BEVs) exceeds 85%. In the CPS, sales of battery electric LDVs approach 100% by 2035. For electric trucks, the sales share for both the STEPS and CPS reaches around 50% over the same period, given that the targeted amendment to the HDV CO<sub>2</sub> Regulation is reflected in both scenarios.

The trajectory of the EU market significantly influences the overall outlook for Europe, but other key markets, such as the United Kingdom and Türkiye, also play an important role.

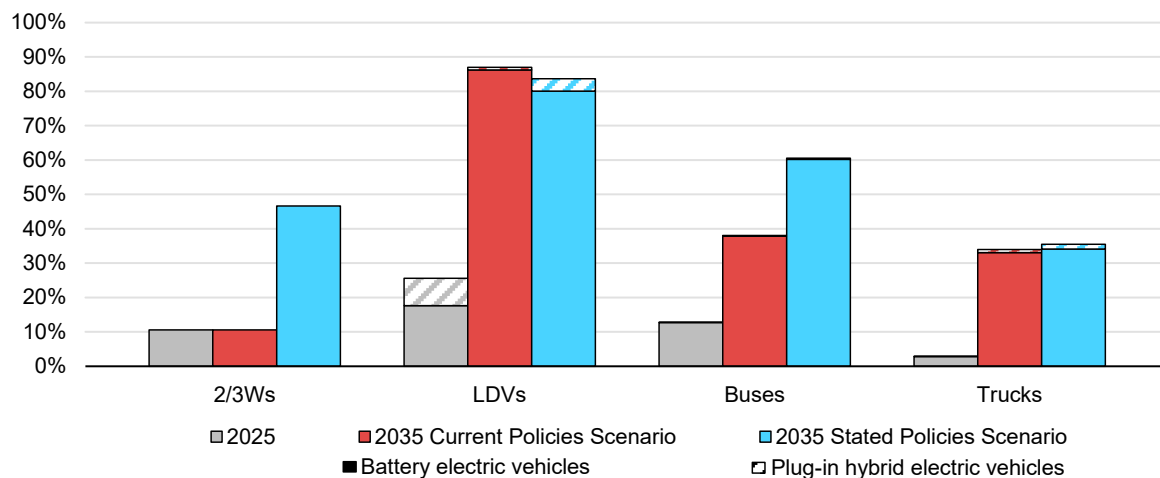
**Figure 9.5 Electric vehicle sales share by mode and scenario in Europe, 2025 and 2035**

IEA. CC BY 4.0.

Notes: 2/3Ws = two- and three-wheelers; LDVs = light-duty vehicles. Regional projected EV sales and sales shares data can be explored in the interactive [Global EV Data Explorer](#).

In the United Kingdom, the [Vehicle Emissions Trading Schemes](#) mandates sales of zero-emissions cars and vans. In 2035, 100% of sales must be battery electric or fuel cell vehicles. As such, electric LDV sales increase from one-third today to nearly 100% in 2035 both in the STEPS and the CPS.

Electric car sales also rise in the rest of Europe on aggregate, on the back of impressive momentum in large markets such as Türkiye. Although support varies a lot at the national level, strong policies in some countries drive Europe's sales share of electric cars and vans to around 90% in 2035 in the CPS and close to 85% in the STEPS, up from around 25% today.

For buses, medium and heavy freight trucks, the EU HDV CO<sub>2</sub> standards act as the primary lever for further electrification. Policy momentum for electric buses is particularly strong in the European Union, with their share of total bus sales reaching around 80% by 2035 in both CPS and STEPS, reflecting policies already in place and assumed in both scenarios. Stronger electrification of buses is further supported by a more optimistic outlook for European countries outside of the European Union under the STEPS scenario. In contrast, the CPS assumes more limited enabling conditions, such as charging infrastructure, which constrain EV deployment relative to STEPS. To meet EU HDV CO<sub>2</sub> standards, roughly 50% of new trucks sold in the European Union are electric in 2035 in both scenarios. In the United Kingdom, the electrification of trucks is supported by [emissions regulations](#) requiring a 30% emissions reduction by 2030 compared to 2019 levels. As such, around one-third of new medium and heavy freight trucks sold in the United Kingdom are electric by 2035 in both the STEPS and the CPS, up from 6%

today. Across Europe as a whole, the share of electric trucks reaches about 35% by 2035 in the STEPS, reflecting differences in policy ambition across countries.

Overall, electric sales across all vehicle types (excluding 2/3Ws) in Europe reach over 80% by 2035 in the STEPS, with passenger cars representing the bulk of sales, while the CPS assumes stronger growth at more than 85% under current policies; the impact of flexibilities is not included in the latter scenario.

## In the United States, waning regulatory support for EVs holds back adoption

Over the course of 2025 and the beginning of 2026, a number of US government actions worked towards the directions given in the [Executive Order 14154](#), which declared that it was US policy to, among other things, eliminate subsidies and other policy measures influencing markets in favour of EVs. The One Big Beautiful Bill Act (OBBBA) [ended](#) several federal programmes supporting EVs and EV charging infrastructure. This included ending the tax credits for new and used clean cars, as well as commercial vehicles, after 30 September 2025. The OBBBA also eliminated civil penalties for non-compliance with the corporate average fuel economy standards, and the [SAFE III Vehicles Rule](#) proposed by the US National Highway Traffic and Safety Administration in December 2025 does not count fuel efficiency benefits of EVs. In addition, in February 2026, the US Environmental Protection Agency finalised its [rescission](#) of the 2009 Greenhouse Gas Endangerment Finding, effectively repealing the GHG emission standards regulations for light-, medium- and heavy-duty vehicles. Previously, California had been granted waivers to set its own more ambitious vehicle emissions standards through the Advanced Clean Cars II and Advanced Clean Trucks regulations, but these were [revoked](#) in June 2025 through Congressional Review Act resolutions. As a result, regulatory support for EV sales has been weakened both at the federal and state levels over the past year and into the foreseeable future.

In addition, US federal government funding for EV charging infrastructure is largely due to end in 2026. Following the OBBBA, the [Alternative Fuel Vehicle Refuelling Property Credit](#), which provides a tax credit of up to USD 1 000 per charging port for the installation of eligible residential chargers, will end after June 2026. In addition, 2026 will be the final year of the [National Electric Vehicle Infrastructure \(NEVI\) Funding Program](#), which has an allocation of USD 5 billion (from fiscal year 2022 to 2026) to support the deployment of EV charging infrastructure along highway corridors. However, new NEVI-funded stations should continue to come online over the next few years, further enabling long-distance trips in EVs. This is in addition to private investment, which has historically accounted for the majority of investment in fast charging stations.

In the CPS, the adoption of EVs is constrained by the absence of continued policy support, in particular the lack of enforceable, stringent fuel economy standards. In addition, EVs are currently priced higher, on average, than conventional vehicles in the United States. Given that the CPS takes a conservative view of technology price declines, EV sales shares stagnate around today’s levels in the United States in this scenario. In the CPS, the EV sales share across all modes (excluding 2/3Ws) remains less than 10% throughout the projection window.

**Figure 9.6 Electric vehicle sales share by mode and scenario in the United States, 2025 and 2035**

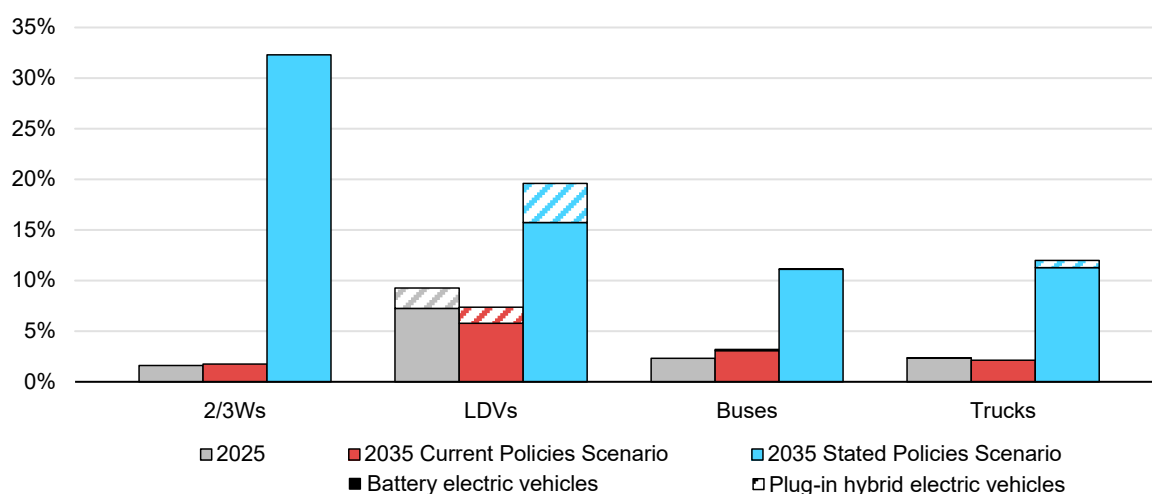

IEA. CC BY 4.0.

Notes: 2/3Ws = two- and three-wheelers; LDVs = light-duty vehicles. Regional projected EV sales and sales shares data can be explored in the interactive [Global EV Data Explorer](#).

In the STEPS, electric car sales in the United States grow on average around 7% per year from 2025 levels to 2035 (about one-fifth of the average growth rate observed from 2020 to 2025), reaching around one-fifth of car sales in 2035. Electric car sales in the STEPS are driven by technology and cost improvements that attract new consumers despite the lack of EV-related policy support. There is room for electric car adoption to continue to grow in the United States: over half of US households have [more than one car](#), meaning that switching to an EV in place of one of the gasoline cars could have [little to no impact](#) on driving habits for such households. According to [survey data](#), the share of US consumers planning to purchase an EV as their next car is growing, and reached 29% in 2025; however, about one-third of US respondents plan to never switch to an electric car.

Although US electric car production and sales are expected to fall in 2026, [production forecasts](#) show a rebound thereafter, with production increasing on average around 25% per year to the end of the decade. Around 20 automaker groups are looking to produce and launch new electric car models in the United States, especially extended-range EVs (EREVs).

Trucks reach lower electrification rates than cars, but gain momentum in the 2030s as the [total cost of ownership](#) (TCO) improves relative to conventional trucks. In the STEPS, more than one in ten trucks sold in 2035 is electric. Electric bus sales in the STEPS increase as state and local governments continue to support and finance the higher upfront costs of electric buses compared to conventional buses, in order to benefit from lifetime cost savings, as well as benefits for air quality. The EV sales share across all modes (excluding 2/3Ws) reaches 11% in 2030 and around 20% in 2035, up from 9% in 2025.

## India's EV policy support targets commercial fleets, as electrification of 2/3-wheelers and cars gains momentum

In 2024, India introduced the PM Electric Drive Revolution in Innovative Vehicle Enhancement ([PM E-DRIVE](#)) scheme to support the uptake of electric 2/3Ws, buses, trucks and charging infrastructure. The scheme was originally allocated a budget of around USD 1.2 billion between 1 October 2024 and 31 March 2026. However, in January 2026, the scheme's end date was [extended](#) until 31 March 2028 for all vehicle types except some electric 3Ws. For electric 2Ws, the extension was limited to 31 July 2026. The aims of the scheme for electric 3W sales have already been [met](#), as the segment passed a 60% annual electric sales share for the first time in 2025. The market penetration of electric 2Ws reached 6% in 2025. As such, the 2/3W segment is the most electrified in India today, with a 10% market share.

Thanks to electric 2/3Ws, India's EV sales surpassed 2 million for the second year in a row in 2025. Despite the reduction in policy support, advantageous economics, especially for [3Ws](#), sustain momentum for electric 2/3W sales, which reach a sales share of around 60% by 2035 in the STEPS. However, in the CPS, in which barriers around EV adoption and electromobility infrastructure are assumed to increase when India's EV policies come to an end, this share instead reaches 20%.

Although India does not offer direct purchase subsidies for electric cars, it supports their adoption through other measures, primarily various [tax reductions](#). India also promotes domestic EV and battery production through [Production Linked Incentive](#) schemes for the automotive and battery industries. In addition, the government also has a [plan](#) to attract global EV manufacturers to invest in electric car manufacturing in India (see [Chapter 7](#)). Recent market dynamics show strong momentum, with electric car sales in India increasing by around 80% last year and reaching a 4% sales share for the first time in 2025. The increasing momentum and improving affordability of electric cars continues in the STEPS, with electric LDVs reaching a sales share of nearly 25%, or over 2 million cars and vans, by 2035 in this scenario, up from 3% in 2025, with nearly all EV sales being BEVs – in line with historical trends. In the CPS, the share increases only slightly to 5% by

2035 as EV policies are not assumed to continue after their specified periods, and deployment of charging infrastructure struggles to expand.

In addition to the PM E-DRIVE target to support the uptake of 14 000 electric buses with purchase subsidies, India also adopted the [PM e-Bus Sewa-PSM](#) scheme in 2024, to support the rollout of an additional 38 000 electric buses over a 4-year period by ensuring monthly payment obligations for bus operators. In 2025, the government introduced its first-ever electric [truck incentive scheme](#) (as part of PM E-DRIVE) to support the uptake of 5 600 electric trucks. The scheme provides around USD 10 000 per electric truck purchase. However, the planned rollout will take time to start making an impact on India's HDVs, considering there were a total of around 100 000 buses and 420 000 trucks sold in 2025 alone. In 2025, sales shares for electric buses and trucks stood at around 4% and less than 0.5%, respectively. However, when support from the numerous schemes is taken into account, electric bus sales reach 55% in 2035 in the STEPS. Electrification of trucks stagnates by comparison, due greater price barriers, reaching 3% in 2035 in the STEPS. In the CPS, the share of electric buses increases more slowly, to below 10% by 2035, while electric truck sales remain similar to today's.

**Figure 9.7 Electric vehicle sales share by mode and scenario in India, 2025 and 2035**

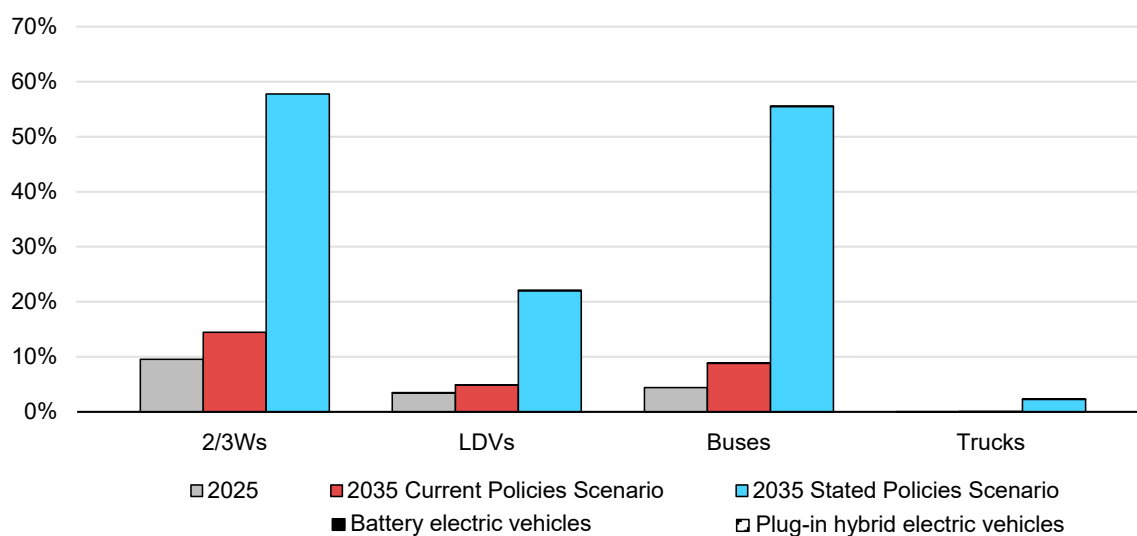

IEA. CC BY 4.0.

Notes: 2/3Ws = two/three-wheelers; LDVs = light-duty vehicles. Regional projected EV sales and sales shares data can be explored in the interactive [Global EV Data Explorer](#).

Across all vehicle modes, excluding 2/3Ws, EVs represent 1 in 4 vehicles sold in India in 2035 in the STEPS, up from less than 1 in 30 in 2025. In the CPS, 1 in 20 vehicles sold is electric by 2035. When 2/3Ws are included, stated policies imply that almost every second vehicle sold by 2035 is electric. In the CPS, the share reaches 15% by 2035.

## EV growth in Japan and Korea is driven by demand-side support policies and supply-side mandates

In **Japan**, the LDV fuel economy [standard](#) first introduced in 2019 will take EVs into consideration from 2030. This targets an improvement of around 25% in fuel economy by 2030 compared to 2016, with consumption measured in litres per 100 km, taking into account well-to-tank energy consumption. In 2025, purchase [subsidies](#) for electric cars were increased to further support the push towards electromobility and meet the country's [Green Growth Strategy](#), which aims for 100% of car sales to be “electrified” (i.e. BEV, plug-in hybrid electric vehicle [PHEV], fuel cell electric vehicle [FCEV] or hybrid electric vehicle [HEV]) by 2035, and to achieve the same for light commercial vehicles (LCVs) by 2040. Added to these measures, seven large Japanese automakers have electrification targets in place, driving the electric LDV sales share to around 20% by 2035 in the STEPS, up from 2.5% today. Given that Japan's fuel economy standard does not have any targets beyond 2030, EV sales stagnate at around 2030 levels in the CPS, resulting in an electric sales share of just over 10% by 2035.

Japan also has purchase [subsidies](#) in place for commercial buses and trucks to support EV and FCEV uptake. In the STEPS, electric bus sales reach about 30% by 2035, up from 2% in 2025, while electric heavy-duty truck sales continue to be slow but nonetheless rise from almost none today to over 10% by 2035. In the CPS, electrification of trucks does not advance further from today's levels.

By contrast, Japan is already moving at pace towards the electrification of 2/3Ws, with electric 2/3Ws accounting for 8% of sales in 2025. This is supported by Tokyo's [subsidies](#) for 2/3Ws, as the city [aims](#) to achieve CO<sub>2</sub>-free motorcycle sales by 2035. Electrification of the segment is further enabled by the strong 2W manufacturing expertise of domestic incumbent original equipment manufacturers (OEMs) such as Honda, Yamaha, Kawasaki and Suzuki, all of which offer electric models. The share of electric 2/3Ws rises further in the STEPS, reaching nearly 60% by 2035. In the CPS, the rise is far more muted, accounting for less than 15% of sales in the same year.

Japan's EV sales share across all modes (excluding 2/3Ws) was 2% in 2025, and this increases to just under 20% by 2035 in the STEPS, and above 20% when including 2/3Ws.

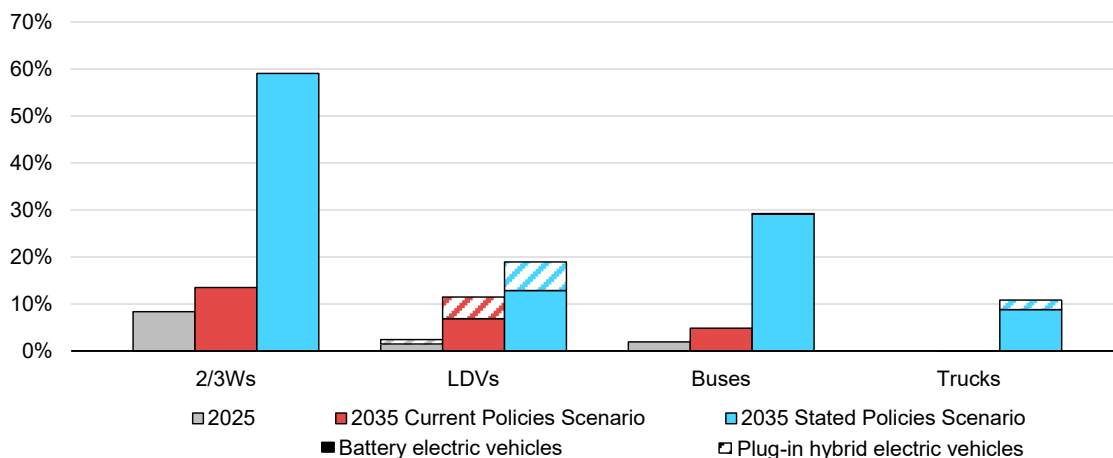
**Figure 9.8 Electric vehicle sales share by mode and scenario in Japan, 2025 and 2035**

IEA. CC BY 4.0.

Notes: 2/3Ws = two/three-wheelers; LDVs = light-duty vehicles. Regional projected EV sales and sales shares data can be explored in the interactive [Global EV Data Explorer](#).

In **Korea**, electric car sales grew by around 65% in 2025, exceeding 200 000 for the first time and breaking a 2-year period of stagnation. Major domestic manufacturers, including [Hyundai](#) and Kia, announced plans to introduce new BEV, EREV and hybrid models in 2026, further expanding their electrified model availability.

In January 2026, the government introduced new [targets for low- and zero-emissions vehicles](#). The targets for low-emissions vehicle sales, which includes BEVs, FCEVs and PHEVs, increase from 28% in 2026 to 50% by 2030. In parallel, manufacturers will be required to meet zero-emissions vehicle sales targets (BEVs and FCEVs) of 24% in 2026 and 50% by 2030. Both domestic and foreign manufacturers will face penalties if they fail to meet these targets.

In addition, the government announced an expansion of EV subsidies, with the budget increasing from around USD 535 million in 2025 to [USD 640 million](#) in 2026. Additional subsidies were introduced for electric LCVs and medium and heavy freight trucks, with support levels of around USD 10 000, USD 30 000 and USD 40 000, respectively. The government also introduced a vehicle [replacement incentive](#) of around USD 700 for consumers scrapping an ICE car and purchasing an EV, on top of existing EV purchase subsidies. The expanded subsidies support faster EV uptake in STEPS, and the EV share of LDVs reaches 60% by 2035.

Public investment in [charging infrastructure](#) has also been expanded. A budget of USD 375 million was allocated to deploy around 4 450 fast chargers and 65 000 slow chargers, bringing the total number of new charging points planned to about 71 450. This would expand the current stock of public charging points by around 15%. Furthermore, Korea is shifting its EV charging policy from expanding

installations to improving charger quality, introducing stricter standards and new evaluation criteria for both operators and manufacturers. In addition, the government announced a new [USD 100 million](#) private-public investment fund to support battery and fuel cell electric vehicles, including V2G integration.

In the CPS, the absence of fuel economy standards for HDVs slows the electrification of buses and trucks, whereas continued technology improvements and cost declines drive higher EV sales in the STEPS. In the STEPS, Korea’s total EV sales surpass 1 million units by 2030, more than four times higher than in 2025. Sales reach similar, albeit slightly lower, levels in the CPS, reflecting lower uptake of medium- and heavy-duty trucks.

**Figure 9.9 Electric vehicle sales share by mode and scenario in Korea, 2025 and 2035**

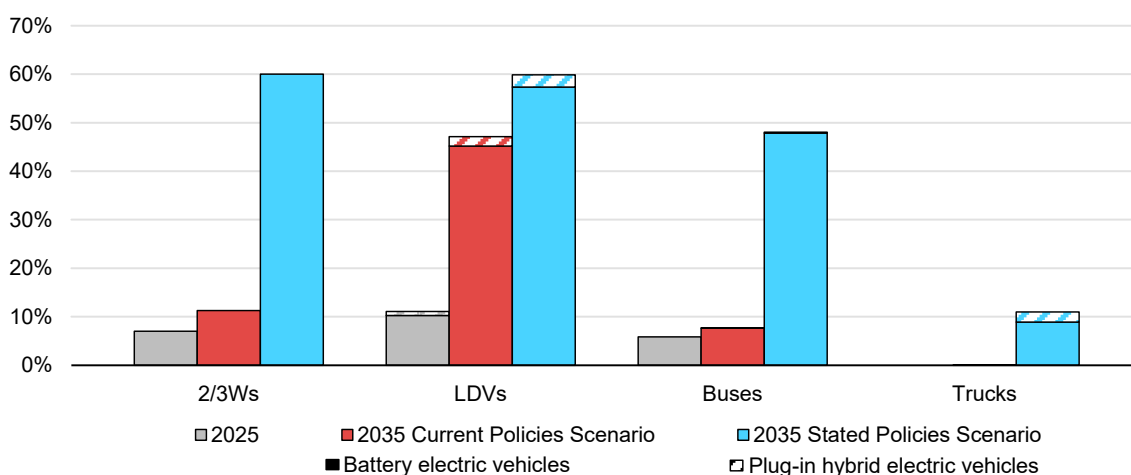

IEA. CC BY 4.0.

Notes: 2/3Ws = two/three-wheelers; LDVs = light-duty vehicles. Regional projected EV sales and sales shares data can be explored in the interactive [Global EV Data Explorer](#).

## Southeast Asia’s outlook is brightened by strong local manufacturing and EV policies

Governments across Southeast Asia support EV adoption through a mix of fiscal incentives, trade policies and local manufacturing requirements. Recently, policy frameworks across the region have increasingly shifted towards encouraging EV adoption through domestic manufacturing. In 2026, countries such as Malaysia (the largest car market in the region), Indonesia (second-largest) and Thailand (third-largest) ended import duty exemptions that had previously supported early adoption. At the same time, these countries maintained significant registration tax relief for electric cars (as well as purchase subsidies in Thailand) while linking incentives more closely to local content requirements. Although these policy changes may weaken the short-term outlook for electric car sales by reducing the price competitiveness of Chinese imports, they are expected to

support adoption by increasing local production over the longer term (see [Chapter 7](#)). These countries’ cost advantages, including relatively low labour and energy costs, could strengthen their EV manufacturing cost-competitiveness and support broader adoption, thanks to the affordability of available EVs, similarly to what has been observed in recent years.

The electric car sales outlook is uneven across markets. In **Malaysia**, the remaining price gap between electric cars and conventional alternatives (see Figure 2.7) constrains wider adoption in the CPS, with sales shares remaining around current levels. In the STEPS, however, stronger policy signals and cost-competitive local manufacturing support higher uptake, with sales shares exceeding 40% by 2035. In **Thailand**, purchase price parity, combined with competitive local production and strong policy support (see Table 2.1), underpins robust adoption, with sales shares approaching 60% by 2035 in both scenarios. In contrast, persistent price premiums in **Indonesia** weigh on uptake in the CPS, with sales shares remaining close to 2026 levels. In the STEPS, existing policy support helps narrow the price gap, pushing adoption above 50% by 2035. In the **Philippines**, continued reliance on import duty and excise tax exemptions supports adoption in the near term. Despite limited affordability constraining wider adoption in the CPS, electric cars could reach around 45% of sales in the STEPS by 2035.

**Figure 9.10 Electric car sales share by country in Southeast Asia, 2025 and 2035**

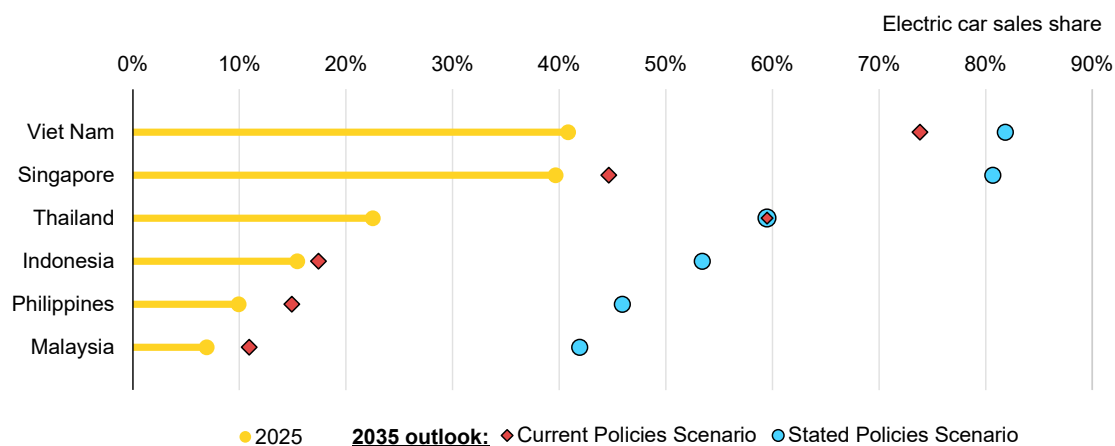

IEA. CC BY 4.0.

Other Southeast Asian markets are set to continue to rely primarily on registration tax incentives. **Viet Nam** supports EV adoption through registration fee rebates and already shows strong price competitiveness for electric cars. As a result, sales shares are projected to reach nearly 75% by 2035 in the CPS. Ongoing discussions to [extend](#) the rebate end date from 2027 to the end of 2030, amid the oil price pressures resulting from the Middle East crisis, further strengthen uptake

in the STEPS, with sales shares exceeding 80% by 2035. Similarly, **Singapore** focuses on hefty tax exemptions or surcharges to drive its road transport transition, supporting EV sales shares of close to 80% by 2035 in the STEPS, while price premiums constrain uptake in the CPS.

Overall, the evolving policy, industry and market landscape across Southeast Asia supports a strong regional outlook. In the STEPS, electric car sales in Southeast Asia reach 40% of total car sales by 2030 and approach 60% by 2035, up from close to 20% in 2025. In the CPS, where policies expire as scheduled and upfront affordability weighs on uptake, sales shares remain lower, standing around 35% by 2035.

Electric 2/3W adoption is supported by several policy measures across the region, as outlined in Table 2.1. Malaysia is [discussing](#) the extension of its MARiCAS rebate programme to 2026, and Indonesia is likely to [reinstate](#) purchase subsidies. In addition, the increasing affordability of electric models relative to their conventional equivalents further supports adoption. As a result, in the STEPS, strong momentum in electric 2/3W sales is maintained across the region, with adoption expected to reach 45% by 2035, up from around 6% in 2025. In the CPS, where Malaysia's and Indonesia's electric 2/3W support policies are not assumed to be renewed in 2026 and Thailand's EV3.5 scheme expires as planned after 2027, adoption is projected to be much slower, reaching around 25% by 2035.

**Table 9.1 Electric vehicle policy frameworks in Southeast Asia**

Country	EV incentives	Trade policies	Local manufacturing requirements
<b>Indonesia</b>	10% VAT <a href="#">discount</a> on BEVs <a href="#">ended</a> in December 2025. Reduced annual vehicle tax ( <a href="#">PKB</a> ) in selected regions. 15% luxury tax <a href="#">rebate</a> for BEVs meeting local content requirements.	Import duty exemptions on CBU BEVs <a href="#">ended</a> in December 2025.	Carmakers that benefited from tariff exemptions must commit to local production with increasing local content through 2027.
<b>Malaysia</b>	Favourable <a href="#">annual road tax</a> framework for electric cars. <a href="#">MARiCAS</a> rebate programme for 2/3Ws (ended in 2025). Government procurement of 1 000 <a href="#">electric buses</a> by 2030.	In 2026, CBU EVs are no longer exempt from import duties and subject to <a href="#">minimum import price</a> .	Policies designed to encourage <a href="#">local CKD assembly</a> through import duty reliefs on vehicle parts and components.
<b>Thailand</b>	- CO <sub>2</sub> -emission-based <a href="#">excise tax system</a> introduced in 2026. <a href="#">EV3.5 scheme</a> : Indirect purchase subsidies and purchase tax breaks for electric cars and 2/3Ws.	Import duty reliefs ended in December 2025.	In 2025, EV3.5 <a href="#">tightened</a> local production requirements for eligibility to excise tax relief and for OEMs that had benefited from import duty reliefs over 2024-25.

Country	EV incentives	Trade policies	Local manufacturing requirements
<b>Philippines</b>	Excise tax <a href="#">exemption</a> for EVs.	<a href="#">Import tariff exemption</a> running until 2028.	Electric Vehicle Incentive Strategy ( <a href="#">EVIS</a> ) will provide incentives that stimulate local production of EVs, batteries, components and charging stations.
<b>Viet Nam</b>	<p><a href="#">Excise tax</a> rebates for BEVs (possibly <a href="#">extended</a> from 2027 to 2030).</p> <p><a href="#">Registration fee</a> exemption for BEVs (possibly <a href="#">extended</a> from 2027 to 2030).</p> <p>Gasoline 2/3Ws banned from <a href="#">Hanoi</a> from 2026 and <a href="#">Ho Chi Minh City</a> from 2027.</p>	ASEAN-origin EVs benefit from tariff exemptions under regional FTA.	Corporate income tax <a href="#">breaks</a> for EV makers and import duty exemptions on EV parts and manufacturing equipment. No local content requirements.
<b>Singapore</b>	<p>Car registration fee relief or surcharges through <a href="#">Vehicle Emissions Schemes (VES)</a> and <a href="#">EV Early Adoption Incentive</a> schemes.</p> <p>Scrappage schemes for LCVs (<a href="#">CVES</a>) and HDVs (<a href="#">HVZES</a>).</p>	-	-

Notes: BEV = battery electric vehicle; 2/3W = two/three-wheeler; EV = electric vehicle; LCV = light commercial vehicle; HDV = heavy-duty vehicle, including buses and trucks; CBU = completely built-up; FTA = free trade agreement; CKD = completely knockdown; OEM = original equipment manufacturer.

Policy support for HDVs, such as buses and trucks, is far more limited than support for LDV modes across the region. Apart from Singapore, which introduced strong incentives for commercial EVs through scrappage schemes, and city-level bus electrification [programmes](#) in Viet Nam, most Southeast Asian countries lack clear policy frameworks to support the adoption of electric HDVs. As a result, the outlook for electric buses and trucks is not as upbeat as for other vehicle modes. In the STEPS, electric buses reach about one-third of total sales by 2035, while electric trucks remain well below the 5% adoption mark. In the CPS, where slower charging infrastructure deployment represents a significant hurdle to EV adoption, the outlook is weaker for both electric buses and trucks, with 2035 sales shares at 5% and below 1%, respectively.

Overall, across all vehicle types excluding 2/3 wheelers, the EV sales share in Southeast Asia approaches 50% in 2035 in the STEPS, while adoption is much slower in the CPS, reaching nearly 30% over the same period.

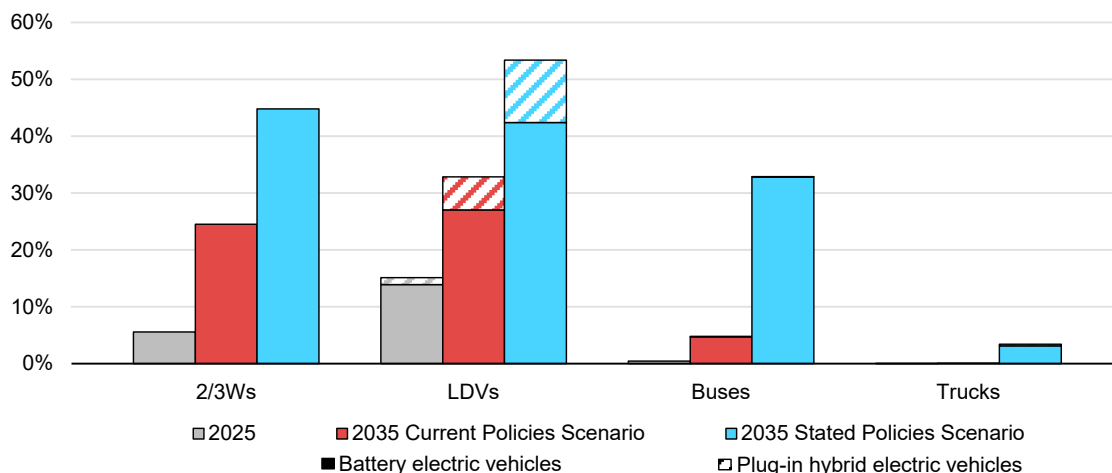
**Figure 9.11 Electric vehicle sales share by mode and scenario in Southeast Asia, 2025 and 2035**

IEA. CC BY 4.0.

Notes: 2/3Ws = two/three-wheelers; LDVs = light-duty vehicles. Regional projected EV sales and sales shares data can be explored in the interactive [Global EV Data Explorer](#).

## Policy support drives electric car and bus uptake in Latin America

Countries in Latin America have increased their policy support for EVs in recent years, especially since 2020. **Brazil, Colombia, Chile** and **Mexico** stand out for passing legislation to promote EVs. These countries are particularly important for defining the EV outlook for the region, as together they represent more than three-quarters of Latin America's car and bus sales. Beyond these larger markets, most Latin American countries have some EV support in place, typically in the form of exemptions from import or purchase taxes, which makes EVs more affordable.

As EV adoption in Latin America is mainly promoted through tax exemptions, rather than through strict fuel economy or emissions targets adopted into law, the sales share of EVs by 2035 in the CPS reaches just above 9% for cars and 5% for buses, factoring in challenges around charging infrastructure and affordability. In the STEPS, the share of electric car sales in Latin America increases from 7% in 2025 to reach around 25% in 2035 in the STEPS, reflecting the influence of existing industrial strategies, growing local manufacturing plans and continued policy momentum across key markets. The STEPS also assumes that electric cars become increasingly affordable over time, as battery prices are expected to continue decreasing, which also contributes to a more rapid expansion of electric mobility compared with the CPS.

In **Brazil**, the electric car sales share rises more modestly in the CPS, reaching around 12% by 2035. In contrast, the STEPS incorporates the full implementation and continued strengthening of Brazil's industrial and efficiency policies, such as

the [MOVER programme](#) that came into place in 2024, which incentivises private sector investment in the R&D and manufacturing of sustainable vehicle technologies including EVs. In 2025, adjustments were made to the MOVER programme to focus more on local manufacturing, such as the [phase-out](#) of the tariff exemption on imported electric cars at the start of 2026, and the [Sustainable Car initiative](#), which gives domestically manufactured electric cars tax rate reductions. These measures are reinforced by [Mission 3 of the Nova Indústria Brasil programme](#) (NIB), which strengthens domestic industrial capabilities and local EV value chains. By 2035, the build-out of local electric car manufacturing increases the electric car sales share to nearly 35% in the STEPS, up from 9% in 2025.

Latin America has also seen success in deploying electric buses, with sales tripling year-on-year in 2025. Uptake is expected to continue in the STEPS, as electric bus sales reach over 25% in 2035, up from less than 3% in 2025. **Chile** stands out in particular – with around [4 200 electric buses](#) on the road today, Santiago has become world’s third-largest operator of electric buses after the cities of Beijing and Shenzhen.

Overall, across all vehicle types excluding 2/3 wheelers, the EV sales share in Latin America reaches above 20% in 2035 in the STEPS. In the CPS, adoption is slower, reaching just 7% over the same period.

**Figure 9.12 Electric vehicle sales share by mode and scenario in Latin America, 2025 and 2035**

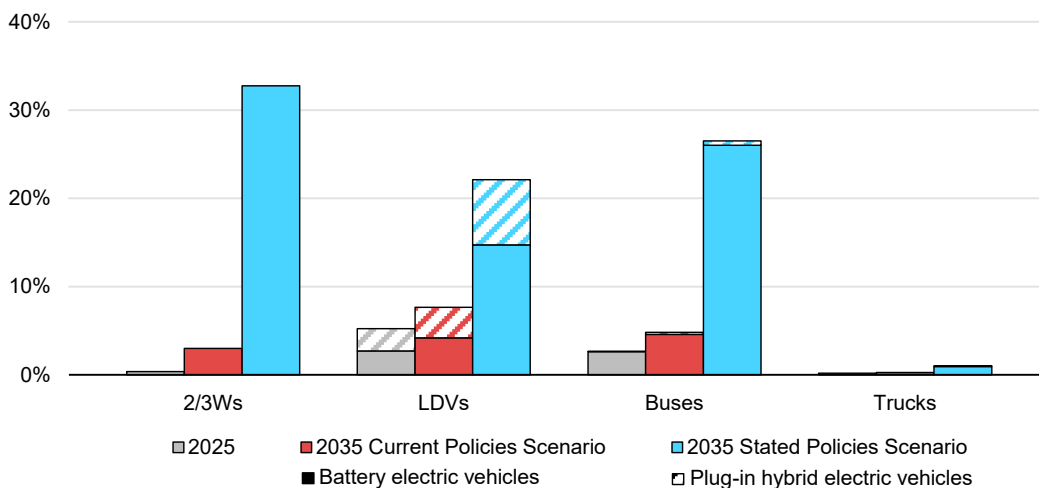

IEA. CC BY 4.0.

Notes: 2/3Ws = two/three-wheelers; LDVs = light-duty vehicles. Regional projected EV sales and sales shares data can be explored in the interactive [Global EV Data Explorer](#).

## Carmaker electrification announcements

In line with shifting policy momentum, incumbent carmakers in advanced economies continue to water down their electrification targets for the second year in a row, even as electric car sales hit new records in many regions across the world. By contrast, OEMs in China and many EMDEs appear more ambitious, buoyed by significant increases in electric car sales in these markets for the second year in a row.

The range of OEM declarations for electric car sales shares in the **United States** in 2030 now stretches from 25% to close to 70%. These shares take into account the scale-back in EV ambitions by General Motors (GM), Ford, Tesla, Honda and Nissan. In comparison, if electrification [declarations](#) made in 2021 at COP26 by GM, Ford, Mercedes-Benz, Volvo and others are also considered, the range of OEMs' 2035 electrification targets spans from 35% to as much as 85%, with the wide range reflecting automakers' uncertainty about the US market.

In **Europe**, the introduction of flexibility measures as part of the Automotive Package proposal have increased uncertainty in automakers' targets. This has resulted in the widening of OEM's targeted electrification range for Europe compared to last year's edition of the Global EV Outlook. Nevertheless, the range of OEM electrification targets for Europe remains the highest of all major EV markets, reaching from 55% to 90% of car sales in 2030, and from around 65% to over 95% in 2035. These shares take into account the reduction in EV ambitions by OEMs such as the Volkswagen Group, Mini, Bentley and Stellantis.

As a result of the growing success and ambition of pure-play EV makers, the EV sales shares in **China** in 2030 based on OEM targets range from 75% to more than 80%. These shares take into account the upward revision and acceleration of electric car sales targets by BYD, alongside ambitious growth targets set by Leapmotor, HIMA, Xpeng, Xiami, Li Auto, and Nio, as well as expanded electrification targets from traditional automakers including Geely, Changan, Dongfeng, and FAW Group. Since there is no domestic automaker with a target for beyond the end of this decade, the OEMs' shares range for China in 2035 do not differ much from 2030, and its production range is below the projected demand by 2035 in the STEPS.

**Figure 9.13 Range of electric car sales shares based on automaker electrification targets and electric car sales share by scenario, 2030**

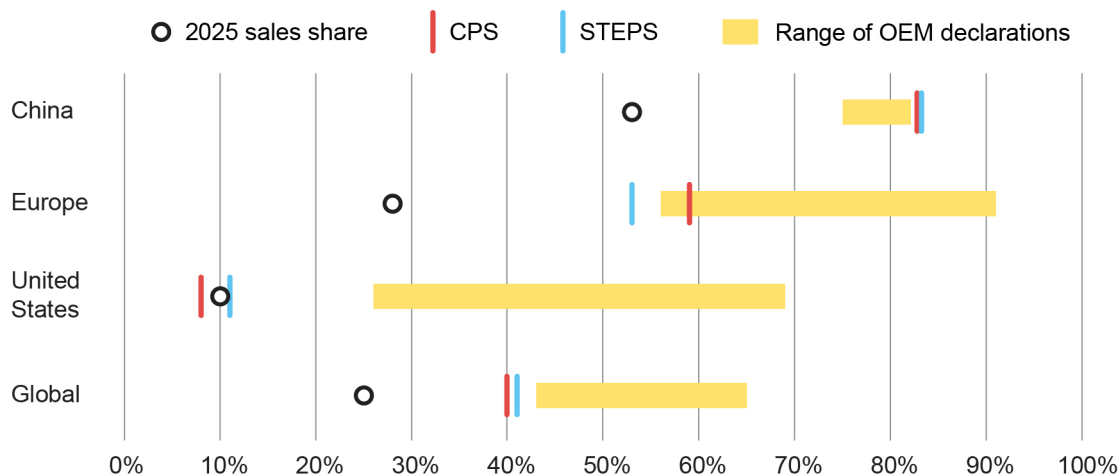

IEA. CC BY 4.0.

Notes: CPS = Current Policies Scenario; STEPS = Stated Policies Scenario; OEM = original equipment manufacturer. Range reflects OEM announcements as of the end of Q1 2026. The relative market share of OEMs is held constant unless the OEM has EV volume targets rather than sales share targets. Automaker electrification targets used for the analysis are included in [Annex G](#).

Sources: IEA analysis based on company announcements and data from [Marklines](#).

At the global level, the range of uncertainty in projected electric car sales increased by 5 percentage points from last year's edition of the Global EV Outlook. A widening of the targeted range in Europe was somewhat offset by rising ambition in China. The global electric car sales shares envisaged by OEMs for 2030 and 2035 remain similar, and stand at around 45% to 65%. At the global level, these trends have been affected by revisions from major Asian automakers. Hyundai has introduced greater flexibility in its electrification strategy, shifting its focus from BEVs to a broader mix of electrified powertrains (including hybrids). In addition, Kia has revised down its BEV sales target for 2030.

However, achieving even the lower end of this range would mean that the number of electric car sales in 2035 would be more than twice that of 2025 – well-aligned with the CPS projections for the period.

## Incumbent automakers in the United States and Europe scale back targets as EV policy shifts and profitability takes a hit

In the **United States**, automakers' targets have been influenced by stagnating electric car sales and waning policy support, particularly the elimination of tax credits for electric car buyers and the removal of penalties for not meeting fuel economy standards.

The United States’ largest OEM, GM, which manufactures over 6% of all cars globally, has reported a [USD 7.6 billion](#) write-down in 2025 and has scaled back EV production capacity. The company expects relatively [low 2026 sales](#) in the United States – its largest market – accounting for around half of all its car sales. After falling short of its 2024 sales and 2025 production targets for EVs, GM is investing [USD 4 billion](#) in both ICE and electric car manufacturing capacity expansion in the United States.

After reporting a [USD 19.5 billion](#) write-down (mostly EV related), Ford has cancelled the production of several electric models and decided to [water down](#) its 2030 target for 50% of global sales to be battery electric, by adding hybrids and EREVs into the target, as well as focusing more on low-cost models. These three powertrains accounted for 17% of Ford car sales globally in 2025.

Several OEMs are increasingly planning launches of EREVs as a way to increase EV sales in the United States. Volkswagen Group’s subsidiary and US EV market newcomer Scout has reported an impressive [150 000 preorders](#) for electric LDVs, with 85% of them being extended-range options.

**Figure 9.14 Car production by carmaker group and headquarters, 2025**

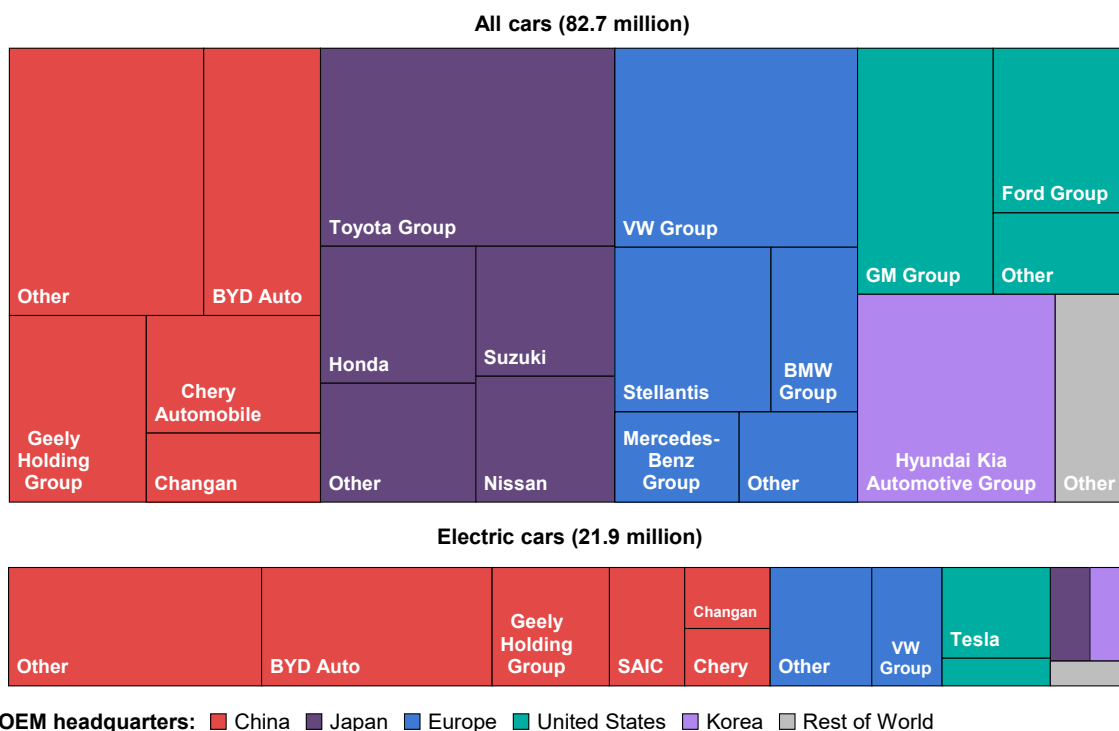

IEA. CC BY 4.0.

Note: OEM = original equipment manufacturer.

Sources: IEA analysis based on data from [MarkLines](#) and [Benchmark Mineral Intelligence](#).

Honda has [cancelled three EV models](#) planned for production in the United States, and is expecting losses of around [USD 16 billion](#) for restructuring its EV business. Nissan has also [postponed](#) the start of production of two electric SUVs at an assembly plant in the United States to 2028.

Tesla has now lost its position as the top-selling BEV maker in the world to China's BYD, with its battery electric car sales dropping 9% to 1.6 million in 2025, a 3-year low. If including PHEVs, BYD overtook Tesla in EV sales as early as 2022. Tesla has now decided to [discontinue](#) the production of both its Model X and Model S, shifting its focus to robots and AI. Another US-headquartered EV maker, Rivian, announced it would look for ways to [reduce costs](#) and bring its electric car models to mass market, as they can no longer depend on EV tax credits.

In **Europe**, the European Commission introduced flexibility measures in April 2025 to help automakers to meet [2025 CO<sub>2</sub> standards](#) for cars and vans, by averaging their performance for the 2025-27 period rather than annually. In December 2025, the proposed [EU Automotive Package](#) reduced the 2035 target to a 90% CO<sub>2</sub> emissions reduction based on cars sold and gave OEMs more flexibility measures to reach the target. The proposed 2030-32 averaging would also allow OEMs to maintain relatively lower electric car sales by 2030. Low-carbon steel and/or e-fuel and biofuel credits could allow automakers to meet CO<sub>2</sub> standards with relatively lower EV volumes compared to the original 2035 target, effectively reducing the role of EVs in the European Union's decarbonisation targets. These flexibilities have reverberated in OEMs electrification targets. Volkswagen Group, which produced nearly 10% of all cars globally in 2025, announced in December 2025 its plans to reduce investments by 2030 to around [USD 186 billion](#), focusing on operations in Europe. Some of the group's key brands are preparing next-generation ICE versions. Audi now considers its commitment to phase out ICE sales in Europe by 2033 to be flexible, planning to produce ICEs [beyond](#) the previously communicated date, while Porsche stated that its 80% EV sales target by 2030 is [no longer realistic](#) and will be adjusted according to market conditions. In September 2025, Porsche reported significant [expenses](#) in 2025 partially related to its EV strategy adjustment. Bentley stated that its target of exclusively battery electric cars by 2035 could now [include PHEVs](#), depending on customer demands.

Stellantis, the second-largest European OEM, which accounted for 5% of global car production in 2025, announced it would [abandon](#) its goal of becoming an all-electric brand in Europe by 2030 and is reviewing its long-term strategic plans following a [USD 27 billion](#) write-down, of which around three-quarters are due to its EV pullback, largely related to customer preferences and policy changes in the United States. For the North America market, the company is [cancelling](#) its PHEV programmes to focus more on hybrids and EREVs.

BMW is [sticking to its goal](#) to have EVs account for at least 50% of annual car sales by the end of the decade.

## China's automakers' ambitions rise, with focus on overseas expansion and impressive 2026 targets

In contrast to incumbent car industry players, in **China**, short-term EV sales ambitions for many Chinese OEMs have been bolstered alongside growing EV sales. As competition in the domestic market intensifies and the car market starts to become saturated, China's biggest carmaker, pure-play EV manufacturer BYD – now the world's biggest EV maker – is [aiming](#) to sell 1.3 million cars outside of China in 2026, which would represent an increase of nearly 25% from its 2025 overseas sales. In 2025, BYD's car sales [overtook](#) those of Ford, becoming the world's sixth-largest automaker group, accounting for over 5% of all cars produced globally in 2025. The company now aims for 50% of its sales to take place [overseas](#) by 2030, with planned factories to produce electric cars in Europe and Latin America and a plant already operating in Thailand. BYD also plans to expand its sales into the Japanese [kei car segment](#), which benefits from policy incentives and accounted for around 35% of Japan's car sales in 2025. BYD also saw success in markets such as [Australia](#) in 2025.

China's smaller pure-play EV OEMs also have ambitious growth plans for 2026. [Leapmotor](#) has set a target of 1 million electric car sales, representing growth of more than 65% compared to 2025 sales. [HIMA's](#) 2026 sales target stands at 1-1.3 million vehicles, up from less than 600 000 deliveries in 2025. [Xpeng](#) targets up to 600 000 deliveries in 2026, [Xiaomi](#) targets 550 000 deliveries (a 34% increase), while [Li Auto](#) targets about 40% growth for 2026 with a focus on EREVs, also translating to around 550 000 electric cars. [Nio](#) proposed an annual sales growth rate of 40% to 50%, expecting to deliver up to around 490 000 EVs. Combined, these smaller OEMs target around 4.5 million electric car sales for 2026 – a close to 65% increase from their 2025 sales.

OEMs that manufacture both EVs and ICE vehicles are also targeting growth. [Geely](#) now targets global EV sales of 2.2 million for 2026 – around one-third more than was reached in 2025. [Changan](#) targets 1.4 million EV sales for 2026 (a 40% increase compared to its target for 2025), while [Dongfeng](#) targets 1.7 million, and China's largest ICEV seller, [FAW](#), is aiming for EVs to account for 60% of its VW brands' sales by 2030.

## Automakers in the rest of Asia have varying perspectives depending on recent market and policy developments

A reduction of targets was also seen among OEMs headquartered in **Japan**. Honda acknowledged it will not meet its original 30% EV target for 2030, citing [market slowdown](#). Subaru increased its [R&D focus](#) on hybrids and ICEs, while Suzuki [reduced](#) the number of planned BEV models for Europe and India.

Hyundai, the world's third-largest and **Korea's** biggest automaker group, which produced 8% of new cars sold globally in 2025, has [introduced more flexibility](#) in its targets, aiming for 3.3 million electrified sales globally (including HEVs) by 2030, instead of 2 million BEVs. Kia [lowered](#) its battery electric car sales target for 2030 from 1.6 million to 1.26 million.

On the other hand, carmakers in **India** and **Southeast Asia** demonstrate more positive outlooks. After reducing its target in 2024, Tata is now expecting to meet its 30% EV sales share by 2030 goal [early](#). Given that Tata is one of the three largest OEMs in India's LDV segment, accounting for around 15% of annual sales, meeting the target could have strong implications for the country's pace of electrification. Citing strong momentum, Viet Nam's EV maker VinFast is [targeting](#) 300 000 car sales for 2026, equal to a 70% increase after impressive [2025](#) sales, particularly in Southeast Asia. As Chinese OEM sales in Southeast Asia continue to rise, Malaysia's largest carmakers [Perodua](#) and [Proton](#) have launched new battery electric car models in 2025.

## Automaker profits declined globally in 2025, but European OEMs recorded the biggest losses

Globally, automaker revenues declined 2% in 2025 after a 4-year-long period of growth, while total industry profits fell to approximately USD 46 billion in 2025, dropping below levels last seen in 2020, when global automotive markets were severely disrupted by the pandemic. However, in this instance, the drop in profits is attributable to accounting adjustments rather than a drop in sales volumes.

The transition from conventional to electric car production, combined with global trade tensions and weakening demand for foreign brands in China, weighed heavily on European OEM profitability in 2025. Year-on-year profits fell by around 140%, while revenues remained relatively stable. This large drop in net income can be largely attributed to accounting adjustments made by Stellantis and Renault. Excluding these one-off adjustments, [profitability is being squeezed](#) by high interest rates, rising raw material prices, and persistent cost pressures from suppliers. European car demand remained below pre-pandemic levels, and intensifying competition from Chinese manufacturers tightened margins on EVs. US automakers also experienced a drop in profitability, ending 2025 with a USD 2 billion loss, mostly due to EV-related accounting adjustments made by Ford and, to a lesser extent, GM. High vehicle prices and tariffs [pressured](#) the industry, but consumer preference for SUVs and pickup trucks helped sustain revenues.

**Figure 9.15 Global original equipment manufacturers' revenue and profits per region, 2016-2025**

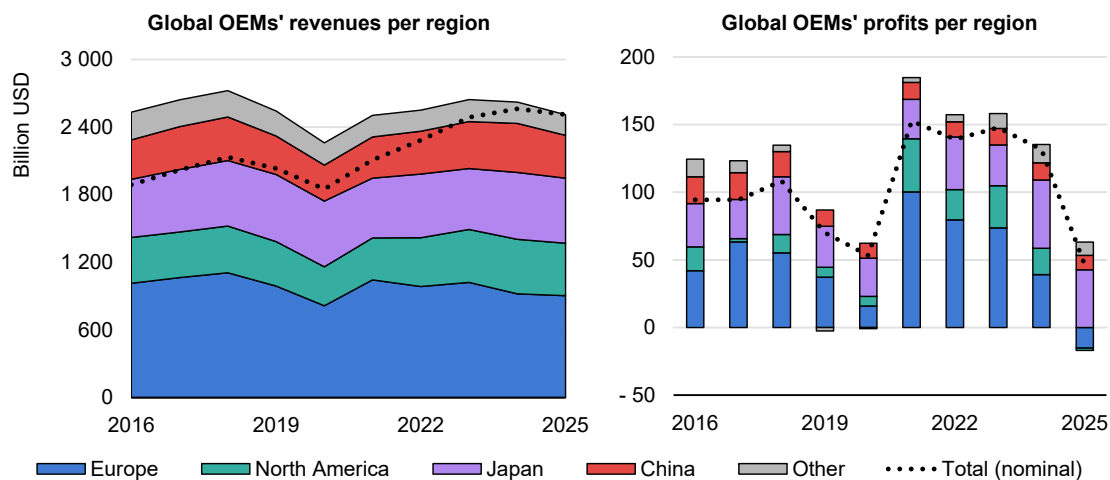

IEA. CC BY 4.0.

Notes: OEM = original equipment manufacturer.  
Source: IEA analysis based on data from Bloomberg Terminal.

Chinese OEM revenues fell by nearly 15% in 2025, following four consecutive years of growth. Although the sector remained profitable, posting around USD 13 billion in profits, overall profitability declined by almost 20% year-on-year. Rising sales volumes failed to translate into higher margins as intense domestic EV price competition – driven by OEMs seeking to expand market share – combined with elevated R&D spending, weighed on earnings. Japanese automakers also saw profits drop below their recent peak but still delivered USD 43 billion in total profits. Toyota maintained its position as the world’s largest carmaker, with production remaining similar to 2024 levels of around 9.5 million cars.

## EV battery demand outlook

### EV battery deployment more than triples by 2035

Global EV battery demand grows strongly as EV sales continue to expand, including in emerging markets. By 2030, EV battery deployment is expected to reach almost 3 TWh in both the CPS and STEPS, up from around 1.2 TWh in 2025. By 2035, deployment rises further, reaching around 4 TWh in the CPS and almost 5 TWh in the STEPS. To put this in perspective, on average, a single month of EV sales in 2035 would exceed the entire annual deployment of 2021.

Electric cars continue to drive EV battery demand, but the importance of other modes, and particularly of electric trucks, is expected to grow. In both the CPS

and STEPS, electric trucks are projected to account for around 10% of total EV battery deployment in 2030 and 2035, up from 8% in 2025.

The gap between current and stated policies and the NZE Scenario is significant, with EV battery deployment reaching around 9 TWh by 2035 in the NZE Scenario – almost double the level in the STEPS that same year.

**Figure 9.16 Electric vehicle battery deployment by mode, region and scenario, 2025, 2030 and 2035**

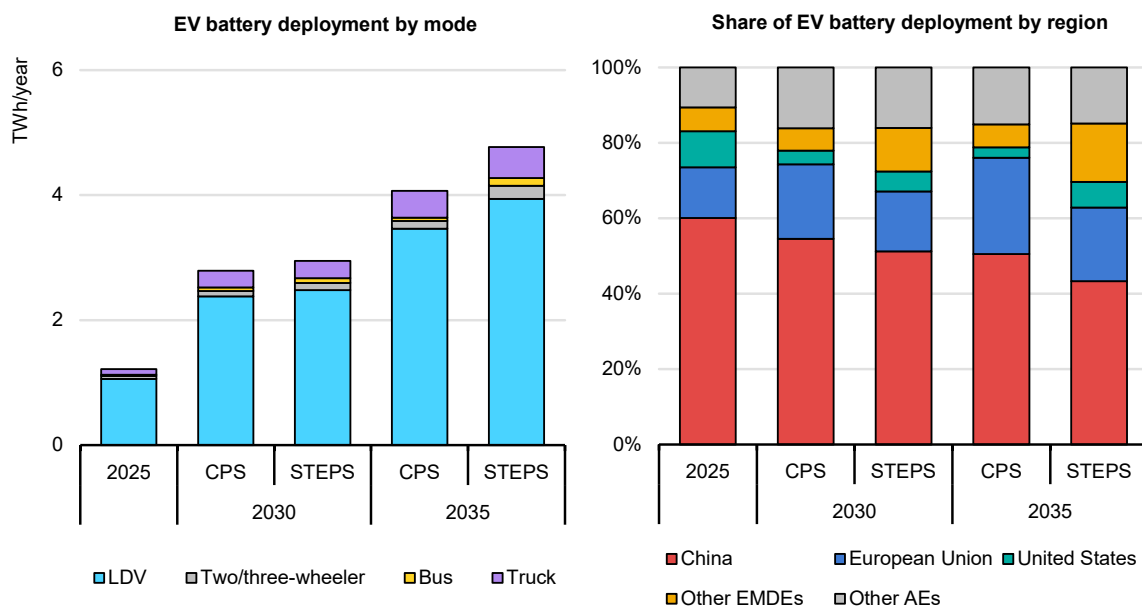

IEA. CC BY 4.0.

Notes: CPS = Current Policies Scenario; STEPS = Stated Policies Scenario; LDV = light-duty vehicle, including cars and vans; EMDEs = Emerging markets and developing economies; AEs = Advanced economies. Battery deployment is defined as the volume-weighted average battery size multiplied by vehicle sales by mode and region.

China, the European Union and the United States are expected to remain the main drivers of EV battery deployment, but their combined share is set to decline over the coming years as deployment in EMDEs grows. In the STEPS, the share of EMDEs in global EV battery deployment rises from around 6% in 2025 to about 15% by 2035, driven primarily by EV uptake in Southeast Asia, India and Latin America. In contrast, the United States sees the sharpest decline in share under the CPS, falling from around 10% in 2025 to less than 5% in both 2030 and 2035, reflecting slower growth relative to other markets.

Will more electric vehicles mean more mining?

The rapid deployment of electric vehicles (EVs) over the past decade has driven a substantial increase in demand for materials used in EV batteries and electric motors, such as lithium, nickel, cobalt and rare earths used in magnets (neodymium, praseodymium). Total demand for critical minerals grew by more than 30% between 2015 and 2024. Despite this, they represent only a small share of global extractive activities, which also include mining for construction materials, iron ore, bauxite, gold and fossil fuels. In 2024, around 8 billion tonnes of critical mineral ores were mined, of which around 320 million tonnes were related to EV batteries and motors. For reference, more than 100 billion tonnes of fossil fuels were extracted during the same year, mostly coal and oil. Within critical minerals, copper dominates mining volumes, accounting for roughly 85% of the total by mass, of which roughly 2% was used for EVs in 2024.

While growth in EVs increases critical mineral demand (as does growth in renewables), it also reduces fossil fuel use, leading to a net decline in total extraction over time. Between 2024 and 2035, combined fossil fuel and critical mineral extraction decline marginally in the Current Policies Scenario (CPS) and fall by more than 10% in the Stated Policies Scenario (STEPS), and by over 40% in the Net Zero Emissions by 2050 Scenario (NZE Scenario). Overall, the greater the deployment of technologies like EVs and renewables, the lower the extraction needs.

Importantly, critical minerals can be recovered through recycling – in the STEPS, battery recycling could meet 10-20% of lithium and nickel demand and over 30% of cobalt demand by 2050. This is in contrast to the vast majority of fossil-fuel-derived products, which cannot be recycled and are instead irreversibly consumed.

The switch to EVs can reduce both lifecycle emissions and long-term extraction volumes, but the local impacts of extractive activities must not be overlooked. If not responsibly managed, mining can damage local biodiversity, affect indigenous communities, and pollute land and water resources. Minimising these impacts is essential from both an ethical and a strategic standpoint – strong local support is critical to securing long-term, stable operations. Developing new mines requires many years to obtain permits and start production. Gaining and maintaining community trust is therefore central to the security and resilience of mining assets.

**RAW MATERIAL EXTRACTION BY SCENARIO IN BILLION TONNES**

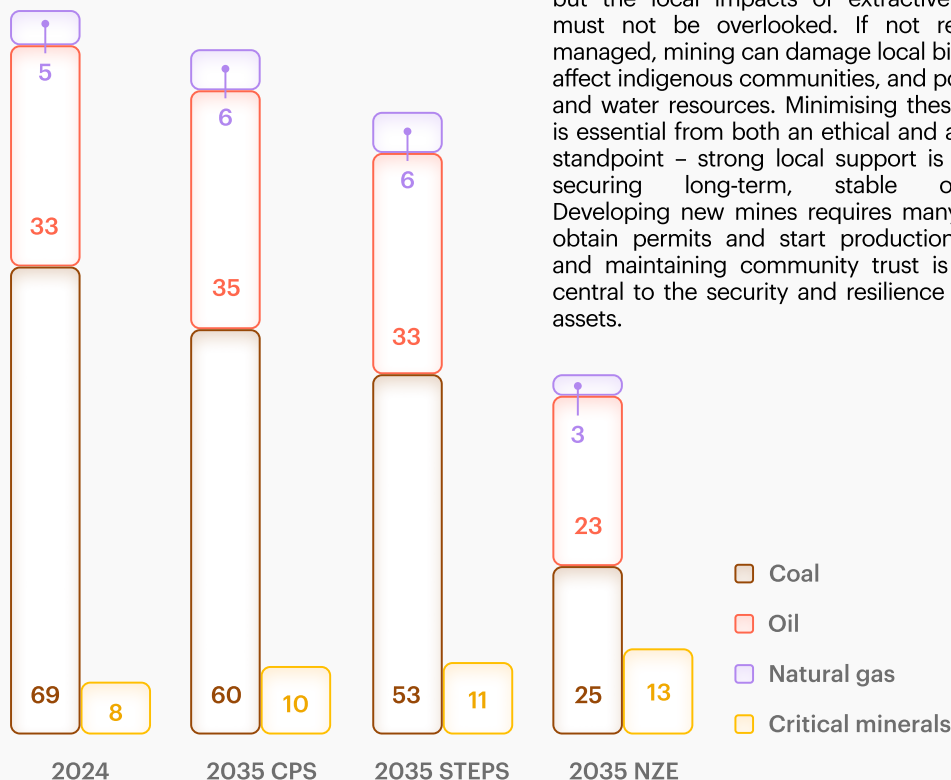

## Battery recycling

### Recycling will remain dominated by production scrap until end-of-life batteries take the lead in the mid-2030s

Battery [recycling](#) is crucial for the long-term sustainability of the battery industry and is likely to become an important future source of critical minerals, strengthening battery supply chain security and resilience. Today, recycling already plays an important role in supporting the battery value chain, primarily through the recovery of production scrap generated during the manufacturing of battery cells and components. However, beyond this, the contribution of recycling to meeting battery critical mineral needs still remains limited.

Deployment of EVs and battery storage systems – together representing around 90% of today's lithium-ion battery market – accelerated rapidly from 2020 onwards. Between 2020 and 2025, total lithium-ion battery deployment across all applications increased more than sixfold and it continues to climb. The associated surge in battery production has driven up demand for critical minerals such as lithium, nickel, cobalt and graphite.

The availability of end-of-life batteries for recycling has not increased at the same pace. Nearly all batteries deployed in EVs and stationary storage systems over the past few years remain in use today and most of them will operate until the mid-2030s, and [potentially longer](#). In practical terms, this creates a structural time lag – roughly 15 years – between the growth in EV battery demand and the moment when comparable volumes of these batteries start reaching end of life and become available for recycling.

**Figure 9.17 Electric vehicle battery and battery storage recycling feedstock by source in the Stated Policies Scenario and Current Policies Scenario, and maximum recycling output, 2025-2035**

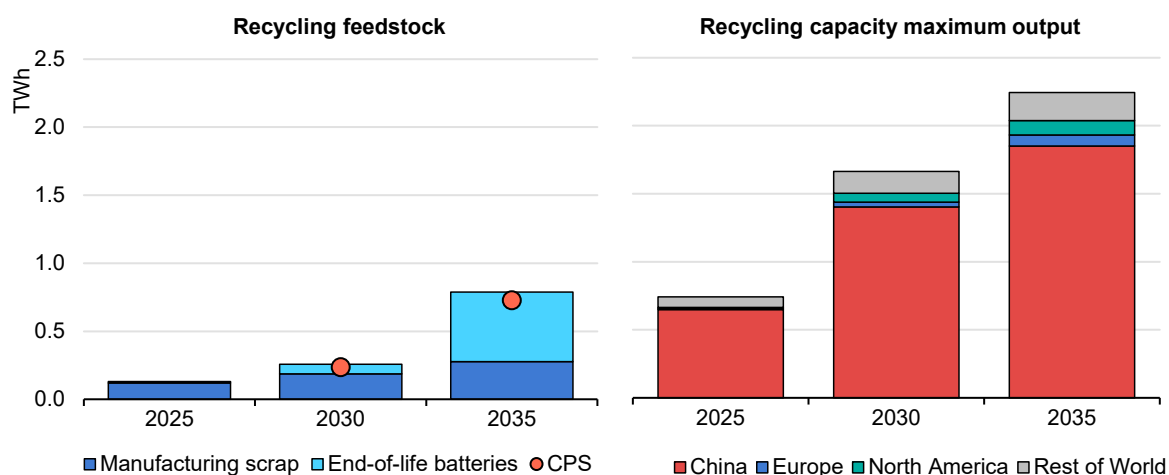

IEA. CC BY 4.0.

Notes: CPS = Current Policies Scenario. Left-hand bars show manufacturing scrap and end-of-life batteries in the Stated Policies Scenario. Manufacturing scraps and end-of-life batteries refer to electric vehicle and battery storage batteries. Other applications, such as portable electronics, are excluded from the analysis. Recycling capacity refers to material recovery. Maximum output assumes an average utilisation rate of 85% for all regions. See [Annex C](#) for more details.

Sources: IEA analysis based on data from IEA (2026), [Energy Technology Perspectives](#), IEA (2026) [World Energy Outlook](#), and [Circular Energy Storage](#).

China has a strong position in access to end-of-life batteries, reflecting its status as the world's largest battery producer and EV market, and it hosts over 85% of global recycling capacity.<sup>44</sup> Some recyclers – notably Brunp, the CATL-affiliated recycling subsidiary – benefit from direct links to major battery manufacturers, giving them preferential access to production scrap and ensuring steady feedstock volumes. However, others face [difficulties](#) in securing sufficient material feedstock, as recycling capacity is currently largely in excess compared to available feedstock globally.

Until recently, imports of black mass – a concentrated mixture of the metals originally contained in a lithium-ion battery – were banned in China. This changed in August 2025, when imports of high-grade black mass were [permitted](#). Import tariffs were also [reduced](#) at the start of 2026. While the short-term impact has been [limited](#), this policy shift could have significant medium-term implications. In particular, part of the black mass produced outside China may increasingly be sent to Chinese facilities for recycling, attracted by the country's available recycling

<sup>44</sup> Recycling capacity refers to material recovery.

capacity, expertise and lower processing costs. Nevertheless, this will also depend on [regulations](#) elsewhere, which could limit this flow.

At the same time, battery chemistry preference is shifting towards more affordable options, such as lithium iron phosphate (LFP) batteries, while interest in sodium-ion batteries is [growing](#). This poses challenges for recycling businesses relying on the economic value of the recovered critical minerals, potentially requiring different business models and devoted regulations to ensure that end-of-life batteries are properly collected and processed.

Toll-based models, in which the recycler is paid for the recycling service and the customer maintains ownership of the recycled materials, is an alternative approach. This model can be particularly effective when combined with policies that assign responsibility for end-of-life batteries to automakers or battery manufacturers, such as under the EU battery [regulation](#) or as recently [introduced](#) in China. Under such conditions, the main economic driver shifts away from the profit earned from selling recovered minerals – which may be insufficient for lower-value chemistries – and towards the savings associated with recycling compared with the cost of disposing of used batteries. This can reduce price volatility in recycling services and make recycling economically viable even when the recycling process itself is not profitable on a standalone basis, supporting the role of recycling in making the lithium-ion battery supply chain more resilient while reducing their environmental impact.

## Future flows of used EVs, batteries and recycling feedstock are uncertain and will shape the recycling market

Prices for used EV batteries have fallen sharply in recent years, mirroring declines in new lithium-ion battery prices and critical minerals. Historically, the price of used EV batteries has been particularly high, due to both inventories and the number of transactions being very limited. As flows of used and end-of-life EV batteries start to increase, prices are falling sharply, which over time will increase available material feedstock for recyclers, as well as opening up opportunities for battery reuse.

The used and end-of-life EV battery markets are still at an early stage, and future market dynamics are still to be defined. For example, in the second half of 2025 critical mineral prices began to rise again, while used EV battery prices in Europe and North America continued to fall. If this disconnection continues in the future, it might indicate that used EV batteries could be priced as a function of what downstream markets are willing to pay for reusing them, rather than as inventories of raw materials.

**Figure 9.18 Used EV battery prices and recoverable material values in North America and Europe, and global new battery prices, 2020-2025**

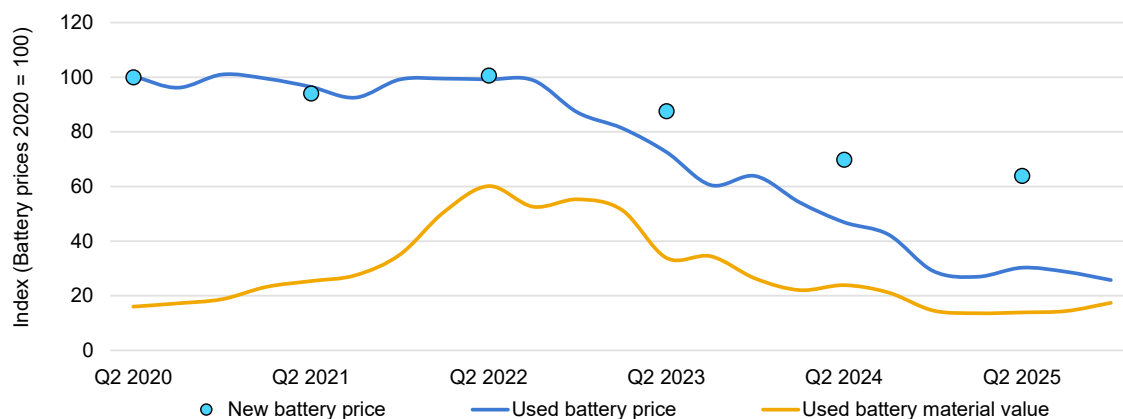

IEA. CC BY 4.0.

Notes: Battery refers to lithium-ion battery packs. Used battery prices and material values are indexed to the average used-battery price in 2020, while new average battery prices are indexed to the average 2020 new battery price.

Source: IEA analysis based on data from [Circular Energy Storage](#).

EV battery [reuse](#), for example for energy storage applications, remains [challenging](#). This is because of the safety and warranty requirements for second-life applications, uncertainty in remaining lifetime, falling prices for new batteries that reduce the economic attractiveness of repurposing, costs of dismantling and repurposing safely used EV battery packs, and the transfer of responsibility for safety, liability, regulatory compliance and end-of-life management to the [repurposer](#).

By contrast, the [second-hand EV market](#) is expanding rapidly, and reselling, repairing or refurbishing used vehicles currently generates [higher](#) profits than dismantling them for parts. As a result, the batteries inside these vehicles continue to operate for several more years, including in different markets and regions from those where the vehicles were originally sold.

This trend could have important implications for future battery recycling markets, particularly in higher-income regions such as Europe and North America. A share of the volumes initially expected to become available for recycling may materialise later than previously anticipated, and in different locations. Although recycling will strengthen the resilience of battery supply chains in these markets once sufficient batteries reach end-of-life, the growth of second-hand EV markets may reduce feedstock availability. This could require a recalibration of expectations regarding the contribution of recycling to domestic critical mineral supplies in the coming years.

Will there be enough critical minerals for growing EV adoption?

Electric vehicles (EVs) require more minerals than comparable internal combustion engine vehicles, largely because of their batteries, which use materials such as lithium, nickel, cobalt, manganese, phosphorus and graphite that are not traditionally used in the automotive industry. This has important implications for automotive supply chains, increasing reliance on a new set of critical minerals. That raises questions about the availability of these minerals and whether sufficient reserves exist to meet the needs of a rapidly expanding EV market.

Battery mineral reserves – comprising mineral resources that can be legally extracted in an economically viable way with current economic conditions and technologies – are more than sufficient to meet projected demand for the coming decades. This is the case even in the Net Zero Emissions by 2050 Scenario (NZE Scenario), which has the greatest critical minerals needs. Global lithium reserves stand at around 37 million tonnes, or roughly two-and-a-half times the cumulative projected demand in the NZE Scenario between 2026 and 2040, and far more than four times the projected demand in the Current Policies Scenario (CPS) and Stated Policies Scenario (STEPS) over the same period. For nickel and cobalt, reserves are one-and-a-half to two times projected 2026-40 demand in the NZE Scenario.

Moreover, critical mineral resources – the total mineral resource available, including reserves and deposits not yet economically viable to extract – are significantly larger than reserves for all battery minerals. Over time, additional resources and reserves are likely to be identified. For example, global lithium reserves grew by about 75% between 2020 and 2025. Recycling of end-of-life batteries will also supply a growing share of demand, reducing pressure on primary materials. Overall, the geological abundance of these minerals does not pose a fundamental constraint on the long-term development of the EV industry or other sectors that depend on them.

However, this does not mean that critical minerals are free of challenges. First, minerals must be extracted and processed at a pace that keeps up with demand, requiring sustained investment in the timely development of sufficient projects across the supply chain. For example, copper, a cornerstone of electrification, is expected to face significant supply tightness in the coming years, contributing to record-high prices. Second, the supply of many critical minerals is highly geographically concentrated, which increases exposure to supply security risks. In 2024, China was the leading refiner for 19 out of 20 strategic minerals, with an average market share of around 70%. Importantly, these minerals are essential not only for EVs but also for a wide range of energy-related and strategic applications, including defence.

**GLOBAL LITHIUM DEMAND BY SCENARIO (CUMULATIVE, 2026-2040) COMPARED TO GLOBAL RESERVES AND RESOURCES**

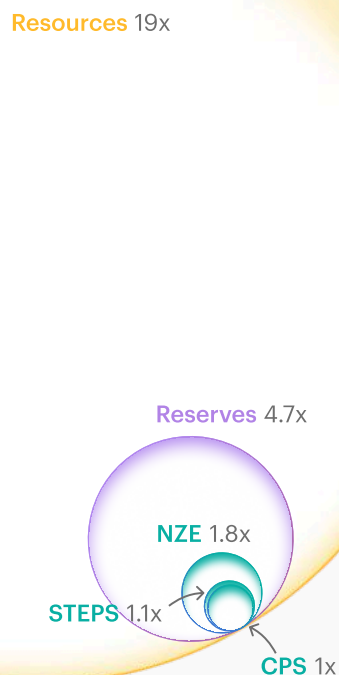

## Special focus: Manufacturing and trade outlook for electric cars and batteries

This section presents the outlook for manufacturing and trade on the basis of stated policies, using results from the IEA [Manufacturing and Trade \(MaT\) model](#) as presented in [Energy Technology Perspectives 2026](#).

### Global EV supply chains diversify but China remains the main production hub

The concentration of both demand for and production of EVs and batteries in China has created a tightly clustered supply chain, all the way from critical mineral refining and component production to battery and EV manufacturing. In 2025, China accounted for 70% of electric car production and over 80% of battery cell production, as well as about 85% of global production of cathode active material (CAM) and more than 90% of production of anode active material (AAM) used in electric car batteries.

Outside China, only Korea and Japan currently have sizeable CAM production, while Korea, Indonesia and Japan offer potential diversification options for non-Chinese AAM supply. Their combined capacity, however, remains insufficient to meet demand outside China (Figure 7.15). Outside of China, most battery cell manufacturing occurs in Europe and the United States – nearly all by companies headquartered in Asia (Figure 7.11). Electric car manufacturing is somewhat less concentrated due to the strong automotive industry presence in Europe, North America, Japan, Korea and other parts of the world.

In the STEPS, the electric car and battery supply chain diversifies, investment rises, and specialised workforces expand outside China as demand grows. This trend is incentivised by political support, such as production [tax credits](#) in the United States and the [Net-Zero Industry Act](#) in the European Union.

However, diversification remains limited, with China still the largest source of demand and production in 2035. By then, it supplies nearly 90% of AAM, about three-quarters of CAM and two-thirds of batteries. Most diversification is driven by advanced economies, accounting for almost 10% of AAM, 20% of CAM and about 25% of battery output in 2035, with the European Union and United States together providing almost 10% of CAM and 20% of battery production. EMDEs other than China produce nearly 5% of AAM and CAM by 2035, and increase their battery and electric car output share to about 6% and 10% respectively – about six and five times their 2025 shares. Electric car production also rises in advanced economies, reducing China's share to just below 60% in 2035.

Nevertheless, while EV production expands in advanced economies, the share of demand met by domestic manufacturing does not increase. Despite more stringent trade measures, such as EU countervailing duties on Chinese-made

battery electric cars, tariff reinstatements in Brazil and Mexico and new levies in Türkiye, Chinese exports continue to dominate global trade by 2035 in the STEPS. With unmatched capacity and low production costs across the EV supply chain, China’s exports are projected to grow, with over one in four electric cars sold in advanced economies made in China by 2035 (6 million) – up from 15% (just over 900 000) in 2025.

**Figure 9.19 Global manufacturing and inter-regional trade flows of electric cars, lithium-ion batteries and key components, 2025, and in the Stated Policies Scenario, 2035**

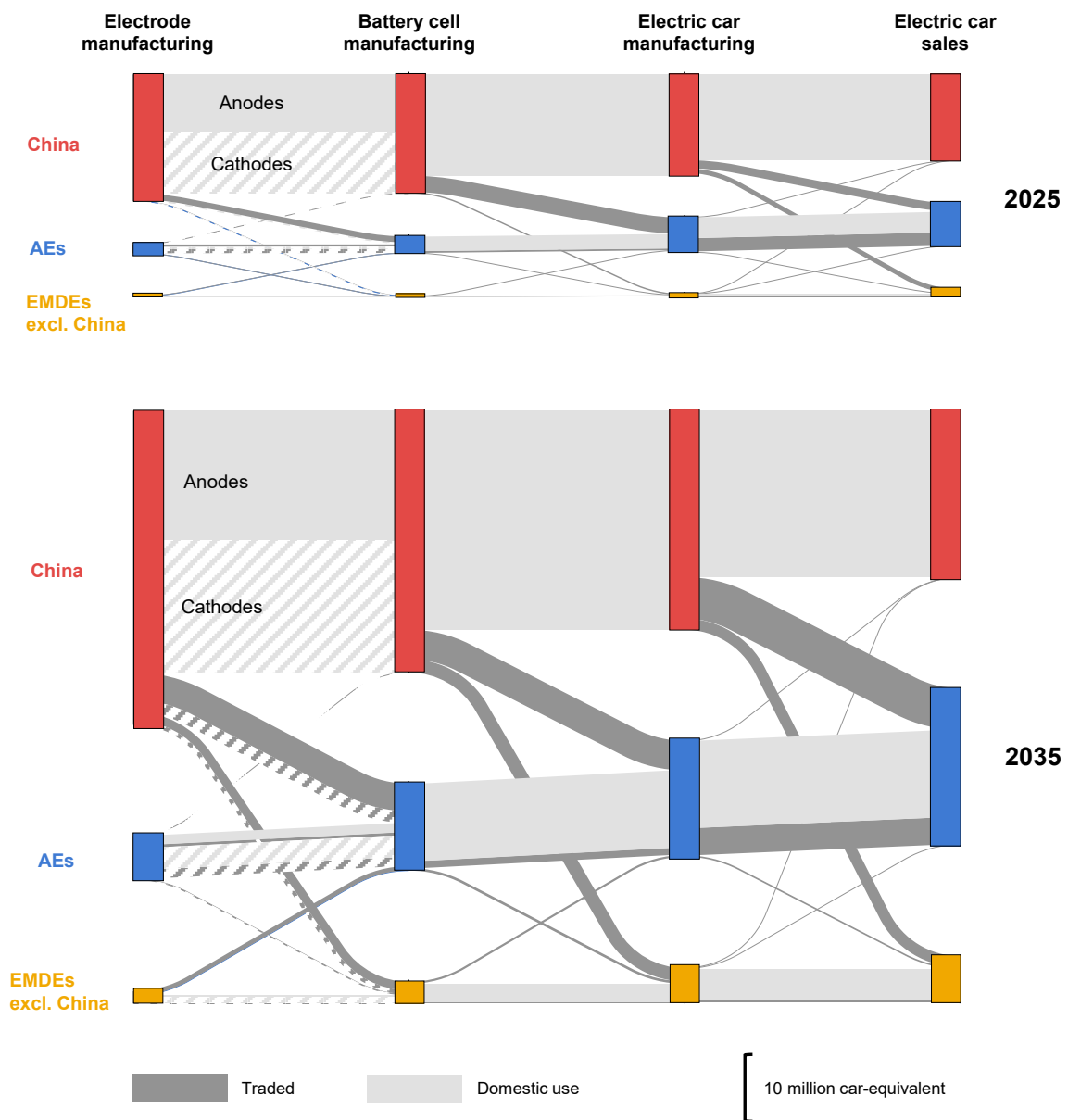

IEA. CC BY 4.0.

Notes: AE = advanced economies; EMDEs = emerging markets and developing economies. “Car-equivalent” is a combined unit of measure for electric cars, batteries and battery components, with the latter two expressed as the number of cars that could be produced with a given quantity thereof.

Sources: IEA analysis based on IEA (2026), [Energy Technology Perspectives](#); [EV Volumes](#); [Benchmark Mineral Intelligence](#); see IEA [Manufacturing and Trade model documentation](#) for details.

## Slower EV adoption in the United States dampens the outlook for import demand and battery plant utilisation

Several recent policy shifts have tempered the outlook for electric car demand and production in the United States. Although demand is projected to grow 20% by 2030 in the STEPS, this would represent just over 10% of total new car sales – down from the more than 50% that would previously have been needed to comply with the fuel economy standard.

These demand-side revisions have three main implications for the supply side:

- **Sufficient domestic capacity:** Despite several US carmakers [pivoting focus back](#) to ICE cars and delaying their EV strategies following recent policy shifts, US manufacturing capacity dedicated to electric cars is still expected to exceed 3.5 million units by 2030, complemented by a flexible ICE/electric car manufacturing capacity of nearly 8 million units. This project pipeline enables US plants to meet domestic demand through 2035 in the STEPS, without the need for additional investment.
- **Reduced need for imports:** A greater share of demand served by domestic production sharply cuts import dependency; remaining imports are costly due to a 25% tariff on all-electric cars. While US tariff and duty hikes increase import costs from all countries, they do so to a lesser extent for imports from Canada or Mexico that meet United States-Mexico-Canada Agreement (USMCA) trade agreement content [rules](#), giving North American producers a competitive edge over other importing regions. By 2035, imports are projected to reach 1.5 million units – almost entirely from Mexico – covering roughly one-third of domestic demand.
- **Weaker battery demand:** Lower EV sales also reduce domestic battery needs, weighing heavily on the US battery industry. Committed battery capacity by 2030 could produce nearly twice the projected US demand in 2035 in the STEPS.

By 2030 and 2035, battery production – supported by tax credits – is expected to be able to satisfy most domestic demand. The supply of cathode and anode active materials remains constrained by available manufacturing capacity, which would require additional [investments](#) that are now more difficult to justify because of lower projected battery demand in the United States. In the STEPS, US battery cell production reaches less than 350 GWh in 2030 and just over 400 GWh in 2035, primarily serving domestic needs, with the remainder exported to Mexico – equivalent to only about 40% of the nameplate capacity of currently committed projects.

This shift reflects weak domestic demand rather than insufficient production incentives. Recent [legislative updates](#) preserve tax credits for battery production while tightening long-term rules on prohibited foreign entities (PFEs), but also

introduce greater [short-term flexibility](#). As a result, investment continues to focus on the development of non-PFE supply chains for the US market. However, scaling these supply chains will require additional overseas production capacity, as domestic CAM and AAM committed capacity remains insufficient. Domestic production meets about half of CAM demand and about one-quarter of AAM demand by 2035 in the STEPS, leaving the United States reliant on imports. The shortfall is projected to be largely met by imports from Korea for CAM, while AAM supply is projected to depend on imports from China, Southeast Asia and Korea.

## Manufacturing and trade policies in the European Union increasingly support domestic manufacturing

Recent EU policy initiatives aim to bolster domestic EV and battery manufacturing through local content and market access requirements. The [Automotive Package](#) introduced CO<sub>2</sub> compliance credits for small affordable electric cars (M1E) that are made in the European Union, and proposed a zero-emissions vehicle (ZEV) mandate for corporate fleets. The presentation of the [Industrial Accelerator Act](#) (IAA) in March 2026 provided additional details on the criteria for “made in the European Union” status, although the proposal still needs to be debated by EU member states before becoming law.

To qualify for CO<sub>2</sub> compliance credits for small electric cars, and for corporate cars to be eligible for company tax incentives and public procurement schemes, final vehicle assembly must take place in the European Union and at least [70%](#) of the vehicle’s components (excluding the battery) in value terms must originate within the European Union. The IAA also introduces battery requirements, requiring that at least three main battery components, including cells, be of EU origin. For M1E vehicles, compliance can be achieved through either the vehicle component or the battery local content requirements, provided final assembly remains in the European Union.

Three years after the IAA enters into force, i.e. in 2030 if adoption occurs in 2027, the scope of battery requirements will be [extended](#) to at least five main components, including cells, CAM and the battery management system. This could require greater investments in manufacturing capacity and production of battery components, which today are largely dependent on Chinese imports (Figure 7.15).

Uncertainty remains regarding the definition of “[European Union origin](#)” in the local content requirements set out in the IAA. Components originating in third countries with which the European Union has concluded free trade agreements (FTA), or that are parties to the World Trade Organization Agreement on Government Procurement (GPA), could potentially be treated as meeting requirements, although this is not automatic and will depend on the final legal text. If broadly interpreted, this could extend eligibility to a large number of partner countries. Additional exemptions may further limit the impact of the IAA. Contracting

authorities may waive the requirements where only a single supplier can fulfil the contract, or where their application would increase costs by more than 25%.

If adopted in its most restrictive form, the IAA would send a strong signal in favour of greater localisation and supply diversification of electric car and battery manufacturing in the European Union. T&E estimated that around one-quarter of BEVs sold in the European Union by 2030 could fall under the 4.2-metre threshold required to qualify as M1E vehicles (similar to levels observed in 2025). In addition, given that corporate cars account for roughly 60% of new car registrations, a significant share of EU electric car and battery demand could become subject to IAA requirements.

**Figure 9.20 Electric car and battery sales shares by production location in the European Union in the Stated Policies Scenario, 2025-2035**

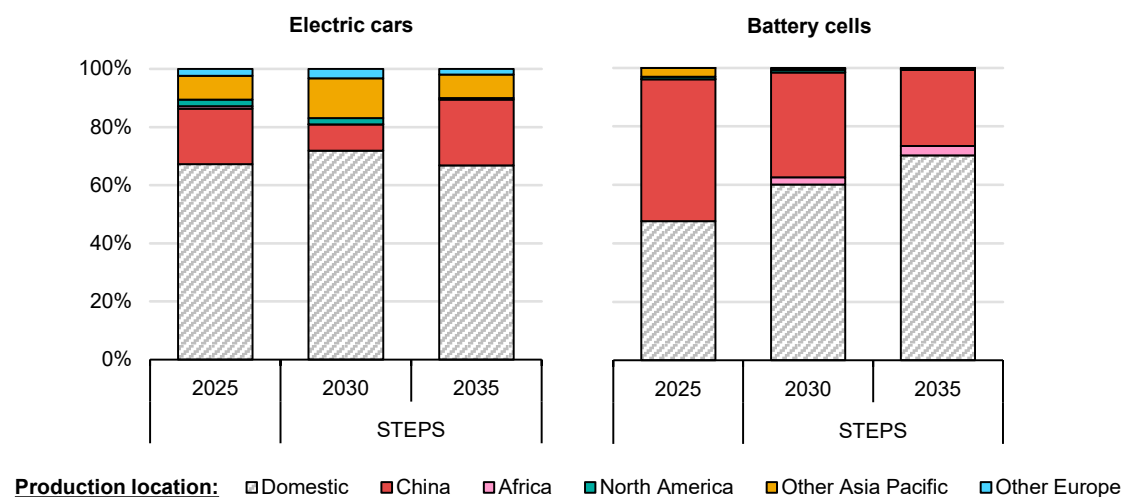

IEA. CC BY 4.0.

Notes: STEPS = Stated Policies Scenario. Domestic production refers to the share of production meant for domestic market and excludes exports. See the [Annex for regional groupings](#).

Sources: IEA analysis based on IEA (2026), [Energy Technology Perspectives](#); [EV Volumes](#); [Benchmark Mineral Intelligence](#); see IEA [Manufacturing and Trade model documentation](#) for details.

The IAA also proposes to subject to greater scrutiny future foreign direct investments higher than EUR 100 million (about USD 110 million) and made in emerging strategic sectors – including EVs and batteries – from countries holding more than 40% of the associated global manufacturing capacity. To qualify, such foreign direct investments should comply to at least four of the following conditions: local workforce requirements (greater or equal to 50% across all workforce categories), acquiring or owning a share of maximum 49%, investing through a joint venture with an EU entity and owning no more than 49% of the share capital, providing licensing of intellectual property rights and know-how, spending at least 1% of their gross revenue generated in the European Union in R&D within the European Union, or aiming to source over 30% of their inputs within the European Union.

For foreign investors affected by the new rules, compliance could be challenging, prompting some to frontload investment before the IAA enters into force. However, investment from leading manufacturers able to meet these criteria could be particularly valuable in sectors where the European Union has less production experience and a less mature industrial base – most notably batteries, where lower manufacturing efficiency compared with China accounts for [more than 40%](#) of the cell-production cost gap.

Current trade policies partly shield the EU automotive industry from lower-cost Chinese car imports. The [OEM-specific countervailing duties](#) (CVDs) implemented in July 2024, following an anti-subsidy investigation initiated in October 2023, have helped keep the share of Chinese imports in total EU electric car sales below the 20% mark in 2025. Current EU trade policy officially maintains CVDs on imports of Chinese battery electric cars until the end of 2029.

In January 2026, in an attempt to prevent any tariff escalation with China, the commission issued guidance on possible submissions from Chinese carmakers of [price undertaking](#) offers to avoid current CVDs. The framework introduces the possibility to set a minimum import price, at the vehicle model level, that cannot be lower than the final vehicle price otherwise paid with duties. [Volkswagen \(Anhui\)](#)'s joint venture was the first to file such an undertaking in February 2026, whereby it committed to minimum import prices, export quotas and local BEV manufacturing investments in the European Union.

The STEPS assumes the CVDs will continue beyond 2029, thereby constraining the market share of lower-priced Chinese models. In addition, EU manufacturing capacity is unlikely to limit supply, as many existing production lines can be quickly retooled to support EV production alongside conventional models: of 13 EV manufacturing projects [announced](#) in 2025, only 5 are greenfield investments, with the remainder involving conversions.

Based on current project pipelines, EU EV manufacturing capacity, including EV-dedicated and dual ICE-EV assembly plants, could reach 15 million units by 2030, far exceeding domestic demand, which stands at just 7 million in the STEPS. Under this scenario, the share of domestic demand met by imports remains around one-quarter through 2035 – with a growing number of cost-competitive imports from Korea, the rest of Europe and from Japan reducing China's share of EU imports to around 30% in 2030. From 2030 onward, limited manufacturing capacity among other exporters makes China's unused capacity increasingly relevant to meeting the European Union's growing demand. While imports from other regions remain unchanged in absolute terms, China's share rises again, capturing more than two-thirds of EU imports by 2035, or just over 20% of the electric car sales in the region.

## Rising local EV production in EMDEs and tightening trade policies challenge Chinese imports

Chinese exports to other EMDEs are set to rise, underpinned by competitive pricing, expanding shipping capacity and fast-growing demand in emerging markets. However, local production in EMDEs is well-poised to intensify competition with Chinese imports. Chinese OEMs, domestic brands such as Viet Nam’s VinFast, and India’s Tata and Mahindra, as well as incumbent automakers from overseas, are building or repurposing plants in EMDEs to serve local EV demand and export markets, benefiting from lower labour and energy costs. Southeast Asia is already home to more than half of China’s overseas dual ICE-EV manufacturing footprint, with capacity reaching almost 1 million units. Japanese and Korean incumbents in India and Southeast Asia, and European brands in South America, also own ample car manufacturing capacity and are retooling assembly lines. In India, for example, capacity could hit [1.8 million](#) by 2030, more than double the projected domestic demand in the STEPS.

In addition, while trade policy settings in the form of import duty waivers in Southeast Asia, India, Brazil and Mexico have fuelled growth in Chinese exports prior to 2025, recent policy updates are expected to curb this trend. [India’s](#) policy limits import duty exemption to 5 years, [Brazil](#) reinstated tariffs on electric cars in 2025, [Mexico](#) announced in 2025 it will raise tariffs on Chinese and other Asian EVs to 50% from January 2026, and most Southeast Asian countries’ significant tariff exemptions expired in December 2025, with industrial policy focus shifting towards increased localisation (see [Chapter 7](#)).

**Figure 9.21 Electric car sales shares by production location in emerging markets and developing economies excluding China, and in India, in the Stated Policies Scenario, 2025-2035**

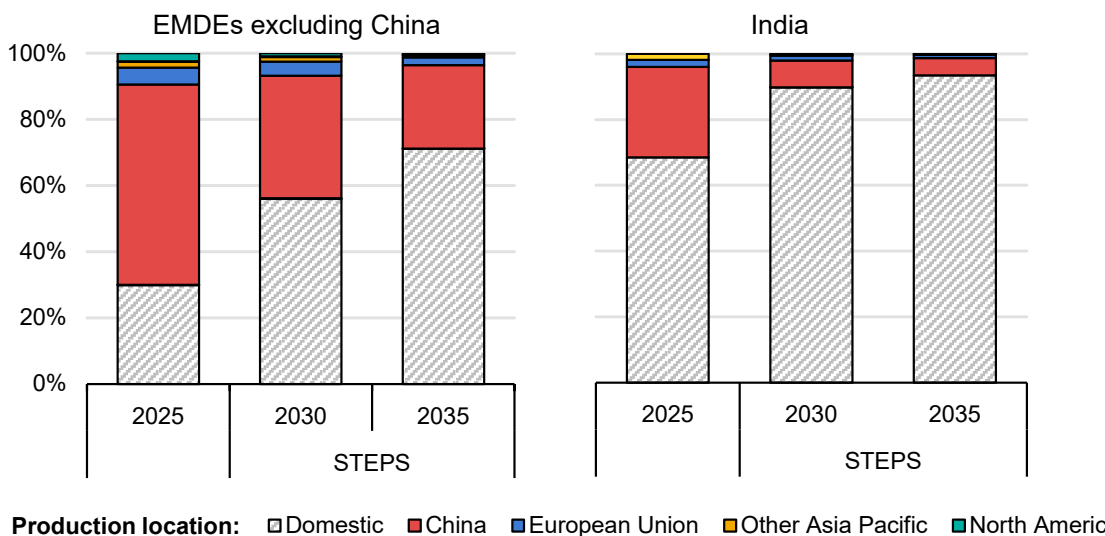

**Production location:** Domestic China European Union Other Asia Pacific North America  
 Notes: STEPS = Stated Policies Scenario. Domestic production refers to the share of production meant for the domestic market and excludes exports. See the [Annex for regional groupings](#).  
 Sources: IEA analysis based on IEA (2026), [Energy Technology Perspectives](#); [EV Volumes](#); [Benchmark Mineral Intelligence](#); see IEA [Manufacturing and Trade model documentation](#) for details.

In 2025, nearly two-thirds of electric car sales in EMDEs other than China were Chinese imports. By 2030, in the STEPS, although Chinese exports to other EMDEs grow more than 70% from 2025 levels, to exceed 1.2 million units, their share in these markets falls below 40%, as local output grows. By 2035, exports to EMDEs could reach around 1.6 million units – one-fifth of China’s total exports – but make up only 25% of total EMDE sales

## Global battery project pipeline largely meets 2030 demand

The committed battery project pipeline is sufficient to meet global deployment needs by 2030 across all regions, with substantial short-term overcapacity projected in China and the United States. Although building manufacturing capacity is only the first step – new facilities can take [more than 5 years](#) from the start of operations to near nominal output – the pipeline remains robust, indicating that producers are well positioned to supply the batteries needed for transport electrification and for stationary storage systems supporting power grids worldwide.

**Figure 9.22 Historical production and announced expansion of lithium-ion battery manufacturing maximum output by region, 2024-2025, and battery deployment needs by scenario, 2030**

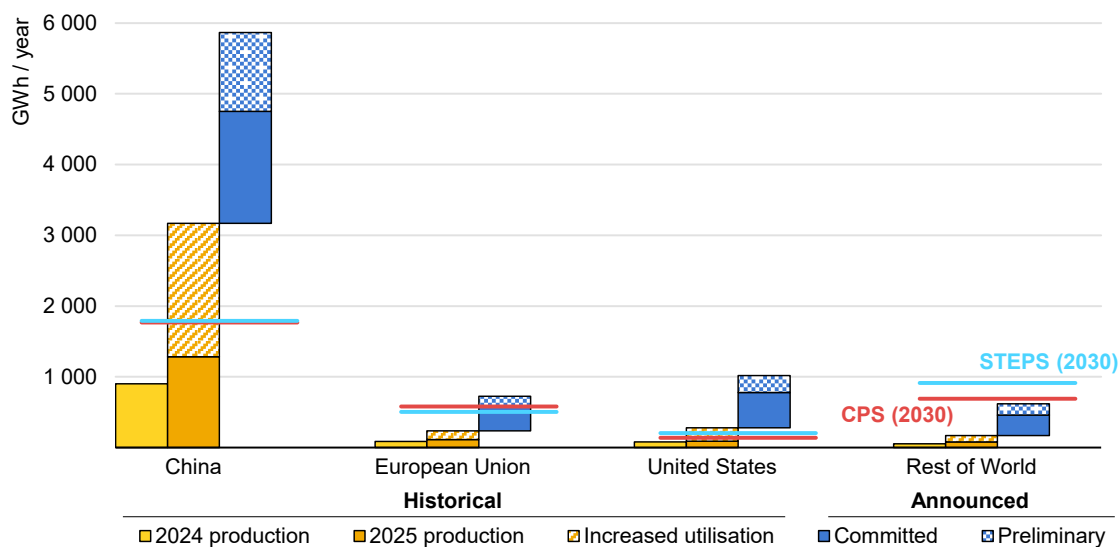

IEA. CC BY 4.0.

Notes: STEPS = Stated Policies Scenario; CPS = Current Policies Scenario. Increased utilisation refers to the gap between 2025 production levels and existing capacity being utilised at 85%, which is assumed to be the maximum average utilisation rate. A utilisation rate of 85% is also used for committed and preliminary manufacturing capacity. Production refers to the production of batteries that are deployed in a given year, while stockpiling is excluded. See Annex C for more details.

Sources: IEA analysis based on [EV Volumes](#), [Benchmark Mineral Intelligence](#), and [Bloomberg New Energy Finance](#).

Among all regions, Chinese, Korean and Japanese producers are expected to remain the dominant players in battery manufacturing through this decade, although Japan’s global share of installed battery manufacturing capacity is expected to decline based on current project announcements.

**Figure 9.23 Share of nameplate battery manufacturing capacity by region and location of battery producer’s headquarters, 2025 and 2030**

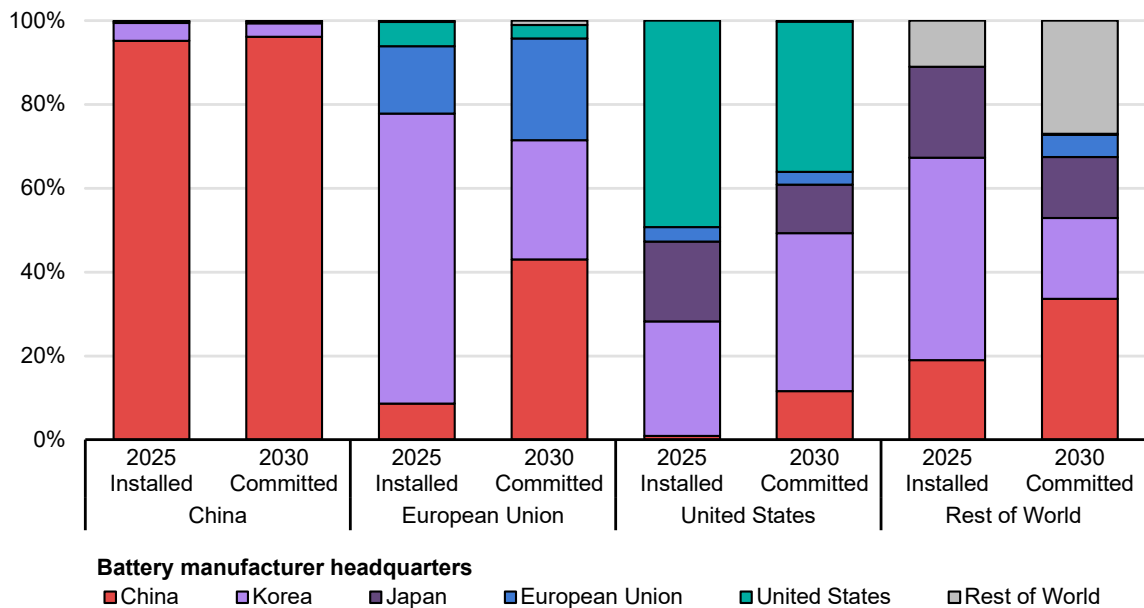

IEA. CC BY 4.0.

Notes: Committed refers to the sum of the installed manufacturing capacity (2025) and projects that have reached a final investment decision and are starting or have already started construction works. Manufacturing capacity refers to battery cells. For companies headquartered in a country but owned by companies headquartered in a second country, the headquarters of the owning company is considered for this analysis. The manufacturing capacity of joint ventures is shared as a function of ownership shares as of the end of March 2026. See [Annex C](#) for more details.

Sources: IEA analysis based on [Benchmark Mineral Intelligence](#) and [Bloomberg New Energy Finance](#).

# Chapter 10. Charging outlook

## Projecting charging needs

The charging point projections examined in this chapter are intended to reflect the level of deployment required to serve the stock of electric vehicles (EVs) projected in each scenario. As such, the charging projections are indirectly related to the policies and market trends driving the vehicle projections, as opposed to explicitly matching charging-related policies and regulations. Regional differences such as existing charging infrastructure, the share of fast chargers available today, and access to home or workplace charging have all been taken into consideration in order to design a realistic trajectory to reach sufficient public charging capacity.

Both the number of charging points per EV and the kW of available charging per EV (which accounts for faster chargers being able to supply more electricity) are important metrics used to determine whether a charging network is sufficient to meet the electricity demands of the EV stock. In the early stages of electrification, greater availability of public EV charging points can encourage adoption. As EV uptake increases, charging speeds improve, and battery ranges grow, the number of chargers needed per vehicle can fall as the system is gradually optimised. In addition to coverage, the capacity of public chargers can serve as an indication of sufficiency. Fast and ultra-fast public charging points can deliver more energy per day than slow chargers and thus serve a higher number of vehicles.

Projecting future charging stock by using historical and regional trends is particularly well suited for light-duty vehicles (LDVs), which make up a large share of the global EV stock. However, it is less appropriate for heavy-duty vehicles (HDVs), for which charging infrastructure is far less developed today and energy needs vary widely across regions. For HDVs, charging projections are derived from the projected electricity demand of trucks and buses. The necessary depot and public charging infrastructure is estimated based on the expected electricity demand of each vehicle segment.

## Light-duty vehicle charging

### To keep pace with EV adoption, public charging capacity for light-duty EVs grows sixfold to 2035

As EV adoption grows, public charging points are expected to increasingly provide more electricity, though home charging will continue to play a major role, given its affordability and convenience (see Figure 6.1). Charging availability at other

private locations, such as at workplaces, and public charging, plays an important role in supporting widespread adoption of EVs, especially among populations without access to home charging and for long-distance travel.

In the Current Policies Scenario (CPS), over 350 million charging points are added from 2026 to the end of 2035. Public charging points account for just 5% of the charger stock in 2035, as most additions are in fact home chargers (60%), or other private chargers such as charger points located at workplaces (35%). Despite the small share of public chargers, a third of the charging capacity in the CPS comes from fast and ultra-fast public chargers. Both private and public charging capacities grow rapidly. Private charging capacity will increase almost ninefold by 2035, and ultra-fast public charging increases more than fivefold as it becomes essential for long-distance use. As a result, in the CPS, as the number of electric LDVs per public charging point worldwide increases from about 11 in 2025 to 19 in 2035, the kW available per electric LDV will decrease from 4.5 kW/EV to 3.5 kW/EV, as utilisation of the network is expected to increase. With the deployment of more and faster public charging points, the average rated power of charging points does increase, from about 50 kW to nearly 65 kW.

**Figure 10.1 Global light-duty vehicle charger stock and capacity by type and scenario, 2025-2035**

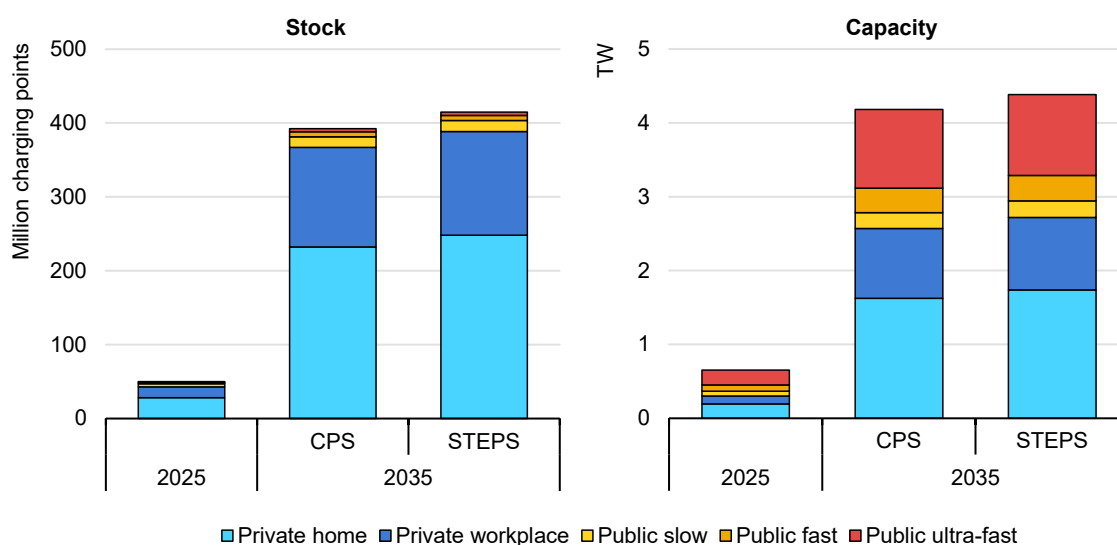

IEA. CC BY 4.0.

Notes: CPS = Current Policies Scenario; STEPS = Stated Policies Scenario. Home charging and workplace charging stock in 2025 is estimated based on electric light-duty vehicle stock and regional assumptions (see Figure 6.1). "Public slow" refers to charging points with a power rating of 22 kW and below, "Public fast" refers to power ratings between 22 kW and 150 kW, and "Public ultra-fast" refers to power ratings of 150 kW and above. Regional projected electric vehicle supply equipment stock data can be explored via the interactive [Global EV Data Explorer](#).

In the Stated Policies Scenario (STEPS), the stock of electric LDVs in 2035 is about 5% higher than in the CPS, leading to a corresponding 5% increase in both charger stock and capacity. The number of electric LDVs per public charging point reaches 19, the same level as in the CPS. In the Net Zero

Emissions by 2050 Scenario (NZE Scenario), the EV stock grows much more rapidly, around 60% higher than in the CPS, requiring the number of public charging points to increase nearly fivefold between 2025 and 2035.

The People's Republic of China (hereafter, "China") continues to dominate global public charging infrastructure. In 2025, the country accounted for the largest share worldwide, representing around 60% of the more than 4 million public slow chargers in operation. In the CPS, the global stock of public slow chargers rises to 14 million by 2035, with China remaining the main driver of global charger deployment. The worldwide electric LDV per public charging point ratio increases from around 18 to 33 in the CPS for slow chargers. Fast and ultra-fast chargers also expand rapidly. By 2035, in the CPS there are over 10 million fast and ultra-fast chargers worldwide, split into approximately 60% fast and 40% ultra-fast units. China's dominance is even stronger in this segment, with the country representing over 80% of the global public charger stock in 2025. Europe also accelerates deployment, reaching over 1 million fast and ultra-fast chargers by 2035 in the CPS.

**Figure 10.2 Number of public light-duty vehicle charging points by region and scenario, 2025-2035**

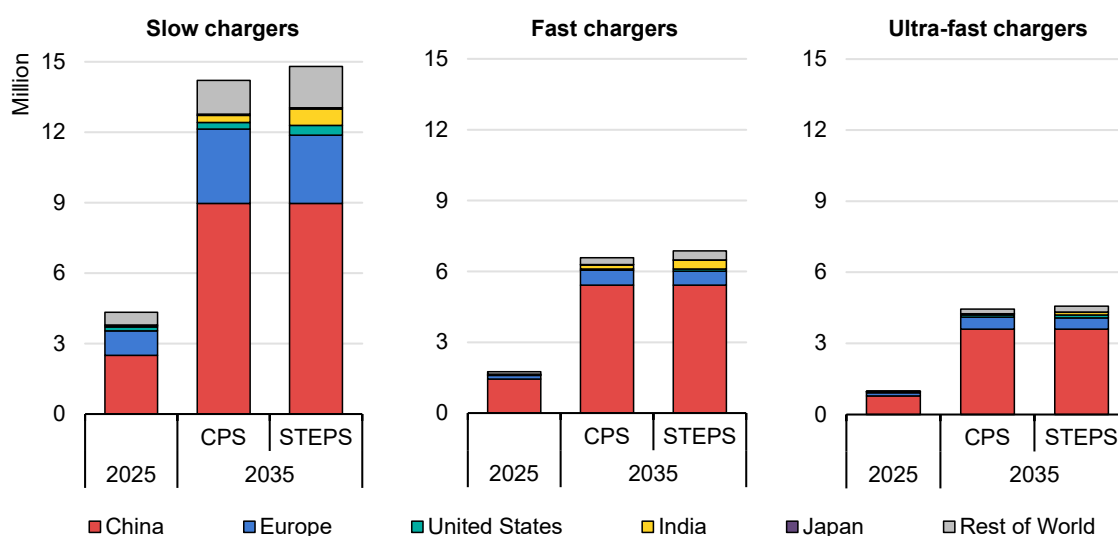

IEA. CC BY 4.0.

Notes: CPS = Current Policies Scenario; STEPS = Stated Policies Scenario. "Slow" refers to charging points with a power rating of 22 kW and below, "fast" refers to power ratings between 22 kW and 150 kW, and "ultra-fast" refers to power ratings of 150 kW and above. Regional charging point projections can be explored via the interactive [Global EV Data Explorer](#).

## Public charging in China to grow nearly fourfold by 2035 based on current policies

Over the past decade, there have been roughly ten or fewer electric LDVs on the road in China for every public charging point. This relatively low ratio is in part because Chinese EV owners have tended to be concentrated in dense cities with limited access to home charging. As the number of electric LDVs is identical in the

CPS and STEPS in China, the associated requirements for charging points and charging capacity are therefore the same. In the CPS and STEPS, the ratio of electric LDVs per public charging point remains relatively low but still increases to 15 in 2035. The stock of public charging points in China grows nearly fourfold by 2035, reaching nearly 18 million units. Ultra-fast charging infrastructure expands particularly quickly: The number of public ultra-fast chargers increases nearly fivefold by 2035, compared with a fourfold growth in slow and fast chargers over the same period. As a result, ultra-fast chargers account for nearly 20% of all public charging points in 2035.

In 2025, about 1.3 million public charging points were added in China. The average annual additions needed to reach the public charging stock required in 2035 is roughly the same, but still about 30% higher than the deployment level in 2024. In 2030, the average annual number of charging point additions required in both the CPS and STEPS is higher than in 2035, reaching around 1.6 million, as a result of the rapid EV stock growth expected in the coming years. Furthermore, the National Energy Administration’s [3-year action plan](#), presented in 2025, details a strategy to increase the number of public and private chargers from 20 million in 2025 to 28 million by 2027 (increasing by 4 million per year). Public charging points account for around 25% of China’s existing stock today. This implies that roughly 40% of the charging points added under the 3-year action plan would need to be public in order for deployment rates to match the average public-charger additions projected in the CPS and STEPS. By 2035, public charging capacity in China reaches approximately 1 300 GW, an increase of more than 1 000 GW compared with 2025.

**Figure 10.3 Public charging point stock, capacity and additions in China by scenario, 2025-2035**

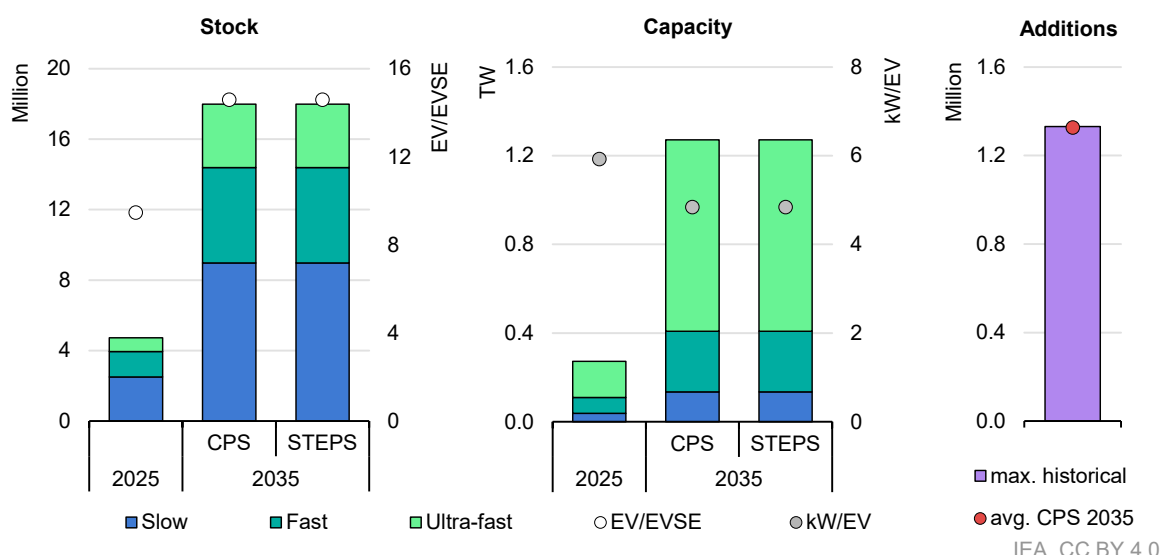

Notes: CPS = Current Policies Scenario; STEPS = Stated Policies Scenario; EV = electric vehicle; EVSE = electric vehicle supply equipment, avg. = average between 2026 and 2035, max. historical = maximum between 2020 and 2025. “Slow” refers to charging points with a power rating of 22 kW and below, “fast” refers to power ratings between 22 kW and 150 kW, and “ultra-fast” refers to power ratings of 150 kW and above. Average required charging points in CPS and STEPS are the same for China.

Sources: IEA analysis and country template submissions.

## In Europe, ultra-fast charging points increase to nearly half a million by 2035

In Europe, under the CPS, the stock of public charging points increases more than threefold to 2035, reaching over 4.3 million units. Slow charging infrastructure is expected to more than fourfold between 2025 and 2035, while the number of fast-charging points increases almost fivefold over the same period. Ultra-fast charging also becomes more widespread, reaching nearly half a million public charging points by 2035. The faster adoption of fast and ultra-fast chargers compared to slow chargers reflects the expanding share of fast chargers seen in Europe (see [Chapter 6](#)). As a result, total public charging capacity across Europe rises to nearly 200 GW in 2035.

As the number of electric LDVs in Europe grows nearly sevenfold in the CPS, the ratio of electric LDVs per charging point similarly increases from 15 in 2025 to more than 30 in 2035. With increasing installation of faster chargers, the charging capacity per EV only falls by 40%. In the European Union in 2035, this amounts to roughly 1.7 kW per battery electric LDV and about 0.9 kW per plug-in hybrid electric LDV in 2035. This level of public charging capacity exceeds the power output targets laid out in the [EU Alternative Fuels Infrastructure Regulation \(AFIR\)](#) (1.3 kW per battery electric LDV and 0.8 kW per plug-in hybrid). For the wider Europe region, 1. kW/BEV and 0.8 kW/PHEV is projected. Overall time-based utilisation of the European public charging network is also set to increase from 10% in 2025 to 15% by 2035.

To reach the level of public charging projected in the CPS in 2035, Europe must deploy an average of 300 000 public charging points per year until the end of 2035, which is above the current record of approximately 270 000 additions in 2024. In 2025, deployment decreased marginally to around 260 000 public charging points. In the CPS, the European Union's public charger stock reaches 2 million public charging points by 2030 and roughly 3.5 million by 2035.

In the STEPS, which includes the flexibilities announced by the European Commission, around 3.1 million public charging points are required to be deployed by 2035, around 10% less than in the CPS. Charging capacity is therefore also 10% lower, reflecting the lower EV stock in the STEPS compared to the CPS.

In addition to EU regulation, there are national targets for public charging infrastructure. These targets generally focus on deployment milestones for 2030, while explicit goals for 2035 have not yet been announced. For example, the French government aims to have [400 000](#) publicly accessible charging stations by 2030, about two times the number available at the end of 2025. The UK government has also stated an aim for at least [300 000](#) public charging stations in 2030, about two-and-a-half times the stock in 2025. The German government has set a target of [1 million](#) public charging points by 2030, though

energy industry [suggest](#) that this is more than will be needed. The German National Centre for Charging Infrastructure (NLL) [estimates](#) that between 380 000 and 680 000 public charging points will be required by 2030, depending on the availability of private charging options.

**Figure 10.4 Public charging point stock, capacity and additions in Europe by scenario, 2025-2035**

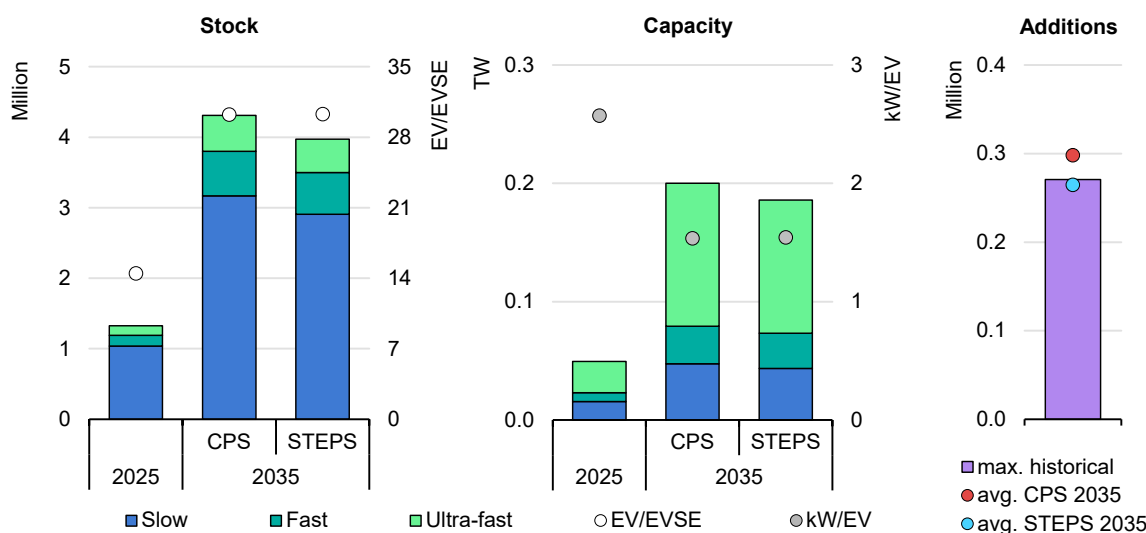

IEA. CC BY 4.0.

Notes: CPS = Current Policies Scenario; STEPS = Stated Policies Scenario; EV = electric vehicle; EVSE = electric vehicle supply equipment, avg. = average between 2026 and 2035, max. historical = maximum between 2020 and 2025. “Slow” refers to charging points with a power rating of 22 kW and below, “fast” refers to power ratings between 22 kW and 150 kW, and “ultra-fast” refers to power ratings of 150 kW and above.

Sources: IEA analysis and country template submissions.

## Public charging capacity in the United States to at least double by 2035

In the United States, the stock of public LDV charging points grows from around 235 000 in 2025 to more than 420 000 at the end of 2035 in the CPS. This assumes the historical trend in the increasing ratio of electric LDVs per public charging point continues, and that in 2035 there are more than 45 electric LDVs per public charging point, an increase of more than 10 electric LDVs compared with 2025. Although this ratio is more than double the global average, a large share of EV owners in the United States currently have access to home charging (see Figure 6.1). However, as EV adoption increases, the share of EV owners with access to private charging is expected to decline. As a result, public charging infrastructure will play an essential role in supporting future EV uptake.

The number of slow chargers is expected to nearly double between 2025 and 2035, while the stock of fast chargers is projected to almost triple. As a result, public charging capacity in the CPS rises from roughly 13 GW in 2025 to just under 30 GW in 2035. With higher utilisation of the public network, average available

capacity per EV slightly declines from 1.6 kW/EV to 1.5 kW/EV. Overall, the pace of charger additions in the CPS is around 50% lower than maximum annual seen in the last 5 years.

In the STEPS, the EV stock grows roughly fourfold over the decade, around 45% higher than in the CPS. Consequentially, by 2035, roughly 210 000 more public chargers are deployed in the STEPS, resulting in public charging capacity that is about 40% greater than in the CPS. To reach a total of 630 000 public chargers by 2035, the United States would need to install an average of 405 000 units per year, roughly equal to its historical peak deployment rate.

Under the 2021 US Bipartisan Infrastructure Law, the [National EV Infrastructure \(NEVI\) Formula Program](#) was created to provide funding to states to strategically deploy public EV chargers along highway corridors. The initial guidance focused on building charging stations at least every [50 miles](#) (80 km) along alternative fuel corridors. In August 2025, the Federal Highway Administration (FHWA) issued new, interim [NEVI guidance](#) giving states more flexibility for the charging infrastructure deployment, including removing the 50-mile spacing requirement. States also may now choose to use NEVI funding for medium- and heavy-duty chargers and upgrades to existing stations, once the state has concluded that alternative fuel corridors have sufficient LDV charging coverage. Many states have already had their final (fiscal year 2026) NEVI plans [approved](#).

**Figure 10.5 Public charging point stock, capacity and additions in the United States by scenario, 2025-2035**

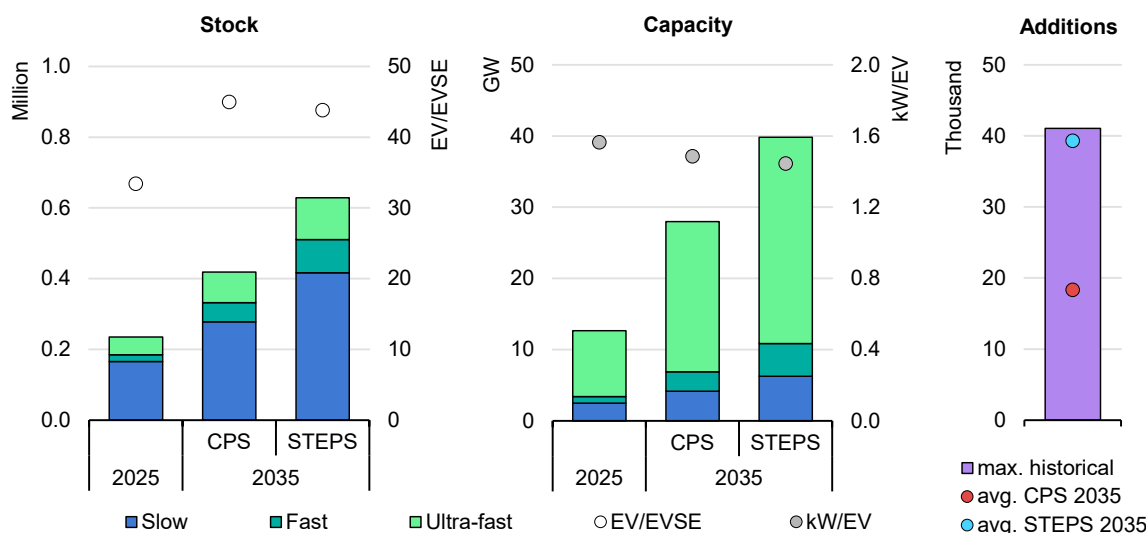

IEA. CC BY 4.0.

Notes: CPS = Current Policies Scenario; STEPS = Stated Policies Scenario; EV = electric vehicle; EVSE = electric vehicle supply equipment, avg. = average between 2026 and 2035, max. historical = maximum between 2020 and 2025. “Slow” refers to charging points with a power rating of 22 kW and below, “fast” refers to power ratings between 22 kW and 150 kW, and “ultra-fast” refers to power ratings of 150 kW and above.

Sources: IEA analysis and country template submissions.

## Public charging across the rest of the world will need to more than triple by 2035

EV adoption in regions other than the major markets profiled above is projected to increase in both the CPS and STEPS. In the CPS, adoption increases ninefold by 2035, at a more tempered rate than in the STEPS, which sees the electric LDV fleet grow to more than 85 million (45% higher than in the CPS).

In **India**, the number of public charging points increases from 88 000 at the end of 2025 to more than 520 000 by the end of 2035 in the CPS, to support a stock of about 3.6 million electric LDVs. As a result, in 2035 in the CPS there are around 7 electric LDVs per public charging point, up from 5 in 2025. To reach this projected stock of public charging points, around 43 000 charging points would need to be added on average each year until the end of 2035, about three-and-a-half-times more than the additions made in 2025. In the STEPS, India's fleet further electrifies with an additional 7 million electric LDVs by 2035, increasing the public charger stock to 1.2 million. The charging capacity is more than double in the STEPS than in the CPS.

In 2023, **Japan** announced a [target](#) of deploying 300 000 public chargers by 2030, including 30 000 public fast chargers. Achieving this target would require almost an eightfold increase compared with the public charging stock in 2025. In the CPS, Japan reaches a more moderate level of public charging infrastructure, with roughly 61 000 public chargers projected for 2030 and 72 000 by 2035. The EV-to-charger ratio is expected to rise from 20 in 2025 to about 60 by 2035. The high ratio of EVs to chargers today is due to the high share of PHEVs in the EV stock, and is expected to remain high. Compared with the CPS, the EV stock in the STEPS is 30% higher, resulting in a higher number of charging points and capacity. Capacity amounts to around 4 GW in 2035 in the STEPS.

In **Southeast Asia**, [Indonesia](#), [Thailand](#), [Malaysia](#), [Singapore](#) and the [Philippines](#) have dedicated roadmaps for public charging rollout. Indonesia has set the [target](#) of 32 000 public charging points by 2030, a sevenfold increase compared to 2025 levels. By 2030 in the CPS, Indonesia's projected stock of public charging points is 40% higher compared to this target, reaching 44 000 charging points, and increasing further by 2035 to 81 000. In the STEPS, higher EV adoption is projected, requiring the installation of an additional 37 000 chargers compared with the CPS in 2035. Indonesia also recently reduced minimum [foreign investment requirements](#) for charging station providers, reducing the barriers for entry and providing opportunities for joint ventures, co-financing, and risk-sharing with Indonesian co-operatives. Singapore, the Philippines, Thailand and Malaysia together account for about half of Southeast Asia's electric LDV stock today. Their

combined target<sup>45</sup> of 127 000 public charging points by 2035 corresponds to roughly 45% of the public chargers projected to be needed in Southeast Asia excluding Indonesia under the CPS, and about 40% of the projected needs under the STEPS.

## Heavy-duty vehicle charging

### Charging capacity for trucks and buses increases more than six times by 2035

Overnight private depot charging is generally the most attractive option for electric buses and trucks, given the lower power requirements and typically lower cost. However, to enable longer daily driving ranges and expand the applications that can be carried out by electric HDVs, en route or other opportunity chargers (such as at terminal bus stops or highway service stations) are needed. Public charging points for HDVs are also important for smaller fleet operators, as the investments needed for depot charging can be significant due to lower occupancy or high upfront costs.

In the CPS, the stock of HDV charging points increases from around an estimated 2 million in 2025 to more than 11 million in 2035. Depot charging continues to dominate charging, and still accounts for 99% of all HDV chargers in 2035. The stock of chargers for trucks grows more quickly than for buses. It is estimated that in 2025, truck chargers make up about 60% of all HDV chargers and this share increases to almost 80% by 2035. Charging capacity expands in line with stock growth, increasing nearly sixfold between 2025 and 2035. While depot charging provides the most capacity in 2035, public en route charging becomes increasingly important for long-distance trucks. By 2035, the number of public HDV chargers in the CPS is still low, at around 155 000 (1.5% of the stock), yet these chargers already provide around 7% of the total capacity. Compared with the CPS, in the STEPS around 13 million HDV chargers are deployed by 2035, resulting in a roughly 15% higher total installed charging capacity.

---

<sup>45</sup> Malaysia: 10 000, Philippines: 20 400, Thailand: 36 500, Singapore: 60 000.

**Figure 10.6 Global heavy-duty vehicle charger stock and capacity by type and scenario, 2025-2035**

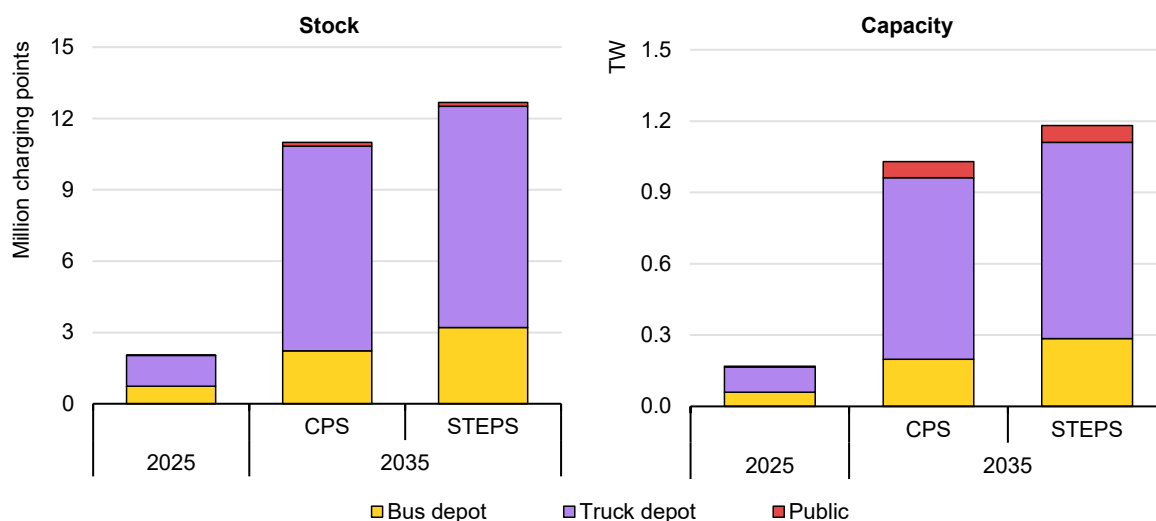

IEA. CC BY 4.0.

Notes: CPS = Current Policies Scenario; STEPS = Stated Policies Scenario. Charger stock in 2025 is estimated based on the number of electric buses and trucks.

By 2035 in the CPS and STEPS, **China** accounts for around 80% of the global HDV charger stock, with a total of about 9 million chargers, the majority of which are truck depot chargers. Public HDV chargers represent 1% of China's total stock in 2035, and those that do exist are primarily truck chargers.

**Europe** sees the number of depot chargers growing rapidly towards 2035, reaching around 1.3 million units in the CPS. Around a quarter of these are bus depot chargers. As in China, the number of public HDV chargers remains relatively low, reaching around 27 000 units by 2035 in the CPS. When considering EV deployment in the STEPS, just over 5% more depot and public chargers are deployed, due to slightly higher adoption of electric trucks and buses. Under the EU [AFIR](#), member states must progressively expand HDV-dedicated charging coverage along the TEN-T network. By 2030, the TEN-T network must be fully equipped with HDV charging stations, with maximum spacing of 100 km on the comprehensive network and 60 km on the core network. To meet these regulations, member countries are accelerating the rollout of dedicated HDV charging networks. Germany, for example, has launched national tenders for fast-charging infrastructure for electric trucks, and has committed [EUR 1.6 billion](#) (USD 1.7 billion) to support the deployment of 725 ultra-fast and 685 megawatt charging stations for HDVs in the coming years, to meet the AFIR targets. In parallel, regional and municipal authorities in several countries are also providing financial support to speed up HDV charging deployment (see [Chapter 6](#)).

In the **United States**, the HDV charger stock reaches only around 40 000 chargers by 2035 in the CPS. By contrast, in the STEPS, uptake of electric

trucks and buses is much higher, which would require the HDV charger stock to reach over half a million by 2035, of which most would be truck depot chargers.

Charger needs for HDVs in the rest of the world are low in the CPS, with only half a million charger points projected to be required by 2035. This is in contrast to the STEPS, where electric HDV uptake is much higher by 2035, resulting in a fourfold increase of the charging needs for this segment, to almost 1.5 million points. Many countries tend to electrify bus fleets prior to truck fleets, illustrated by the fact that bus depots account for roughly 70% of all depot chargers in the rest of the world.

**Figure 10.7 Number of heavy-duty vehicle charging points by region and scenario, 2035**

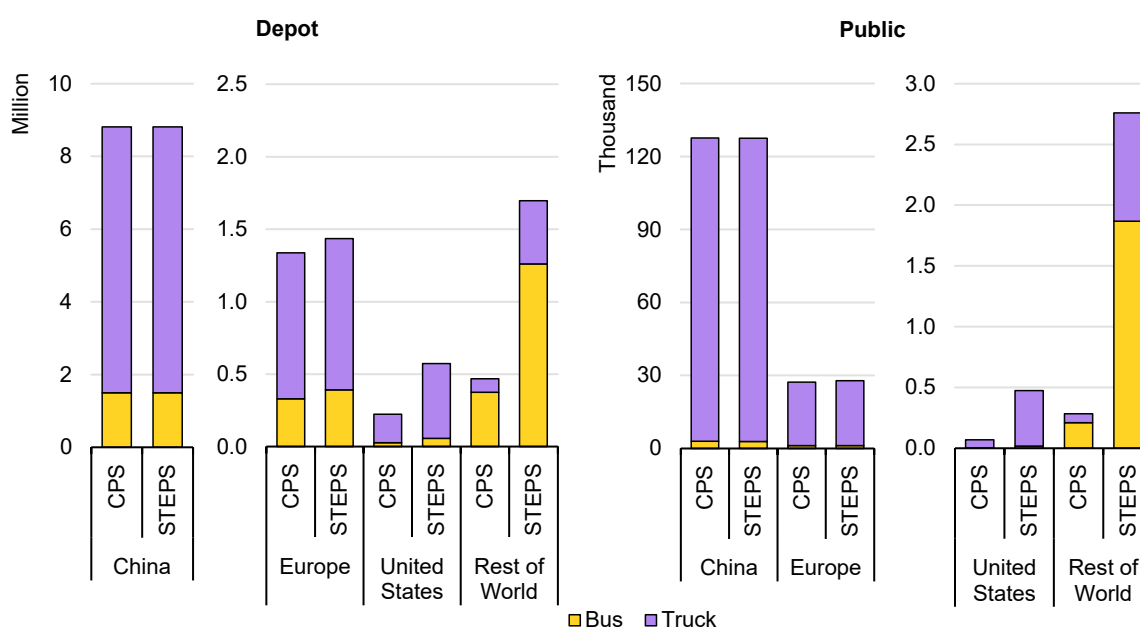

IEA. CC BY 4.0.

Note: CPS = Current Policies Scenario; STEPS = Stated Policies Scenario.

Despite the relatively low power rating for depot chargers (typically 50-150 kW compared to 350 kW to 1 MW+ for some opportunity charging) grid upgrades at depots may be needed, especially for larger fleets. This can take between one and several years, depending on the voltage, in particular (see the following section on grid investments). HDVs can also supplement dedicated HDV charging points by using public LDV charging stations that are accessible to larger vehicles. As the number of ultra-fast chargers for LDVs grows rapidly, the overall charging network will become more flexible and provide HDVs with many additional *en route* charging options. However, enabling true mixed use would require future LDV stations to be designed to accommodate both vehicle types (see [Chapter 6](#)).

Daytime charging of HDVs may also be suited to renewables, such as solar PV, which would support integration and ease grid demand. Co-locating charging hubs

with battery storage can further ease grid connection requirements, lower infrastructure costs and accelerate deployment, especially given today's record-low battery prices (see [Chapter 5](#)). Battery swapping offers another pathway to minimise grid constraints. This approach has gained strong momentum in China, where adoption is expanding. CATL, for example, plans to establish a nationwide swap network covering roughly [150 000 km](#) by 2030, serving about 80% of China's truck-line freight capacity (see the section on [alternative charging solutions in Chapter 6](#)).

## Charging investments

### Continued investment boosts net installations and the speed of charging infrastructure across regions

#### Higher power chargers come with higher capital costs

Both government and industry have played key roles in investing in and deploying the charging infrastructure available today. However, substantial additional investment will be needed to scale the network in line with growing EV adoption. The level of investment needed varies by region according to EV deployment by scenario, as do the capital and installation costs of EV supply equipment (EVSE), depending on charger speed, type and availability of materials, manufacturing scale and labour costs. Estimating the required investments needed in different EV-demand scenarios is intended to inform policy makers and investors to ensure that infrastructure growth aligns with anticipated demand.

The charging speed mix has a significant impact on estimated investment needs; higher power chargers come with higher capital costs. For example, the capital cost of fast chargers (22-150 kW) can be 14-75 times as expensive as the equipment cost for slow chargers, where slow charger costs currently range from around USD 100-650 (see [Annex E](#)). The equipment costs for ultra-fast charging that is below the megawatt scale (150-1 000 kW) are even higher, ranging from USD 23 000-USD 170 000 today. For HDV charging, megawatt-scale charging equipment costs even more: 3-7 times higher again compared to ultra-fast chargers, without considering installation costs or possible investments needed for grid upgrades. These can include service upgrades, transformer replacement, substation extensions and, for some sites, higher-voltage connections, all of which become more likely as station power increases (see grid section below). In general, EVSE equipment and installation costs in China are significantly lower than in Europe and the United States, though the cost gap also varies by charger speed.

### From 2026 to 2035, over USD 260 billion is projected to be invested globally in public charging infrastructure based on current policies

In 2025, almost USD 30 billion was invested worldwide in public charging infrastructure (specifically the equipment and installation costs). Although China represented three-quarters of the 2025 global public charging point additions, only two-thirds of investment took place in China, thanks to lower capital costs than in the other major markets. An estimated USD 11 billion was also invested globally in private charging infrastructure in 2025, with USD 9 billion specifically for residential chargers.

**Figure 10.8 Average annual electric vehicle supply equipment investments and public charging point additions by type and scenario, 2025-2035**

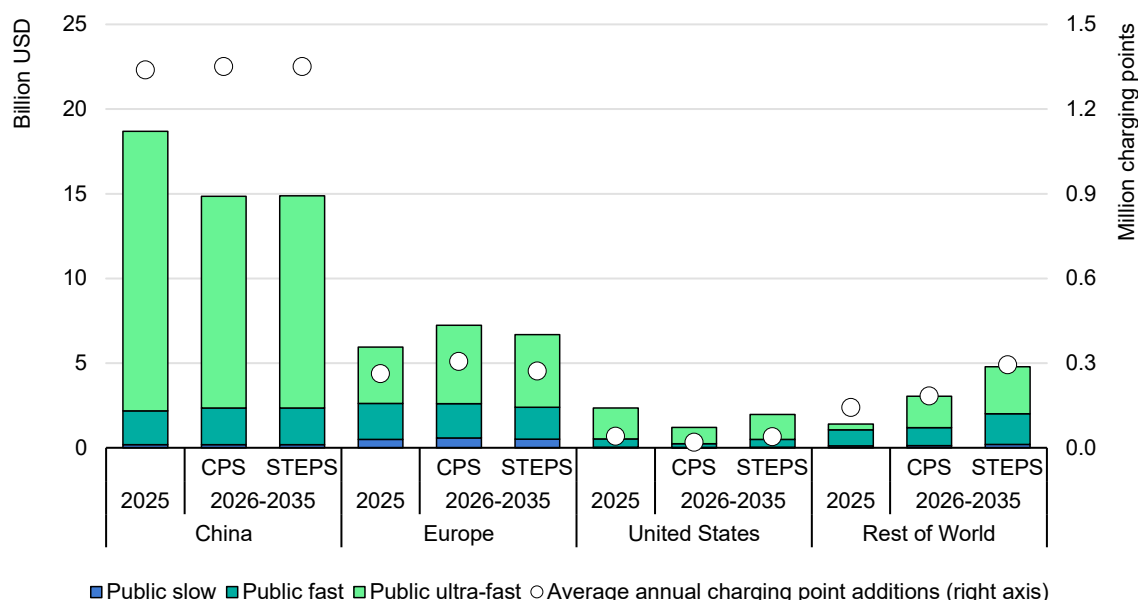

IEA. CC BY 4.0.

Notes: CPS = Current Policies Scenario; STEPS = Stated Policies Scenario. “Slow” refers to charging points with a power rating of 22 kW and below, “fast” refers to power ratings between 22 kW and 150 kW, and “ultra-fast” refers to power ratings of 150 kW and above. See [Annex E](#) for the EVSE cost assumptions.

In the CPS, cumulative (2026-35) investment in public charging infrastructure totals USD 260 billion globally. As such, the average annual investment needed in the CPS – USD 26 billion – is over 5% lower than the 2025 global investment in public charging infrastructure. In particular, the average annual investment needed in China (around USD 15 billion per year to 2035) for public charging infrastructure deployment in the CPS is almost 30% lower than 2025 investment levels, thanks to falling capital costs for EVSE. In Europe, an increase in the average annual charging point additions from 2026-35 in the CPS compared to 2025 leads to a 20% increase average annual investment in public charging. In the United States, the average annual investment in public chargers in the CPS

(2026-35) is only about half of the estimated investment in 2025. Outside of these three markets, average annual investments more than double from 2025 levels to 2035 in the CPS.

In the STEPS, cumulative EVSE investment needs from 2026 to 2035 are about 8% higher globally than in the CPS. In China, investments in public charging infrastructure are the same in both the STEPS and CPS. In Europe, because of higher EV deployment in the European Union in the CPS, STEPS investments in public charging infrastructure in Europe are on average about 10% lower from 2026-35 than in the CPS over the same timeframe. In United States, public charging investments in the STEPS are higher than in the CPS, but remain on average lower than 2025 investment. The most significant differences in CPS and STEPS charging investments occur outside of the three major EV markets, where cumulative investment in public charging infrastructure from 2026-35 exceeds USD 45 billion in the STEPS – 60% higher than that in the CPS.

## Additional grid investments will be required to support growing demand for EV charging

### Constraints on local electricity grids are emerging as EV uptake grows

Beyond charging equipment and installation costs, grid upgrades will increasingly be needed to supply additional EVSE. In the near-term, in some regions, at least, this can be mitigated by selecting station locations based on available capacity, but in the longer term the growing stock of EVs will necessitate network upgrades.

Grid capacity constraints, often described as grid congestion, have [emerged worldwide](#) as rising electrification [adds demand faster](#) than power grids can accommodate. In many major EV markets, local capacity-based grid restrictions often limit where EV charging stations can be installed, despite sufficient [aggregate power capacity](#) to meet the projected rise in electricity consumption from transport. EV charging, especially at high power, represents a significant new load on the low- and medium-voltage networks where most chargers [connect](#). If such loads have similar demand patterns and are clustered geographically, the resulting large increases in coincident load can place [considerable stress](#) on the surrounding grid as peak loads may approach or exceed line capacity limits. Further build-out of EVSE may be restricted or significantly delayed when optimal charging sites are located in places where capacity is not yet available.

The preparedness of electricity grids to absorb additional demand [varies](#) significantly across and within countries, which can affect the pace of charging infrastructure deployment. For example, in the [Netherlands](#), continued deployment of public chargers has produced one of Europe's densest charging

networks, yet distribution-level [congestion](#) in several regions is constraining new connections and slowing further rollout. In the [United Kingdom](#), strong EV uptake continues, but uneven public-charging expansion and local network constraints in several urban areas are delaying high-power connections and adding pressure to already-stressed distribution systems. In the [United States](#), some utilities are accelerating plans for distribution infrastructure reinforcement to accommodate growing charging needs, particularly in regions where peak load pressures are already limiting the integration of new chargers.

These trends are translating into growing grid connection queues, with connection requests increasingly subject to uncertain and often multi-year waiting periods before connection. Demand-side connection queues in the most constrained regions have become increasingly saturated by large new electricity loads from data centres, battery storage projects and industrial users. For comparison, it is estimated that globally, [one-fifth](#) of planned data centre build-out is at risk of delay due to grid congestion. Commercial vehicle operators, for example, could face waits of up to [15 years](#) for depot charging connections, a constraint that has already delayed electric bus or HDV deployment in the [Netherlands](#), [Ireland](#), and the [United Kingdom](#).

## Grid upgrades face high costs and long planning timelines

Planning and permitting for grid upgrades or expansions can be slow and highly sensitive to shifts in demand patterns, while uncertainty around charging profiles and electricity demand growth further complicates demand forecasting and investment decisions. Estimating investment needs is challenging, as location-specific cabling and connection requirements lead to large differences in the [scale of upgrades](#). Costs [increase](#) as project complexity grows and schedules lengthen, while [multi-year lead times](#) for key transmission-level components like transformers and high-voltage cables can extend timelines even when technical solutions are straightforward. Lower-cost options to expand grid power capacity are typically exhausted first, after which progressively higher-cost upgrades are required to meet electrification goals.

For charging stations that require a new distribution line to the nearest suitable substation, total project cost reflects the number of chargers installed, the site's maximum power rating, and the distance to the nearest substation. Charging equipment accounts for the largest share of project costs, while grid related costs rise as station size increases or as the required connection point lies farther away. Medium-sized mixed-use hubs make more efficient use of the infrastructure needed for both charging and connection, lowering the cost per unit of installed capacity compared with small rural sites or very large megawatt-scale hubs along highways.

**Figure 10.9 Typical investment needs for chargers placed far from existing grid lines in the European Union, 2025**

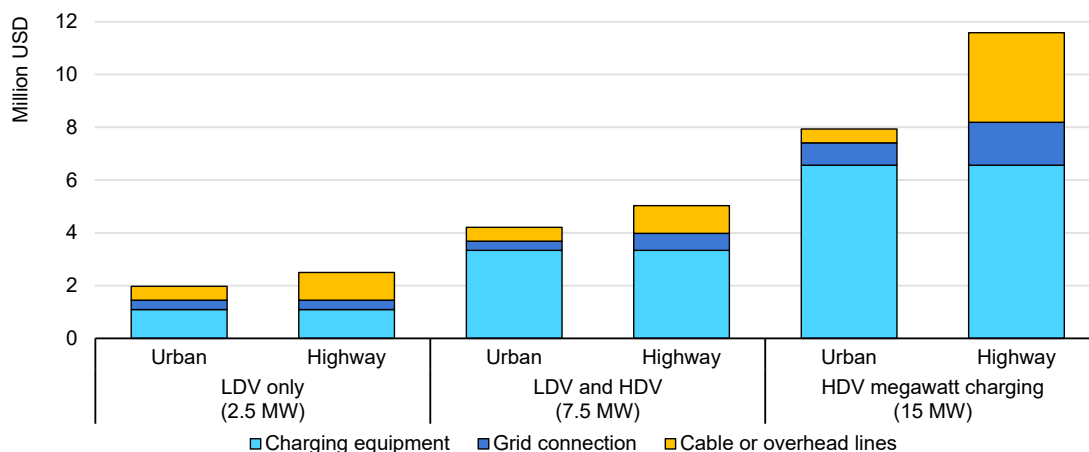

IEA. CC BY 4.0.

Notes: LDV = light-duty vehicle; HDV = heavy-duty vehicle. Assumed station power is given in brackets. Analysis assumes 5 km and 10 km distribution lines are built for urban and highway charging stations, respectively, and is most applicable to rural highways that lack adequate grid infrastructure or to urban areas experiencing grid congestion. The analysis assumes that existing substations have sufficient available capacity and does not model substation construction or reinforcement.

Sources: IEA analysis based on [University of Wuppertal \(2016\)](#), [Netbeheer Nederland \(2019\)](#), [Bundesnetzagentur, Etalab, Plötz, P., Speth, D., Kappler, L., Klausmann, F., Satvat, B. \(2024\)](#), [TotalEnergies \(2024\)](#), [ACEA](#), [BEEV](#), [CEER](#), [Tsiropoulos, Siskos & Capros \(2022\)](#).

Grid-related costs in the projects that have been analysed are determined by two major factors: the connection voltage required at the substation and the distance the new line must cover. Higher-power stations may need to connect at higher-voltage levels, which raises equipment and installation costs. In the European Union, stepping up from 30 kV to 110 kV can add more than EUR 3 million (USD 3.2 million) to total project cost when a new line to a suitable substation is built. Line cost increases with distance, since more cable or overhead line must be installed to reach a suitable substation.

Rural charging sites tend to have a higher connection cost than those located close to existing demand centres, as electric infrastructure in rural areas tends to be [less robust](#) or resilient. Rural sites, specifically along highways, often require longer line construction and may need higher-voltage connections to mitigate electricity losses across longer routes. Isolated, megawatt-scale hubs along highways are therefore the costliest type of charging station to connect, as high voltage requirements require expensive cables over long distances. Small LDV-only sites are also sensitive to distance-driven costs, as limited charging capacity means a larger share of total investment goes towards the line needed to reach the substation.

Alternative solutions, such as on-site battery energy storage or renewable generation, can be leveraged to ease grid capacity requirements and advance highway electrification. Such solutions come with [additional capital costs](#) and site-

specific requirements to be evaluated during site development. In addition, demand-side measures such as [smart charging \(V1G\) or vehicle-to-grid \(V2G\)](#) can reduce peak power demand by shifting or modulating charging loads, helping to improve utilisation of existing grid assets and delay the need for network reinforcement where flexibility is available.

## Policy efforts can help reduce delays and anticipate growing power demand for EVs

There is a strong argument for locating new charging stations in areas with existing grid capacity, since grid connection requirements can quickly increase station cost. Policy makers can support more efficient siting by encouraging system operators to publish hosting-capacity maps, which indicate where the local grid can accommodate additional load without significant upgrades. Clear visibility of available capacity, even when data quality is limited, [reduces the number of load survey requests](#) that utilities must process and helps developers focus on locations where new charging hubs can connect with fewer difficulties.

Where capacity constraints cannot be avoided through careful siting, demand-side flexibility measures can be used to [reduce the grid capacity required to connect charging infrastructure](#). Policy frameworks that support the implementation of flexible demand can influence how grid capacity is planned and used alongside grid expansion. By lowering power use during hours of peak load, flexible demand for charging can improve utilisation of existing network assets and reduce the grid capacity required to connect new projects.

Many new charging hubs will still be needed in areas without sufficient grid capacity, and proactive grid development can improve the cost-efficiency of this build-out while also meeting growing electricity demand from other sectors. Proactive grid build-out is particularly important for the electrification of heavy-duty transport, where high-power charging requirements magnify the consequences of insufficient grid capacity or a lack of developed infrastructure. Anticipatory investment can also shield consumers from extended delivery timelines, since building ahead of need reduces the risk that long procurement cycles delay connections when demand materialises.

The combined benefits of lower costs, shorter timelines, and improved system resilience make anticipatory development a no-regret option when regulators provide clear planning guidelines, reliable cost-recovery mechanisms, and predictable investment signals. Regulators can also help shorten the time spent in interconnection queues by improving process transparency, data-sharing, and collaboration across stakeholders, which helps ensure that charging infrastructure can be delivered on time, in the most valuable locations.

The United Kingdom has acted on these principles through the [Accelerated Strategic Transmission Investment](#) framework, which provides a regulatory fast-track for qualifying transmission projects to advance renewable integration. Similarly, the European Commission's [European Grids Package](#) contains a proposal aimed at reducing delays in energy projects caused by permitting, and proposes [guidance](#) encouraging EU member states to reform grid connection queues by prioritising projects based on readiness rather than a simple first-in, first-out approach. India has also implemented [measures to reduce connection queues](#) and drive EV adoption through the introduction of maximum timelines for distribution-level EVSE projects to receive an energised grid connection.

### **Box 10.1 Policy support and economics of charging infrastructure**

The shift to electric mobility depends on charging operators being able to deploy and operate assets on a profitable basis. From an investor perspective, this means generating an internal rate of return (IRR) that exceeds the cost of capital. The IRR represents the discount rate at which the net present value of a project's cash flows equals zero. It is a widely used metric for assessing project returns and guiding capital allocation.

Most charging infrastructure investments take several years to reach profitability. Operators in both the United States and Europe point to the same constraints: slow utilisation ramp-up, delays in permitting and grid connection, and high grid connection costs. Together, these factors mean that capital expenditure (CAPEX) is concentrated upfront while revenues accumulate only gradually in the early years of operation.

This reflects a structural co-ordination challenge in the development of EV charging infrastructure. A widespread charging network is needed to support EV adoption and reduce range anxiety, but utilisation may remain low until the EV fleet reaches sufficient scale. To sustain infrastructure rollout, public authorities have introduced a range of measures, including capital expenditure grants (e.g. [California's Fast Charge California Program](#), financing up to USD 55 000-USD 100 000 per fast-charging port, depending on power rating), accelerated permitting procedures (e.g. [Colorado's HB 1173](#), requiring EV charger permits to be approved or denied within 30-60 days, with automatic approval if agencies fail to act) and partial public financing of grid connection costs (e.g. [New York's EV Make-Ready Program](#), covering up to 100% of the electrical infrastructure costs for installing EV charging stations). Although these measures share the dual goal of crowding in private investment and limiting fiscal exposure, they place different demands on public budgets and affect project returns unevenly.

It can be useful to evaluate public support measures through the lens of private project finance. A project-level cash flow model can be used to assess how specific policy levers affect long-term bankability (see Figure below). The model is built on simplified archetypes using Germany as a case study. It considers an urban case, where the charging station is in proximity (approximately 1 km) of medium-voltage transmission lines, and a highway case, where the charging station is located at a longer distance from transmission lines (approximately 10 km).

This finds that capital expenditure grants improve early-stage liquidity, but shortening the time needed to break ground has the largest impact on project IRR, raising returns by about 5-6 percentage points in both highway and urban cases, compared with roughly 3 percentage points from CAPEX grants. Earlier connection brings revenues forward and reduces the impact of discounting. Similar conclusions were reached by a [study conducted by Atlas Public Policy](#), which finds that reducing delays by 6 months raises net present value (NPV) by about USD 104 000 for a 600 kW fast-charging station and USD 165 500 for a 1 MW station.

#### Internal rate of return under different policy support measures in a highway and urban setting for ultra-fast chargers, 2025

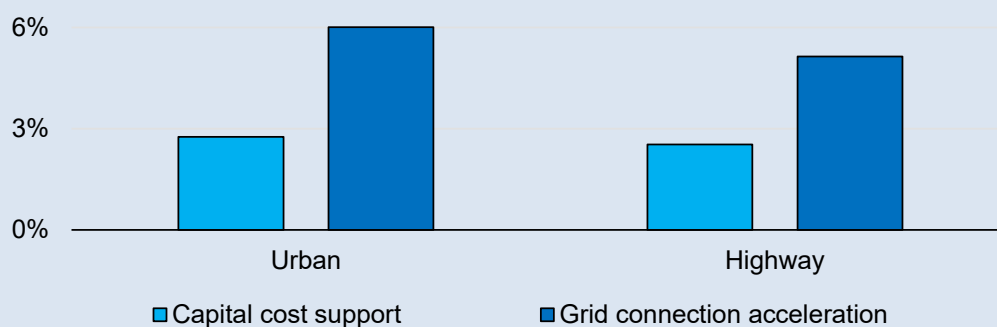

IEA. CC BY 4.0.

Notes: Retail charging prices are assumed to be [EUR 0.80/kWh](#) and wholesale electricity prices are estimated at approximately EUR 0.20-30/kWh, including variable grid fee and demand charges. See [Annex E](#) for more detail on the methodology.

These findings have implications for policy makers. CAPEX grants can become fiscally burdensome when scaled across large networks, particularly where grid connection and reinforcement represent a large share of project costs. Meanwhile, policies that shorten permitting and grid connection timelines can improve project economics without requiring large direct subsidies. The cost of such measures is harder to quantify, as it often takes the form of administrative reform, faster permitting, or better co-ordination between network operators and project developers rather than direct fiscal transfers.

## Electrification along road networks should be part of grid planning in emerging economies

Rapid growth in electricity demand often faces constraints in emerging economies where grids are ageing, incomplete, or still expanding from a low base. Structural barriers can be reinforced by restricted access to capital, regulatory uncertainty, and limited data availability, all of which slow the pace of necessary grid development and add to the challenge of integrating new loads such as EV charging, especially in the context of cross-sector growth in energy demand.

For example, in Brazil, the expansion of renewable power generation has significantly outpaced growth in transmission capacity. This has, at times, resulted in very [high curtailment levels](#), which limits how much electricity can be delivered to where it is needed. In India, [financial pressure](#) on state-owned utilities continues to limit their ability to invest in system upgrades and modernisation, and the combination of ageing distribution infrastructure and persistent electricity losses over the network reinforce these constraints. To address the gap between growing EV uptake and grid capacity, South Africa is deploying a network of [off-grid, solar powered fast charging stations](#) at planned intervals of 150 km along highways.

Across many emerging economies, the grid will need to expand to meet a wide range of growing demands, including rising household consumption, increased industrial electricity use, and the continued build-out of renewable generation. The broad scope of investments required mean there will be a need to bring transport planners, grid operators, regulators, and other energy stakeholders together around a common vision of EV deployment, so that growing transport demand is incorporated into planned grid expansions and upgrades, supporting a more resilient and cost-effective build-out.

# Chapter 11. Implications of the EV outlook

## Implications for the energy system

Electric vehicle (EV) adoption has important implications for the energy systems in places where vehicles are deployed. Of course, EVs increase electricity demand, but thanks to their higher energy efficiency compared to equivalently sized internal combustion engine vehicles (ICEVs), EVs result in net energy savings – oil displacement is even greater than additional electricity demand. There are other vehicle technologies and fuels that can also help reduce oil demand and emissions, including hybrid electric vehicles and the use of bio- or synthetic fuels. This chapter explores the energy and emissions implications of EV adoption in the Current Policies Scenario (CPS), Stated Policies Scenario (STEPS) and Net Zero Emissions by 2050 Scenario (NZE Scenario).

## Electricity demand

### Demand from electric vehicles could exceed 1 500 TWh by 2035

In 2025, the global fleet of EVs consumed around 250 TWh of electricity. As such, EVs accounted for about 1% of final electricity demand worldwide last year. As the stock of EVs grows more than fourfold by 2035 in the CPS, electricity demand increases around sixfold, exceeding 1 500 TWh. Around 85% of the increase in electricity demand for EVs in this scenario comes from the People's Republic of China (hereafter, "China") and Europe.

In the STEPS, electricity demand for EVs reaches 1 700 TWh in 2035, about 10% higher than in the CPS in that year. Growth in this scenario is driven by rising consumption from electric trucks and higher EV adoption in more markets. In the NZE Scenario, electricity demand for EVs surpasses 3 000 TWh globally over the same period.

Globally, electric light-duty vehicles (LDVs) remain the largest consumers of electricity for road transport through 2035 in all scenarios. However, the LDV share of road electricity demand falls from around 65% in 2025 to more than 60% by 2035 in the STEPS. In China, LDVs accounted for roughly 45% of demand from EVs in 2025, and this share reaches 50% in 2035, illustrating the country's widespread adoption of EVs across different vehicle segments in both scenarios.

In the United States, nearly all demand from EVs came from LDVs in 2025, and this share is maintained in the CPS, but falls to around 85% in the STEPS by 2035, as electricity use from electric trucks and buses grows. In Europe, increasing deployment of electric medium and heavy freight trucks pushes their share of electricity demand from EVs from around 5% in 2025 to around 20% by 2035 in both scenarios.

**Figure 11.1 Electricity demand by mode, region and scenario, 2025-2035**

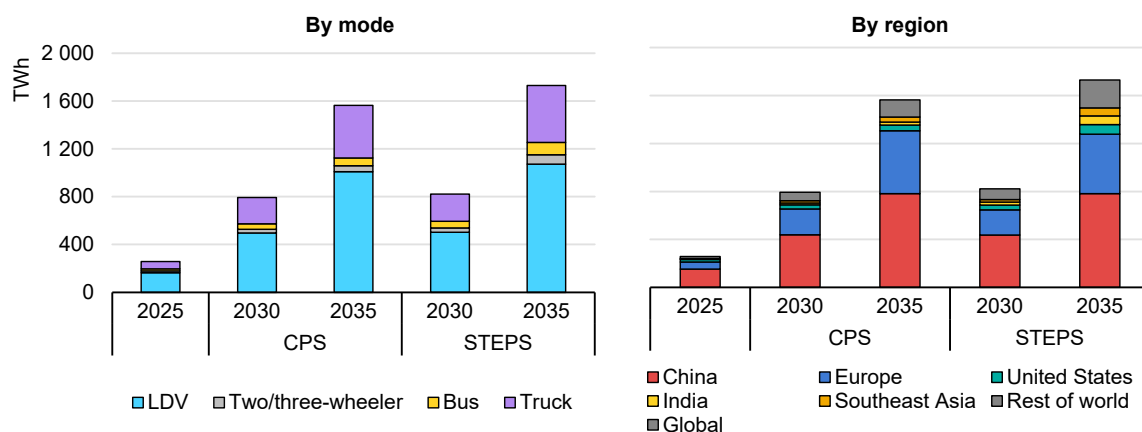

IEA. CC BY 4.0.

Notes: CPS = Current Policies Scenario; STEPS = Stated Policies Scenario; LDV = light-duty vehicle. The analysis is carried out for each region in the transport model within the IEA's [Global Energy and Climate Model](#) separately and then aggregated for global results. Regional data can be interactively explored via the [Global EV Data Explorer](#).

In both China and Europe, the share of electricity consumed by EVs reached around 1.5% of total electricity demand in 2025. By 2035, Europe's EV electricity demand share exceeds China's, as electricity consumption for other sectors, such as industry and buildings, grows more quickly in China. Globally, EVs represent about 5% of electricity demand by 2035 in the STEPS, compared to 4% in the CPS and around 7% in the NZE Scenario.

**Table 11.1 Share of electricity demand for EVs as a proportion of final electricity demand by region and scenario, 2025 and 2035**

Country	2025	Current Policies Scenario 2035	Stated Policies Scenario 2035
China	1.6%	5.8%	5.9%
Europe	1.7%	11.3%	10.8%
United States	0.5%	1.0%	1.7%
Japan	0.1%	0.6%	1.3%

Country	2025	Current Policies Scenario 2035	Stated Policies Scenario 2035
India	0.2%	0.8%	2.4%
Southeast Asia	0.3%	2.0%	3.2%
Latin America	0.2%	1.3%	2.9%
Global	0.9%	4.1%	4.6%

Notes: Total electricity demand is taken from the IEA's [Global Energy and Climate Model](#). Regional data can be interactively explored via the [Global EV Data Explorer](#).

## Oil displacement

### Electric vehicles could displace around 5 mb/d by 2030 based on current policies

For some countries, the energy security benefits of reducing dependency on oil – and especially on oil imports – have been at the heart of EV policy support. China, for example, is the world's largest importer of oil and home to the world's largest stock of EVs. Ethiopia is another prime example, where the government decided in 2024 to ban the import of ICEVs to mitigate the country's spending on oil imports – which [topped USD 4 billion](#) in 2022. Although it takes time for new EV sales to accumulate in the stock enough to make noticeable reductions in oil demand, the global fleet of EVs was responsible for displacing around 1.7 million barrels of oil per day (mb/d) in 2025 – equivalent to Indonesia's total oil demand in 2025. In China alone, EVs reduced oil demand by around 1 mb/d in 2025, which represents a reduction of around 15% compared to what road transport oil demand would have been if only ICEVs were on the road.

As soon as 2030, in both the CPS and STEPS, the oil displaced by EVs increases threefold to around 5 mb/d worldwide, bringing global oil demand for road transport down to around 44 mb/d. In the NZE Scenario, more than 7.5 mb/d of oil are displaced thanks to rapid EV adoption.

By 2035, EVs displace around 9 mb/d of diesel and gasoline in 2035 in the CPS. The oil displacement from EVs is about 1 mb/d higher in the STEPS, reaching around 10 mb/d in 2035. In both the CPS and STEPS, oil displacement in China reaches more than 4 mb/d in 2035, roughly 50% of the global total displacement. In the NZE Scenario, more than 15 mb/d of oil demand are avoided worldwide in 2035 due to EV deployment.

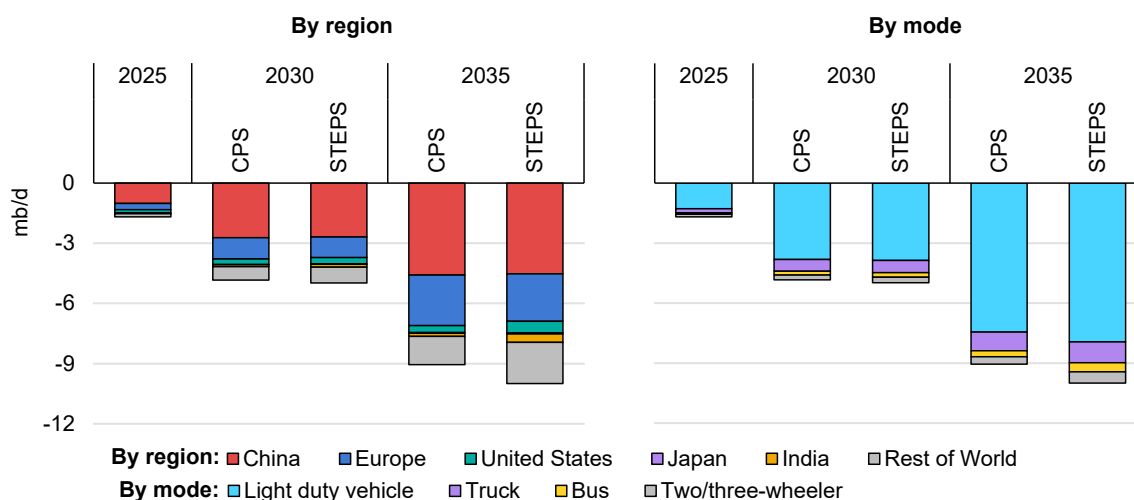
**Figure 11.2 Oil displacement by region, mode and scenario, 2025-2035**

IEA. CC BY 4.0

Notes: CPS = Current Policies Scenario; STEPS = Stated Policies Scenario; EVs provide mobility services that would otherwise be delivered by conventional fossil fuel-powered vehicles. Oil displacement is estimated based on the fuel consumption of internal combustion engine and hybrid electric vehicles required to travel the same distance. More detailed information on the methodology is provided in Annex A.

Electric LDVs were behind most of the oil displacement in 2025 (around 80%), though oil displacement due to the deployment of electric trucks in China represented more than 10%. In both the CPS and STEPS, LDVs are responsible for around 80% of the total oil displaced by EVs in 2035. Still, electric trucks and buses together displace around 1.3 mb/d in the CPS in 2035; in the STEPS, this is around 1.5 mb/d, and in the NZE Scenario, nearly 3.5 mb/d.

## Fuel tax revenue implications

### Electrification could reshuffle road fuel tax revenues

Globally, taxes on gasoline and diesel consumed for road transport generated an estimated USD 590 billion in revenue in 2025. For context, this is higher than the entire [2025 German federal budget](#). Fossil fuel taxes generated by road transportation can contribute significantly to total federal, and state, tax revenues. In a few emerging markets, [fuel taxes](#) contribute over 9% of total government revenues. In most countries, fossil fuel taxes account for between 4% and 8% of total government revenue, representing an important source of government income and highlighting the need to assess the future evolution of EV adoption and its impact on fossil fuel tax revenue.

In the United Kingdom, for example, road fossil fuel tax revenue is estimated to have totalled USD 31 billion in 2025, which is less than 5% of the central government's total [tax receipts](#) from the 2024-2025 tax year. Road transport fuel

taxes are also often used to fund road and other transport infrastructure. In the United States, for instance, fuel taxes on gasoline and diesel sales constitute the [largest contributions](#) to the Highway Trust Fund, which is used to fund the construction and maintenance of US highways, bridges and mass transit systems.

Electricity taxes tend to be lower than fossil fuel taxes, in most cases, and EVs consume less energy for covering the same distance compared to conventional vehicles. EV deployment could therefore result in net revenue losses for governments in the absence of tax system reform. In the CPS, global net tax revenue losses due to EV deployment rise from around USD 20 billion in 2025 to nearly USD 160 billion by 2035. In the STEPS, based on today's fuel tax frameworks, total losses remain similar to CPS levels by 2035. This reflects a decline of about USD 160 billion in global road fossil fuel tax revenues by 2035, only partially offset by roughly USD 25 billion in electricity tax revenues from EVs.

**Figure 11.3 Net tax implications of electric vehicle adoption by region and scenario, 2025-2035**

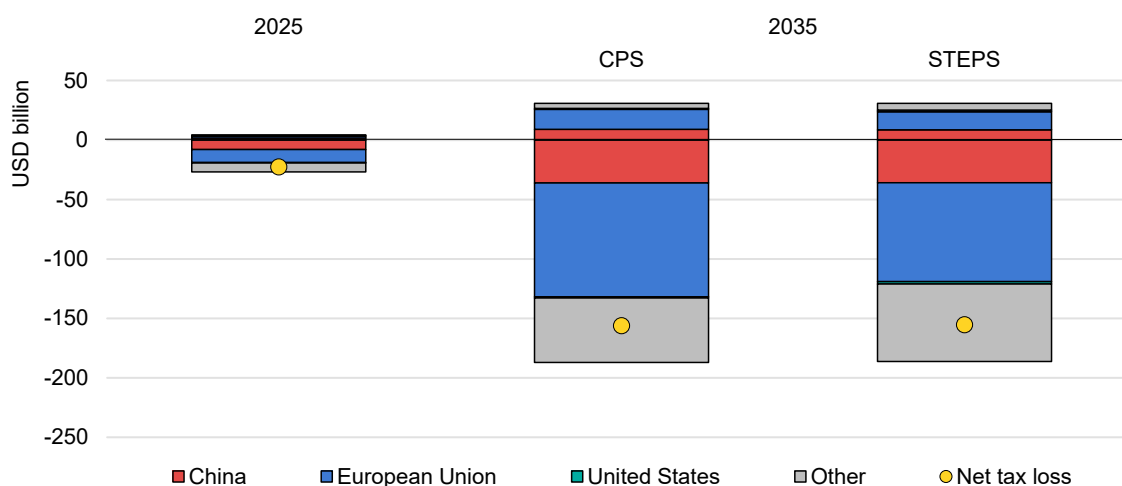

IEA. CC BY 4.0

Notes: CPS = Current Policies Scenario; STEPS = Stated Policies Scenario. Fuel tax rates are assumed to remain constant. Only federal tax rates are included.

Source: Analysis based on tax rates from [IEA Energy Prices](#).

Given the relatively high fossil fuel tax rates in the European Union, the region accounts for the largest share of road fuel tax losses, exceeding USD 80 billion in the CPS by 2035 as ICE vehicles are progressively displaced, leading to a decline in a fossil fuel tax revenue. In the STEPS, losses remain lower, at around USD 70 billion. This is because while EV adoption is faster in STEPS, the resulting decline in fossil fuel tax revenues is partially offset by electricity tax revenues. In China, vehicle-related fuel tax revenue losses increase from nearly USD 8 billion today to around USD 35 billion by 2035 in the CPS, with losses in the STEPS reaching a similar level.

In the United States, EVs represent less than 10% of the total vehicle stock in 2035 in the STEPS. Over that timeframe, total road transport activity increases by almost 10%, and so total road energy demand in 2035 is slightly higher than in 2025. As a result, the net tax losses remain at less than USD 1 billion in both the CPS and STEPS.

Outside of the three major EV markets, net road tax loss in aggregate in the STEPS increases to nearly USD 60 billion by 2035, compared to around USD 7 billion in 2025. However, the situation varies by country and region. For example, Japan's road fossil fuel tax revenue declines by nearly USD 7 billion in 2035 compared to 2025, as fleet electrification reaches nearly 10%. In India, on the other hand, fossil fuel tax revenue continues to grow to 2035 in the STEPS, as conventional vehicle stock increases over 10%. Many EMDEs tend to rely more heavily on fuel tax revenues, which increases their [fiscal exposure](#) to declining fuel consumption as electrification accelerates. However, in oil-importing countries, lost tax revenues could be balanced by reduced fuel import costs.

Longer-term measures to stabilise tax revenues will be needed in the transition to electromobility. Policy strategies could involve more wide-ranging tax reforms, such as coupling high taxes on carbon-intensive fuels with distance-based charges. Countries historically offering vehicle tax exemptions for EVs could also reinstate taxes as EVs become increasingly prevalent. This is already happening across a number of European countries: most regions in [France](#) ended registration tax exemptions for EVs in 2025, and the [United Kingdom](#) introduced vehicle excise duties for EVs for the first time in the same year. In 2026, the [Netherlands](#) reduced the discount on motor vehicle tax for battery electric vehicles, and will end it altogether from 2030. The impact of such measures on EV adoption depends on tax design. Taxes affecting upfront vehicle cost, such as registration or purchase-related charges, tend to [have a stronger effect on EV uptake](#), as they directly affect cost-competitiveness. By contrast, usage-based taxation has a more limited impact on adoption. In this context, countries such as [Iceland](#) and [Switzerland](#) have started to implement or plan for alternative tax systems based on road usage, including distance-based charging schemes.

## Emissions impacts

### Road transport emissions will remain above 6 Gt CO<sub>2</sub> to 2035 based on current policies

From 2015 to 2025, direct emissions from the road transport sector increased by almost 10% as vehicle activity (kilometres driven) increased by nearly 25%. This global increase in road transport emissions was driven by more than 35% growth in vehicle activity in EMDEs. At the same time, despite road activity growing over

10% in advanced economies, tailpipe emissions actually fell slightly in those economies, thanks to vehicle efficiency improvements and growing EV adoption. Battery electric vehicles are one of two vehicle technologies<sup>46</sup> available today that produce zero tailpipe emissions; plug-in hybrid electric vehicles produce no tailpipe emissions when driving in electric mode.

As vehicle efficiency continues to improve in regions with fuel economy and/or CO<sub>2</sub> standards, the average CO<sub>2</sub> intensity of driving is falling. In advanced economies, where a number of countries have enforceable standards in place governing future improvements – such as in Canada, the European Union, Japan, Korea and the United Kingdom – CO<sub>2</sub> emissions from road transport fall by 10% from 2025 to 2035 in the CPS, despite activity growing by more than 5%. In China, where there are also fuel economy standards in place and where electric car sales are increasingly market driven, direct road transport emissions fall by over a third from 2025 to 2035 in the CPS, while activity grows around 35%. Across EMDEs other than China, fuel economy and CO<sub>2</sub> standards are less common, and road transport emissions grow more than 30% over the next decade in the CPS, driving global road transport emissions up by over 2% by 2035.

**Figure 11.4 Direct emissions from road transport by scenario, 2015-2035**

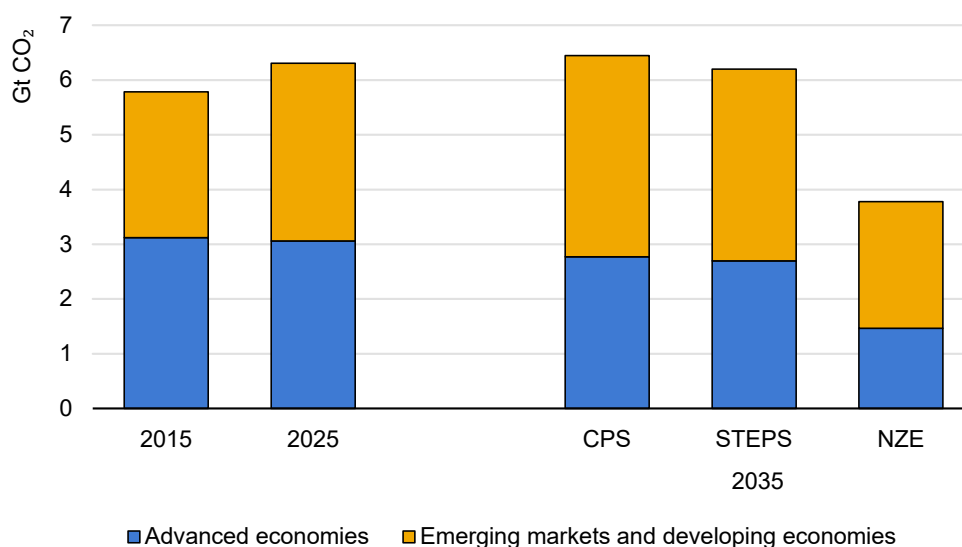

IEA. CC BY 4.0.

Notes: CPS = Current Policies Scenario; STEPS = Stated Policies Scenario; NZE = Net Zero Emissions by 2050 Scenario. Direct emissions refer to the tailpipe emissions from fossil fuel combustion; emissions from the combustion of biofuels are not included.

<sup>46</sup> Fuel cell electric vehicles also produce zero tailpipe emissions.

In the STEPS, EV deployment and vehicle efficiency improvements proceed somewhat faster globally than in the CPS. As a result, road transport emissions in 2035 are about 4% lower in the STEPS. Road tailpipe emissions in EMDEs outside of China still grow over the next decade in this scenario, increasing around 25% compared to 2025.

In the NZE Scenario, road transport emissions fall significantly by 2035, in both advanced and emerging economies. Globally, road transport emissions in 2035 are around 40% lower in the NZE Scenario than in the policy-based exploratory scenarios.

## Considering well-to-wheel emissions benefits, EVs avoid over 1 Gt of GHG emissions in 2035

Although EVs produce no tailpipe emissions when powered by electricity, there are still emissions associated with generating that electricity. Well-to-wheel emissions impacts can therefore be used to determine the net impact of EV adoption. This accounts for emissions savings from the displacement of fossil fuel demand for ICEVs and hybrid electric vehicles (HEVs), as well as the emissions generated by the electricity to power EVs.

In 2025, the stock of EVs was responsible for avoiding net emissions of 190 Mt CO<sub>2</sub>-equivalent (CO<sub>2</sub>-eq) – similar to the energy-related emissions of Spain. More than half of the current emissions savings are attributable to EV deployment in China, despite more than half of China's electricity generation coming from unabated coal. Around 40% of the net GHG emissions savings from 2025 were from EV deployment in advanced economies.

Over the next 10 years, growing EV adoption in the CPS results in the cumulative avoidance of approximately 7 Gt CO<sub>2</sub>-eq globally, with over 1.2 Gt CO<sub>2</sub>-eq avoided in 2035 alone. For reference, Japan's total energy-related CO<sub>2</sub> emissions in 2024 were 1 Gt. In the STEPS, net emissions reductions reach 1.4 Gt CO<sub>2</sub>-eq in 2035 (15% greater than in the CPS), but over the decade to 2035, an additional 600 Mt CO<sub>2</sub>-eq emissions are avoided compared to in the CPS. This is partly because the global average emissions intensity of electricity generation decreases more quickly in the STEPS than in the CPS, and is over 10% lower than in the CPS in 2035.

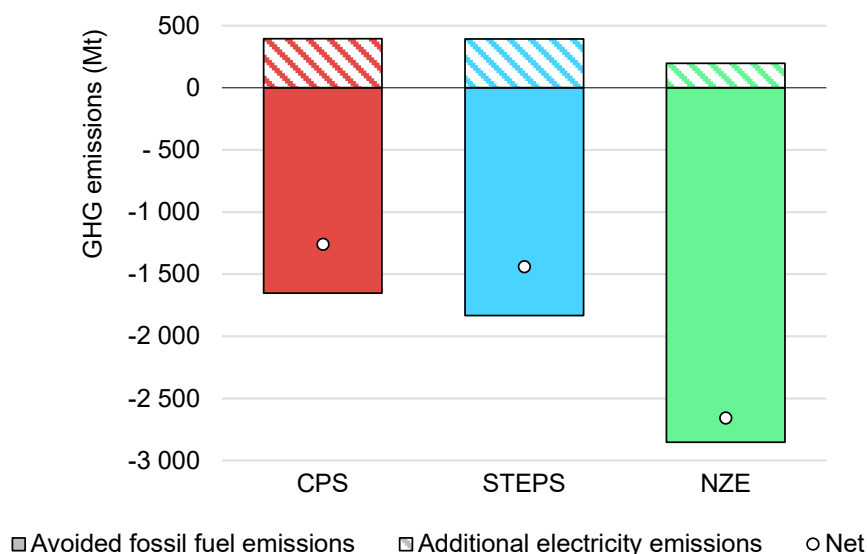
**Figure 11.5 Net avoided GHG emissions from electric vehicle deployment by scenario, 2035**

IEA. CC BY 4.0.

Notes: CPS = Current Policies Scenario; STEPS = Stated Policies Scenario; NZE = Net Zero Emissions by 2050 Scenario. Net GHG emissions are calculated as the total emissions from electricity generation, transmission and distribution (“additional electricity emissions”) and the negative emissions that the equivalent internal combustion engine vehicle and hybrid electric vehicle fleet would have emitted from both upstream supply and at the tailpipe (“avoided fossil fuel emissions”). Biogenic CO<sub>2</sub> emissions are not included. Projections include fuel economy improvements of conventional and electric vehicles as well as the growing share of renewable electricity generation, as described in the [World Energy Outlook 2025](#).

In the NZE Scenario, EVs contribute to cumulative net GHG emissions savings of 13 Gt CO<sub>2</sub>-eq from 2025-2035, 80% higher than the emissions savings in the CPS and about 70% higher than in the STEPS. The higher levels of EV adoption in the NZE Scenario are amplified by lower emissions associated with electricity generation: the global average emissions intensity of electricity generation in 2035 in the NZE Scenario is 70% lower than in the STEPS.

The electrification of cars is the main driver of emissions reductions across all scenarios. However, in the NZE Scenario heavy-duty electric vehicles, including trucks and buses, are responsible for avoiding over 2 Gt CO<sub>2</sub>-eq over the next decade – more than 15% of the cumulative emissions savings from EVs. In the CPS and STEPS, electric heavy-duty vehicles (HDVs) avoid 0.9 Gt CO<sub>2</sub>-eq and 1.1 Gt CO<sub>2</sub>-eq, respectively.

Do electric cars reduce emissions overall?

**GLOBAL AVERAGE LIFECYCLE EMISSIONS BY POWERTRAIN FOR MEDIUM-SIZED AND SUV CARS, 2025, STATED POLICIES SCENARIO**

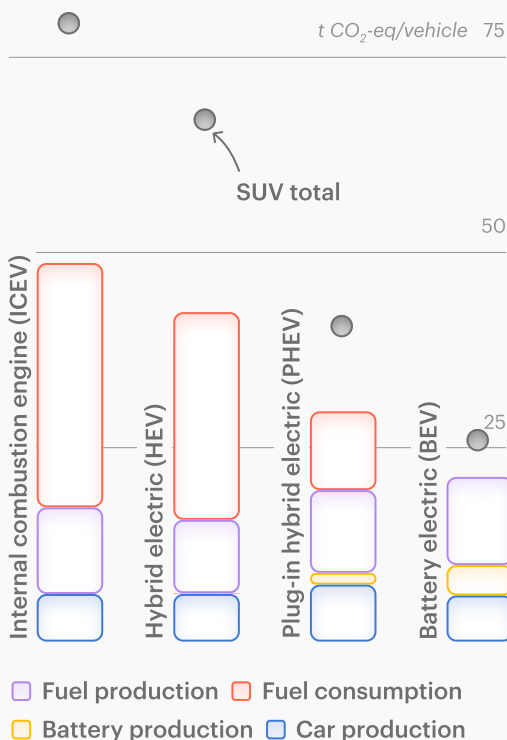

While the manufacturing of battery electric cars generates more emissions than conventional cars because of the EV battery production, they produce no tailpipe emissions during vehicle use. Even when accounting for the indirect emissions associated with electricity production, battery electric cars offer emissions savings compared to internal combustion engine (ICE) cars. Globally, the lifecycle GHG emissions of a medium-sized battery electric car, driving an average of 35 km per day over 15 years (roughly the global average), are more than 55% lower than a medium-sized gasoline ICE car, assuming electricity emissions evolve according to stated policies.

When comparing ICE and battery electric cars, higher upfront emissions attributed to the production of the battery are typically offset after around 2 years of use.

Compared with hybrid cars, battery electric cars have around 50% lower lifecycle emissions. The emissions associated with plug-in hybrid electric cars largely depend on the share of kilometres driven in electric mode. Assuming an electric-driving share of 60%, close to today's global average, the GHG emissions of a plug-in hybrid electric car are 30% lower than those of a non-plug-in hybrid, though around 40% higher than a battery electric car.

The GHG emissions savings delivered by electric cars also vary widely by region, depending on the electricity generation mix. Nonetheless, battery electric cars already deliver lifecycle emissions reductions. Even in countries with a high reliance on coal-fired power generation – and therefore among the most emissions-intensive electricity sectors globally – such as South Africa, India and China, electric cars have lower lifecycle emissions than comparable gasoline vehicles.

Higher annual driving distances further amplify these benefits, making electrification particularly impactful in high-mileage markets, such as the United States, where switching to a battery electric car can cut lifetime emissions by up to two-thirds for medium-sized cars.

Larger cars see relatively greater emissions benefits from switching to electric, reflecting the lower efficiency losses of electric vehicles as vehicle size increases. On average, a battery electric SUV emits around two-thirds less over its lifetime than an equivalent ICE vehicle.

**MEDIUM-SIZED BATTERY ELECTRIC AND INTERNAL COMBUSTION ENGINE CARS LIFECYCLE EMISSIONS BY COUNTRY, 2025, STATED POLICIES SCENARIO**

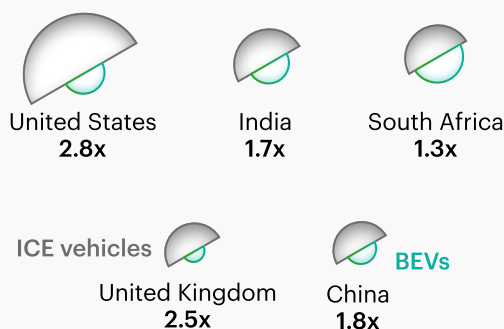

# Annexes

## Annex A: Oil displacement from electric vehicles

### Definition of oil savings

Electric vehicles (EVs) provide mobility services that would otherwise be delivered by conventional vehicles powered by fossil fuels. As a result, their deployment leads to a reduction in oil consumption.

### Methodology

Oil displacement is estimated based on the fuel consumption of conventional vehicles, namely internal combustion engine (ICE) vehicles and hybrid electric vehicles (HEVs), required to travel the same distance as the EV fleet.

Specifically, oil displacement is calculated by assuming that the total distance (in kilometres) travelled annually by EVs, disaggregated by vehicle type, would otherwise have been travelled by ICE vehicles or HEVs. For plug-in hybrid electric vehicles (PHEVs), which use both electricity and oil-based fuels, only the distance driven in electric mode is considered. This is determined using utility factor (UF) curves reported in the literature, which vary depending on battery size and the vehicle's electric driving range.

This methodology assumes that EVs replace ICE or hybrid vehicles within the same vehicle type, based on historical data and projected technology trends derived from the model. It also assumes that these vehicles exhibit similar driving behaviour.

## Fuel economy

Vehicle type	Powertrain	Fuel consumption of sales (test cycle), Lge/100km
Passenger car	Battery electric	1.8
Passenger car	Plug-in hybrid	3.3
Passenger car	Internal combustion engine	7.8
Passenger car	Hybrid vehicle	5.5
Light-commercial vehicle	Battery electric	2.8
Light-commercial vehicle	Plug-in hybrid	5.0
Light-commercial vehicle	Internal combustion engine	11.2
Light-commercial vehicle	Hybrid vehicle	7.7
Bus	Battery electric	10.1
Bus	Plug-in hybrid	16.1
Bus	Internal combustion engine	30.8
Bus	Hybrid vehicle	26.5
Medium freight truck	Battery electric	8.9
Medium freight truck	Plug-in hybrid	9.9
Medium freight truck	Internal combustion engine	23.1
Medium freight truck	Hybrid vehicle	20.1
Heavy freight truck	Battery electric	14.7
Heavy freight truck	Plug-in hybrid	26.8
Heavy freight truck	Internal combustion engine	40.9
Heavy freight truck	Hybrid vehicle	35.3
Two- or three-wheeler	Battery electric	0.4
Two- or three-wheeler	Internal combustion engine	1.7

Lge = litres of gasoline equivalent.

## Mileages

Vehicle type	Powertrain	Annual mileage (thousand km)
Passenger cars	Battery electric	12.5
Passenger cars	Plug-in hybrids	12.1
Passenger cars	Internal combustion engine	12.0
Passenger cars	Hybrid vehicles	12.8
Light-commercial vehicles	Battery electric	24.4
Light-commercial vehicles	Plug-in hybrids	23.3
Light-commercial vehicles	Internal combustion engine	16.2
Light-commercial vehicles	Hybrid vehicles	23.8
Buses	Battery electric	27.6
Buses	Plug-in hybrids	12.8
Buses	Internal combustion engine	19.9
Buses	Hybrid vehicles	36.4
Medium freight trucks	Battery electric	45.5
Medium freight trucks	Plug-in hybrids	26.9
Medium freight trucks	Internal combustion engine	22.7
Medium freight trucks	Hybrid vehicles	41.9
Heavy freight trucks	Battery electric	45.4
Heavy freight trucks	Plug-in hybrids	30.1
Heavy freight trucks	Internal combustion engine	37.2
Heavy freight trucks	Hybrid vehicles	28.2
Two- and three-wheelers	Battery electric	5.6
Two- and three-wheelers	Internal combustion engine	6.1

## Annex B: Definition of car size segment

Figure 1 Mapping of car size groups and vehicle segments

Car size	Segment	Car size	Segment
Small	Car-A	Large	Car-E
Small	Car-B	Large	Car-F
Small	MPV-A	Large	MPV-D
Medium	Car-C	Large	MPV-E
Medium	Car-D	Large	MPV-F
Medium	MPV-B	Large	SUV-B
Medium	MPV-C	SUV	SUV-C
Medium	SUV-A	SUV	SUV-D
		SUV	SUV-E
		SUV	SUV-F
		Pick-up truck	PUP-C
		Pick-up truck	PUP-D
		Pick-up truck	PUP-E

Notes: SUV = sport utility vehicle; MPV = multi-purpose vehicle; PUP = passenger pick-up truck.

A-, B-, C-, D-, and E-segments refer to vehicles with length equal or lower than 3.6 m, 4.1 m, 4.6 m, 4.8 m and 5.1 m, respectively. Longer vehicles belong to the F-segment category.

Source: Vehicle segment definition based on [EV Volumes](#).

## Annex C: Battery-related assumptions and methodological notes

If not stated otherwise, battery refers to lithium-ion battery.

### Battery market size

The market size (USD, 2025 MER) for lithium-ion batteries is calculated based on their deployment multiplied by its global unit price at the battery pack level. Market size reflects both the EV battery and battery storage markets. Stockpiling is excluded from the analysis.

### Battery manufacturing capacity

If not stated otherwise, battery manufacturing capacity refers to nameplate capacity of lithium-ion battery cell production. Manufacturing capacity not having as its primary application EVs or stationary energy storage systems – such as batteries for portable electronics – were excluded from the analyses. The average maximum output is assumed to be 85% of nameplate capacity. Committed refers to plants that have reached a final investment decision and are starting or have already started construction works, and preliminary to plants that have been announced but are not yet being built. Announced manufacturing capacity refers to the sum of committed and preliminary plants.

### N-1 analysis of lithium-ion batteries

An “N-1 analysis” has been conducted to assess overall supply security and resilience of the lithium-ion battery supply chains (Figure 7.15). Commonly used in power system studies, this method evaluates the consequences of losing the largest asset – in this case, the largest exporter of a given technology or component – regardless of the cause. The share of global demand that could still be met without the largest exporter, the People’s Republic of China (hereafter, “China”), is estimated using 2025 data and assuming that all other plants produce at their maximum theoretical average utilisation rate, here assumed to be 85% of their nameplate capacity. In this analysis, the global demand without the largest exporter is considered to be the deployment for the final technologies (EV sales and stationary battery storage installations outside of China – [other applications](#), such as portable electronics, are excluded). Stockpiling is excluded from the analysis. All facilities able to produce graphite anode suitable for battery applications are included within the scope of anode manufacturing capacity.

## Battery recycling capacity

Battery [recycling](#) is typically divided into two stages: pretreatment and material recovery. During pretreatment, batteries are discharged, dismantled and mechanically or thermally processed to prepare them for material recovery, usually producing “black mass.” This stage is the least complex and least costly. Black mass is a powder containing cathode and anode materials, including the valuable battery minerals. Material recovery refers to the extraction of these materials and metals from the black mass, and is the more technical and complex stage of recycling. It is typically carried out using pyrometallurgical, hydrometallurgical, or combined processes.

Recycling capacity refers to material recovery, and it is expressed in TWh by converting tonnage using the average energy density of battery cells sold 15 years earlier, reflecting the time lag between when EV and stationary-storage batteries enter service and when they reach end of life. For 2023 and 2025, an energy density of about 190 Wh/kg is used, while energy densities of 215 Wh/kg and 250 Wh/kg are used for 2030 and 2035, respectively. Data are shown as the maximum average output, which is assumed to be 85% of the recycling capacity.

## Battery electric car average on-road ranges

Range is calculated using the global sales-weighted average vehicle efficiency of battery electric vehicles and their battery capacity by size segment. The vehicle efficiency considered in calculations reflects on-road driving conditions by applying a factor of 1.1 to the Worldwide Harmonised Light Vehicle Test Procedure (WLTP) vehicle efficiency (in [kWh/100 km]). The range considers full battery utilisation, from 100% to 0% state of charge. Small cars include A and B segments; medium cars include C and D segments, A segments with SUV body type and B segments with multi-purpose vehicle (MPV) body type; large cars include E and F segments, B segments with SUV body type and D segments with MPV body type; SUV includes segments C to F with SUV body type and remaining segments with MPV body type.

## Battery electric car charging sessions

As a lithium-ion battery is recharged and its state of charge (SoC) increases, internal resistance rises and the risk of accelerated degradation from excessively fast charging increases. As a result, charging power is progressively reduced as the battery approaches higher SoC levels in order to protect battery lifetime and performance. Consequently, the power delivered during an EV charging session varies over time, following a declining profile as SoC increases (see table below for assumptions used in this regard). The range calculation shown in “Are electric cars suitable for long road trips?” assumes a vehicle with an on-road driving range

of 400 km (based on a mix of highway and urban driving), a battery capacity of around 67 kWh, and an on-road energy consumption of 16.8 kWh per 100 km. Full highway driving is assumed to result in a 10% increase in energy consumption relative to mixed driving conditions, and the charging session is assumed to begin at a battery state of charge of 10%.

**Table 1. Share of delivered nominal charging power as a function of the battery state of charge**

State of charge (%)	Percentage of nominal power delivered to the battery (%)
≤15%	100%
>15% and ≤35%	95%
>35% and ≤45%	90%
>45% and ≤50%	85%
>50% and ≤55%	75%
>55% and ≤60%	70%
>60% and ≤65%	65%
>65% and ≤70%	55%
>70% and ≤75%	45%
>75% and ≤80%	35%
>80% and ≤85%	30%
>85% and ≤90%	20%
>90% and ≤95%	15%
>95% and ≤100%	10%

Notes: Transitions between discrete delivered-power levels (for example, from 100% at 10% state of charge to 95% at 15% state of charge) are smoothed using linear interpolation. Specifically, the delivered-power share is interpolated linearly across the final 5 percentage points of state of charge of the preceding interval (e.g. between 10% and 15% state of charge).

## Battery material prices

Battery material prices (Figure 5.3) are retrieved from Bloomberg New Energy Finance and use the following tickers: Cobalt sulphate (BTCNMEQD), graphite sphere (GPCNAMZE), lithium carbonate (L4CNMJGO), and nickel sulphate (N3CNFRQV).

## Annex D: Total cost of ownership analysis for trucks

The truck total cost of ownership (TCO) analysis of Chinese diesel and battery electric trucks in Box 4.1 uses the same inputs and assumptions as listed in the Annex of the [Global EV Outlook 2025](#). Specific assumptions for the newly added natural-gas-powered truck case are listed below.

### Driving and refuelling profile

The daily driving range is assumed to be 500 km, where half of the daily distance is travelled before the driver's rest period and the other half afterwards. It is assumed that all truck types refuel during the rest periods. Regulations require rest periods durations of 20 minutes in China. It is assumed that the diesel trucks can sufficiently refuel within the rest periods, and thus incur no dwell costs (see below for how dwell costs are calculated for battery electric). En route charging is assumed to occur with 350 kW chargers. Battery electric trucks are also assumed to charge overnight, up to 10 hours, using a 50 kW (peak) charger. It is assumed that the trucks can operate seven days per week, forty-eight weeks per year for a total of 168 000 km travelled per year.

### Dwell costs for battery electric trucks

Maximum and minimum charge levels of 20% and 80% are maintained to preserve battery health and for enhanced safety. Battery electric trucks are assumed to charge for the full length of their rest period and during their stay in depot. If required, the battery electric truck remains charging after the rest period until the state of charge is sufficient to complete the remaining 250 km to return to depot, charge overnight at the depot, and then complete the 250 km required to reach the rest period the following day. This additional daily charging, if required, is multiplied by labour cost to give the dwell cost.

### Financing period and additional considerations

The truck is purchased with a 100% loan at 5% interest. A discount rate of 8% is applied throughout. The analysis takes into account the first 5 years after the purchase of the truck, equivalent to a total distance travelled of 840 000 km. Trucks, regardless of powertrain, are assumed to have a residual value of 26% throughout.

### Sensitivity case parameters

Error bars in Box 4.1 TCO figure represent the results of a sensitivity analysis carried out on charger utilisation for battery electric trucks (see Annex to the [Global](#)

[EV Outlook 2025](#) for parameters) and on LNG price for natural-gas-powered trucks. LNG [prices](#) for heavy-duty trucking in China averaged around USD 0.65/kg in 2025, with significant volatility, occasionally [pushing](#) prices above USD 1.2/kg during peak periods.

## Vehicle production costs and specifications

**Table 2. Truck powertrain components used in the analysis**

Powertrain type	Component	Value
ICEV Diesel	Engine power	325 kW
	Electric drive power	350 kW
BEV	Battery pack size	800 kWh
	On-board charger	44 kW
ICEV LNG	Engine power	325 kW
	Cryogenic storage tank size	1 000 L

Notes: ICEV = internal combustion engine vehicle; BEV = battery electric vehicle; LNG = liquified natural gas. Powertrain sizing values are for a United States class 8 (or equivalent) tractor truck.

Sources: Diesel engine power and battery electric battery pack size are adapted from [National Renewable Energy Laboratory](#), electric drive power and on-board charger sizes are taken from [Riccardo](#).

**Figure 2 Estimated purchase price of a heavy-duty truck in China used in the analysis, USD 2025**

	BEV	ICEV Diesel	ICEV LNG
<b>Finished chassis and cab</b>	14 000	14 000	14 000
<b>Powertrain</b>	25 800	22 800	22 800
<b>Battery</b>	68 900	-	-
<b>LNG tank</b>	-	-	14 100
<b>Manufacturing and assembly</b>	3 300	2 600	3 600
<b>Indirect costs and margins</b>	40 300	14 200	19 600
<b>Total (USD)</b>	<b>152 200</b>	<b>53 500</b>	<b>74 100</b>

Notes: ICEV = internal combustion engine vehicle; BEV = battery electric vehicle; LNG = liquified natural gas. Costs are for a United States class 8 (or equivalent) tractor truck with a 350 kW electric drive unit, and an 800 kWh battery. LNG storage tank costs are from [Horizon Insights](#). Powertrain includes the electric drive unit, electronics and thermal management units, on-board charger, and all balance of plant. Manufacturing and assembly costs are assumed to be 3% of production costs of the components, with indirect costs and margins of 36% of the total production cost, equally applied across all regions. All values are rounded to the nearest USD 100. The bottom-up calculated totals were validated against values from [ICCT](#).

Sources: Values for the share of total costs from the driveline, cab, and chassis; from manufacturing and assembly costs; and from indirect costs and margins are adapted from [Riccardo](#).

**Figure 3 Maintenance, insurance and labour costs for battery electric and ICE trucks in China, USD 2025**

	Maintenance USD/km	Insurance %	Labour USD/hour
<b>ICEV (Diesel and LNG)</b>	0.18	3.0%	11.6
<b>BEV</b>	0.13	3.6%	11.6

Notes: ICEV = internal combustion engine vehicle; BEV = battery electric vehicle; LNG = liquified natural gas. Maintenance costs are the same in years 1-5. Insurance costs are expressed as a share of the capital cost of the truck and represent the first year's premium; every year thereafter premiums fall by 2.5% for diesel and LNG trucks, and 3.5% for battery electric trucks. These figures are estimates derived from stakeholder engagement. Figures for labour cost are inclusive of employer's contributions.

Sources: Maintenance costs are adapted from [UC Davis](#), labour costs are adapted from the [Economic Research Institute](#).

## Energy prices and fuel economy

**Figure 4 Prices of diesel, electricity and natural gas, 2025**

Fuel	Units	Price
<b>Diesel</b>	USD/kWh	0.11
<b>Diesel</b>	USD/L	1.10
<b>Electricity</b>	USD/kWh	0.08
<b>LNG</b>	USD/kWh (min – max)	0.048 (0.043 – 0.094)
<b>LNG</b>	USD/kg (min – max)	0.65 (0.58 – 1.27)

Notes: LNG = liquified natural gas. Underlying electricity prices are the same at both the depot and during en-route charging, with the difference between them due exclusively to the differences in the infrastructure costs. (min – max) values are used in the LNG operating cost sensitivity analysis.

**Figure 5 Fuel economy of diesel, battery electric and natural gas heavy-duty trucks, 2025**

Powertrain	Units	Fuel economy
<b>Diesel ICEV</b>	kWh/km	3.5
<b>Diesel ICEV</b>	L/100 km	35.2
<b>BEV</b>	kWh/km	1.6
<b>LNG ICEV</b>	kWh/km	3.8
<b>LNG ICEV</b>	kg/100 km	28.3

Notes: ICEV = internal combustion engine vehicle; BEV = battery electric vehicle; LNG = liquified natural gas. BEV fuel economy based on a charging efficiency of [97.5%](#).

## Annex E: Costs and financial assumptions for home charging and gasoline refuelling

### Methodology to calculate annual operating costs for BEV and ICEV

Annual operating costs for battery electric vehicles (BEVs) and internal combustion engine vehicles (ICEVs) are estimated using the following assumptions:

- Local gasoline prices and home charging costs come from the IEA's [End-Use Prices Data Explorer](#).

**Table 3. Electric vehicle home charging costs (USD, 2025/kWh), 2020 – 2025**

Region	2020	2021	2022	2023	2024	2025
China	0.08	0.09	0.09	0.09	0.08	0.08
United Kingdom	0.29	0.35	0.45	0.48	0.42	0.46
United States	0.16	0.16	0.16	0.17	0.17	0.18

Note: For home charging residential electricity prices from the [End-Use Prices Data Explorer](#).

**Table 4. Gasoline prices (USD 2025/litre), 2020 - 2025**

Region	2020	2021	2022	2023	2024	2025
China	0.96	1.08	1.22	1.10	1.08	1.00
United Kingdom	1.77	2.19	2.33	1.97	1.87	1.84
United States	0.70	0.93	1.14	0.98	0.90	0.85

- ICEV and BEV are assumed to drive the same annual distance, although this varies across the analysed regions based on the average annual mileage in 2025 for each region.
- Average on-road fuel consumption values in each region as in the table below, derived from IEA's [historical road database](#).

**Table 5. Vehicle fuel economy and annual distance driven per region**

Region	kWh/km	Lge/100km	km/year
China	0.16	5.3	8 000
Europe	0.21	3.3	10 000
United States	0.19	9.9	17 000

Notes: Lge = litre of gasoline equivalent. 1 Lge = 9.302 kWh. Fuel economy values are based on weighted average for the specific regions for passenger cars.

Sources: [IEA historical road database](#).

## Methodology to estimate investments for private and public charging points

Investment needs for public and private charging infrastructure are estimated based on charger stock projections from the [Global Energy and Climate model](#). Charger stock evolves assuming a 15-year lifetime; retired chargers are replaced on a one-to-one basis, with replacements always upgraded to faster models. Charger costs decline gradually as deployment expands, subject to a lower bound beyond which further cost reductions are not expected. This dynamic is represented using cumulative gross installations and a floor-adjusted learning curve. The learning exponent  $\beta$ , derived from the specified learning rate and the floor cost, remains constant over time and is defined for each charger type and aggregate region as:

$$\beta = \frac{\ln\left(\frac{(1-l) - \frac{E}{C_{2025}}}{1 - \frac{E}{C_{2025}}}\right)}{\ln(2)}$$

- $l$  is the learning rate (7% for slow chargers and 10% for fast chargers)
- $E$  is the floor cost of a charger
- $C_{2025}$  is the cost of equipment in the year 2025.

The tables below present assumptions for charger purchase and installation costs in China, Europe and the United States, as well as in other regions. The costs of equipment in 2025 represent the per-unit expense of producing or procuring a charger, excluding installation. The floor cost sets the minimum projected cost level, toward which estimates converge in regions with rapid innovation or low starting costs. Installation cost reflects the fixed expense of installing a unit; it is not part of the cost-evolution calculation and is added directly to the total cost of each installed charger.

**Table 6. Electric vehicle charging equipment costs in China, USD 2025**

Speed (kW)	Equipment costs in 2025	Installation costs	Floor price
> 22	120	170	100
22 - 50	1 670	150	1 400
50 - 150	4 620	2 100	3 900
150 - 350	27 900	8 400	19 600
350 – 1 000	50 800	20 000	43 200
1 000+	145 000	58 800	123 300

Notes: Values are rounded. Installation costs only refer to the costs made during installation and do not include land purchase or rent; as such, private and public installations are equivalent.

Sources: [Iyanbao](#), [HWABAO Securities](#), [Chd-IN-EN](#).

**Table 7. Electric vehicle charging equipment costs in Europe, USD 2025**

Speed (kW)	Equipment costs in 2025	Installation costs	Floor price
>22	670	1 950	570
22 - 50	2 280	2 790	1 900
50 - 150	31 200	16 700	26 600
150 - 350	55 800	22 300	47 400
350 – 1 000	134 000	53 500	113 600
1 000+	392 000	156 800	333 200

Notes: Values are rounded. Installation costs only refer to the costs made during installation and do not include land purchase or rent; as such, private and public installations are equivalent.

Sources: [ACEA](#), [BEEV](#), [CEER](#), [Tsiropoulos, Siskos & Capros](#) (2022).

**Table 8. Electric vehicle charging equipment costs in the United States, USD 2025**

Speed (kW)	Equipment costs in 2025	Installation costs	Floor price
>22	550	510	470
22 - 50	2 800	2 570	2 400
50 - 150	41 100	41 100	34 900
150 - 350	77 000	51 300	65 400
350 – 1 000	171 000	123 000	146 000
1 000+	503 000	361 000	427 000

Notes: Values are rounded. Installation costs only refer to the costs made during installation and do not include land purchase or rent; as such, private and public installations are equivalent.

Sources: [RMI](#), [ICF](#), [AFDC](#), [Borlaug, Salisbury, Gerdes and Muraotri](#) (2020).

**Table 9. Electric vehicle charging equipment costs outside China, Europe and the United States, USD 2025**

Speed (kW)	Equipment costs in 2025	Installation costs	Floor price
> 22	360	700	180
22 - 50	2 100	1 400	1 400
50 - 150	20 400	15 500	10 200
150 - 350	44 700	22 600	22 300
350 – 1 000	102 000	54 100	50 800
1 000+	296 000	158 800	148 100

Notes: Values are rounded. Installation costs only refer to the costs made during installation and do not include land purchase or rent; as such, private and public installations are equivalent. For regions outside the major markets, initial and installation costs are estimated using a weighted average of data from China, Europe and the United States. The floor price is defined as the higher of either the floor price observed in China or 50% of the initial capital cost.

## Cash flow model

### Charging station archetypes

The cash flow model was built around four archetypes. The fast-charging archetype assumes 4 charge points at 150 kW (600 kW) and the ultra-fast station assumes 4 charge points at 400 kW (2.4 MW). Both types of charging stations can be located either in urban areas or near to a highway. The model is calibrated for Germany. Retail charging prices are assumed at [EUR 0.80/kWh](#) and wholesale electricity prices at [EUR 0.10/kWh](#), to which grid fees (variable and capacity fee) are added, resulting in a price of approximately EUR 0.2-0.3/kWh. Electricity sales are calculated from installed capacity based on 8 760 operating hours per year, and a derating factor of 90%. Utilisation rates are modelled using a logistic (S-curve) function calibrated to the projected growth of the EV fleet in Germany. The approach captures the gradual build-up in demand typically observed in the early years of charging infrastructure deployment. Utilisation starts at low levels in the first years of operation and increases as the EV fleet expands, before converging towards a long-run level of 15%.

### Capital expenditure and grid connection modelling

Capital costs include chargers, installation, grid connection and civil works. Operating costs include electricity purchases, network charges, maintenance and site rent. The grid connection costs have been calculated for the different archetypes. Highway sites are assumed to require connection to a 10 kV distribution network located approximately 10 km from the charging site, while urban sites are assumed to connect to an existing medium-voltage distribution network. These assumptions capture differences in network reinforcement and

connection distance that typically make highway or remote connections more expensive. Connection costs are then applied to each station archetype and scaled according to the installed charging capacity.

## Annex F: Battery swapping station assumptions

Table 10. Number of battery-swap capable vehicles and battery-swap stations by country or region, 2025

Country	Estimated model availability	Estimated inventory of compatible vehicles	Estimated stations/cabinets	Primary market
China	Trucks: 40 – 60 models Cars: 8 models	<a href="#">1 million</a> cars <a href="#">100 000</a> trucks <a href="#">13 000 000</a> 2/3Ws	Trucks: <a href="#">1 000+</a> Cars: <a href="#">3 700+</a> 2/3Ws: estimated at 4 000	Cars, trucks
Chinese Taipei	Over <a href="#">55 2/3W models</a>	<a href="#">600 000+</a> swap-capable scooters	<a href="#">12 500</a>	2/3Ws
Europe	7 – 10 car models	<a href="#">5 000</a> cars	<a href="#">60</a>	Cars
India	<a href="#">10 – 20 2/3W models</a>	<a href="#">60 000</a> 2/3Ws <a href="#">50</a> trucks	2/3Ws: <a href="#">2 500</a> Trucks: <a href="#">8 – 10</a> planned	2/3Ws, trucks
Indonesia	<a href="#">10+</a> motorcycle models	<a href="#">At least 250 000</a> 2Ws	<a href="#">approx. 1 400</a>	2/3Ws
Kenya	2 - 4 2/3W models	approx. 9 000 2/3Ws*	approx. 400	2/3Ws
Korea	Cars: 1 model	<a href="#">20 cars</a>	1	Cars, LCVs
Rwanda	<a href="#">8</a> 2/3W models	<a href="#">4 000</a> 2/3Ws	<a href="#">At least 100</a>	2/3Ws
Thailand	<a href="#">10+ models 2/3Ws</a>	<a href="#">4 200 trucks</a> planned; <a href="#">Approx. 1 000</a> 2/3Ws	213 <a href="#">in Bangkok</a>	2/3Ws
Uganda	2 – 4 2/3W model	<a href="#">950</a> 2/3Ws	<a href="#">134</a>	2/3Ws
United States	Pilots only	n/a	n/a	Cars

\* Based on sources for [ARC Ride](#), [Spiro](#) and [Ampersand](#).

Note: China sales are based on total sales of battery-swap-capable car models since 2018 from EV Volumes.

**Table 11. Battery swapping station battery sizes and number of batteries per station**

Country/Region	Mode	Battery size (kWh)	Average number of batteries per station	References
China	Trucks	210	21	<a href="#">CHEVPost, 2025</a>
China	Cars	100	48	<a href="#">CATL, 2022</a>
China	2/3 wheelers	5	21	<a href="#">TYCORUN</a>
Chinese Taipei	2/3 wheelers	5	30	<a href="#">GOGORO</a>
Europe	Cars	100	21	<a href="#">CNEVPost, 2023</a>
India	2/3 wheelers	5	15	<a href="#">SUNMobility</a>
India	Trucks	282	21	<a href="#">Times of India, 2025</a>
Indonesia	2/3 wheelers	5	30	<a href="#">ITDP, 2024</a>
Kenya	2/3 wheelers	5	12	<a href="#">ARC Ride</a>
Korea	Cars	100	21	<a href="#">The Chosun Daily, 2025</a>
Rwanda	2/3 wheelers	5	12	<a href="#">World Resources Institute, 2024</a>
Thailand	2/3 wheelers	5	12	<a href="#">Honda</a>
Uganda	2/3 wheelers	5	12	<a href="#">Spiro</a>

## Annex G: Automaker electrification targets

**Table 12. Automaker electrification targets for car sales used in the carmaker electrification analysis**

Automaker	Target	Region	Group or brand
<b>General Motors (GM)</b>	100% ZEV sales by 2035 in leading markets	Global	Group
	40-50% ZEV sales by 2030	United States	Group
<b>Ford</b>	Manufacturing rate of 600 000 EVs in 2026. Around 50% of sales to be HEVs and EVs by 2030; 100% ZEV sales by 2035 in leading markets	Global	Group
	More than 600 000 BEV sales in 2026	Europe	Group
	40-50% ZEV sales by 2030	United States	Group
<b>Tesla</b>	20 million BEV sales by 2030 (target is now flexible)	Global	Group
	50% BEV sales by 2030	Global	Group
<b>Volkswagen</b>	BEV sales of 80% in 2030 and 100% from 2033	Europe	Brand
	BEV sales of 55% by 2030	United States	Brand
	BEV sales of 50% by 2030	China	Brand
<b>Audi</b>	BEV sales of 100% from 2033 (target is now flexible)	Global (excl. China)	Brand
<b>Bentley</b>	BEV-only sales by 2035 (could extend to inclusion of PHEVs in response to positive customer demand)	Global	Brand
<b>Porsche</b>	80% of BEV sales by 2030 (target is now flexible)	Global	Brand
<b>Škoda</b>	50-70% of BEV sales by 2030	Europe	Brand
<b>Stellantis</b>	BEV sales of 5 million by 2030	Global	Group
	40-50% ZEV sales by 2030	United States	Group
<b>Lancia</b>	100% EV sales by 2028	Europe	Brand
<b>BMW</b>	33% by 2026 and 50% BEV sales by 2030 depending on the market situation	Global	Brand
<b>Mercedes-Benz</b>	50% EV sales by 2030 and 100% ZEV sales by 2035 in leading markets	Global	Group
<b>Renault</b>	100% EV by 2030 (target is now flexible)	Europe	Brand
<b>Dacia</b>	100% EV by 2035	Europe	Brand
<b>Ampere</b>	1 million BEV sales in 2031	Europe	Brand
<b>Toyota</b>	Sell 3.5 million BEVs in 2030 (around 32% of sales share) and expectations of 1 million BEV sales by 2027	Global	Group
	BEV sales to exceed 250 000 per year and over 20% of BEV mix by 2026	Europe	Brand

Automaker	Target	Region	Group or brand
Lexus	BEVs to make up 100% of sales in 2035	Global	Brand
	BEVs to account for 100% of sales by 2030	Europe, United States and China	Brand
Honda	ZEVs to represent less than 30% of sales by 2030, 80% in 2035 and 100% by 2040. Produce more than 2 million EVs by 2030	Global	Group
	100% EV sales by 2035	China	Group
Nissan	40% sales of EV and HEV sales by 2026 and 60% by 2030	Global	Group
	100% BEV sales by 2030 (target is now flexible)	Europe	Group
	40% BEV sales by 2030	United States	Group
	58% EV and HEV sales by 2026	Japan	Group
Mazda	35% EV and HEV sales by 2026	China	Group
	24-50% EV sales in 2030	Global	Group
Subaru	200 000 BEV sales in 2026 and 600 000, representing 50% of sales, by 2030	Global	Group
Mitsubishi	50% of sales to be EV and HEV by 2030 and 100% by 2035	Global	Group
Suzuki	80% BEV sales by 2030	Europe	Group
	20% BEV sales by 2030	Japan	Group
	15% BEV sales by 2030	India	Group
Hyundai, Genesis	ZEV and HEV sales of 3.3 million by 2030 and sell only EVs in main markets by 2040	Global	Brand
	Sell only EVs by 2035	Europe	Brand
Kia	EV sales of 1 million, representing 25% share by 2026; EV sales of 1.26 million, representing 38% share by 2030	Global	Brand
Tata	25% EV sales share by 2028 and 30% by 2030	Global	Brand
Jaguar	EV-only brand by 2030 (target is now flexible)	Global	Brand
Land Rover	60% BEV sales by 2030 and 100% by 2036	Global	Brand
Geely	2.22 million NEV sales in 2026, representing 64% share	Global	Group
Volvo	90% EV sales by 2030 and 100% ZEV sales by 2035 in leading markets	Global	Brand
Changan	1.4 million NEV sales in 2026 and 3.5 million in 2030, representing 60% sales share by 2030	Global	Group
BYD	1.3 million EV sales outside China in 2026	Global	Group
FAW	NEV sales of 60% by 2030	Global	Group
Xiaomi	550 000 NEV deliveries in 2026	Global	Brand

Automaker	Target	Region	Group or brand
<b>NIO</b>	456 000 to 489 000 NEV sales in 2026	Global	Group
<b>Leapmotor</b>	1 million NEV sales in 2026	Global	Group
<b>Harmony Intelligent Mobility Alliance</b>	1 to 1.3 million NEV sales in 2026	Global	Brand
<b>X Peng</b>	550 000 to 600 000 NEV sales in 2026	Global	Group
<b>Li Auto</b>	550 000 NEV sales in 2026	Global	Group
<b>Dongfeng</b>	1.7 million NEV sales in 2026, including 600 000 exports	Global	Group
<b>Chery</b>	40% NEV sales by 2030	Global	Group

Notes: BEV = battery electric vehicle; PHEV = plug-in hybrid vehicle; EV = electric vehicle, which includes BEVs and PHEVs; ZEV = zero emissions vehicle, which includes EVs and fuel cell electric vehicles; NEV = new energy vehicle, which includes BEVs and PHEVs; HEV = hybrid electric vehicle (non-plug-in).

## Annex H: Estimating flexibility potentials for V2G

### Definition of hourly energy flexibility

The positive and negative hourly energy flexibility is defined as

$$\text{Hourly energy flexibility}_{+/-} = \min ( P_{\max,+/-} \Delta t, \Delta EFL ).$$

Here  $P_{\max,+/-}$  is the maximum power draw and power feed from and to the grid,  $\Delta t$  is the considered time span, i.e. one hour, and  $\Delta EFL$  is the difference between upper and lower energy flexibility limit. The energy flexibility limits define how much energy can be (upper limit) and must at least be (lower limit) drawn from the grid over the course of a day. The main parameters determining energy and power limits are battery capacity, driving and charging patterns for EVs as well as heating needs, temperature flexibility and buffer tank dynamics for heat pumps. The limits are determined by considering a pool of 100 units to account for the variation in driving and charging patterns for EVs and in renovation status for buildings.

### Modelling assumptions

#### Electric Vehicles:

- Representative driving and charging patterns based on [Mobility Survey in Germany](#) for moderate weather on a weekday.
- Average driving distance: 47.7 km; average time at home: 18h 23 minutes; average state of charge at arrival: 88.4%.
- Flexibility is only considered when vehicle is at home; every vehicle has a charging point at home; vehicles are always plugged in when at home.
- 60 kWh battery capacity; Target state of charge: 100%, Minimum state of charge: 25%; 11 kW bidirectional charging/discharging power.

#### Battery energy storage system:

- Battery always available for charging and discharging.
- 7.5 kWh battery capacity; 7.5 kW charging/discharging power.

#### Heat pumps:

- [Thermal building models](#) to determine room temperature and heat demand.
- Flexibility is only considered in the provision of space heating in residential buildings.
- Flexibility thanks to heat pump's thermal buffer storage tank and permitted deviations of 0.5°C from the target room temperature.
- Monovalent air-to-water heat pumps.
- Buildings have mixed state of renovation representative of German building stock.

# Annex I: Glossary

## Abbreviations and acronyms

ACEA	European Automobile Manufacturers' Association
ACAU	Asociación del Comercio Automotor del Uruguay
ACUA	Asociación de Concesionarios de Uruguay
AE	advanced economies
AFDC	Alternative Fuels Data Center
AIRIA	Automotive Industry Research Institute of India
ASEAN	Association of Southeast Asian Nations
BEV	battery electric vehicle
BESS	battery energy storage system
BF-BOF	blast furnace–basic oxygen furnace
BTS	Bureau of Transportation Statistics
CAD	Canadian dollar
CATARC	China Automotive Technology and Research Center
CBS	Central Bureau of Statistics (Netherlands)
CCS	Combined Charging System
CNG	compressed natural gas
CO <sub>2</sub>	carbon dioxide
CO <sub>2</sub> -eq	carbon dioxide equivalent
CPCA	China Passenger Car Association
CPS	Current Policies Scenario
DLT	Department of Land Transport (Thailand)
DRC	Democratic Republic of the Congo
EAFO	European Alternative Fuels Observatory
EBIT	earnings before interest and taxes
EGMP.S	Electric Global Modular Platform for commercial vehicles
EMDE	emerging markets and developing economies
EREV	extended-range electric vehicle
EU	European Union
EUR	euro
EV	electric vehicle
EVSE	electric vehicle supply equipment
FAME-II	Faster Adoption and Manufacturing of Electric Vehicles Phase II (India)
FCEV	fuel cell electric vehicle
FMO	Nederlandse Financierings-Maatschappij voor Ontwikkelingslanden (Dutch Entrepreneurial Development Bank)
FTA	free trade agreement
GDP	gross domestic product
GEVO	Global EV Outlook
GHG	greenhouse gas

GST	goods and services tax
HDV	heavy-duty vehicle
HEV	hybrid electric vehicle
HFT	heavy freight truck
HRS	hydrogen refuelling station
IAA	Industrial Action and Automotive Package
ICE	internal combustion engine
ICEV	internal combustion engine vehicle
IRA	Inflation Reduction Act (United States)
ITF	International Transport Forum
JV	joint venture
KBA	Kraftfahrt-Bundesamt (German Federal Motor Transport Authority)
LFP	lithium iron phosphate
LDV	light-duty vehicle
LNG	liquefied natural gas
LTA	Land Transport Authority (Singapore)
MAA	Malaysian Automotive Association
MBBL	Model Building Bye-Laws (India)
MFT	medium freight truck
MSRP	manufacturer's suggested retail price
NCX	lithium nickel cobalt X (battery chemistry category)
NEV	new energy vehicle
NMC	lithium nickel manganese cobalt oxide
NOx	nitrogen oxides
NZE	Net Zero Emissions by 2050 Scenario
NZTA	New Zealand Transport Agency
OBBBA	One Big Beautiful Bill Act (United States)
ODA	official development assistance
OEM	original equipment manufacturer
OICA	Organisation Internationale des Constructeurs d'Automobiles
ÖTV	Special Consumption Tax (Türkiye)
PBA	Prussian blue analogue
PHEV	plug-in hybrid electric vehicle
PM E-DRIVE	Prime Minister Electric Drive Revolution in Innovative Vehicle Enhancement (India)
PM-eBus SEWA	Prime Minister eBus Service and Welfare Assistance scheme (India)
PV	photovoltaic
RoW	rest of world
SEPP	Subsidy scheme for electric passenger cars (Netherlands)
SiC	silicon carbide
SMMT	Society of Motor Manufacturers and Traders (United Kingdom)
SPMEPCI	Scheme to Promote Manufacturing of Electric Passenger Cars in India
STEPS	Stated Policies Scenario

SUV	sport utility vehicle
TCO	total cost of ownership
TRY	Turkish lira
USD	United States dollar
VAT	value-added tax
VAMA	Vietnam Automobile Manufacturers' Association
ZEBRA	Zero Emission Bus Regional Areas (United Kingdom)
ZEV	zero-emissions vehicle

## Units of measure

°C	degree Celsius
bbl	barrel
bbl/d	barrels per day
g/km	gram per kilometre
GJ	gigajoule
GW	gigawatt
GWh	gigawatt hour
h	hour
kg	kilogramme
km	kilometre
km/day	kilometre per day
km/h	kilometre per hour
km/lge	kilometre per litre gasoline equivalent
kW	kilowatt
kWh	kilowatt hour
L	litre
m	metre
mb/d	million barrels per day
min	minute
MJ	megajoule
Mt	megatonne
MW	megawatt
MWh	megawatt hour
s	second
t	tonne
t CO <sub>2</sub>	tonne of carbon dioxide
t CO <sub>2</sub> /km	tonne of carbon dioxide per kilometre
TWh	terawatt hour
V	volt
Wh	watt-hour
Wh/kg	watt-hour per kilogramme
Wh/L	watt-hour per litre
yr	year

See the [IEA glossary](#) for a further explanation of many of the terms used in this report.

## Currency conversion

Market exchange rates (2025)	1 US dollar (USD) equals:
British pound sterling	0.78
Canadian dollar	1.43
Chinese yuan renminbi	7.27
Euro	0.93
Korean won	1457.59
New Zealand dollar	1.78
Indian rupee	87.09
Thai baht	34.84
Japanese yen	149.17
Malaysian ringgit	4.63

## Regional groupings

**Advanced economies:** Australia, Austria, Belgium, Bulgaria, Canada, Chile, Colombia, Costa Rica, Croatia, Cyprus,<sup>47,48</sup> Czech Republic, Denmark, Estonia, Finland, France, Germany, Greece, Hungary, Iceland, Ireland, Israel,<sup>49</sup> Italy, Japan, Korea, Latvia, Lithuania, Luxembourg, Malta, Mexico, Netherlands, New Zealand, Norway, Poland, Portugal, Romania, Slovak Republic, Slovenia, Spain, Sweden, Switzerland, Türkiye, United Kingdom and United States.

**Africa:** Algeria, Angola, Benin, Botswana, Cameroon, Côte d'Ivoire, Democratic Republic of the Congo, Egypt, Equatorial Guinea, Eritrea, Ethiopia, Gabon, Ghana, Kenya, Kingdom of Eswatini, Libya, Madagascar, Mauritius, Morocco, Mozambique, Namibia, Niger, Nigeria, Republic of the Congo (Congo), Rwanda, Senegal, South Africa, South Sudan, Sudan, United Republic of Tanzania

<sup>47</sup> Note by Republic of Türkiye: The information in this document with reference to "Cyprus" relates to the southern part of the island. There is no single authority representing both Turkish and Greek Cypriot people on the island. Türkiye recognises the Turkish Republic of Northern Cyprus (TRNC). Until a lasting and equitable solution is found within the context of the United Nations, Türkiye shall preserve its position concerning the "Cyprus issue".

<sup>48</sup> Note by all the European Union Member States of the OECD and the European Union: The Republic of Cyprus is recognised by all members of the United Nations with the exception of Türkiye. The information in this document relates to the area under the effective control of the Government of the Republic of Cyprus.

<sup>49</sup> The statistical data for Israel are supplied by and under the responsibility of the relevant Israeli authorities. The use of such data by the OECD and/or the IEA is without prejudice to the status of the Golan Heights, East Jerusalem and Israeli settlements in the West Bank under the terms of international law.

(Tanzania), Togo, Tunisia, Uganda, Zambia, Zimbabwe and other African countries and territories.<sup>50</sup>

**Asia Pacific excluding China:** Southeast Asia regional grouping and Australia, Bangladesh, Democratic People's Republic of Korea (North Korea), India, Japan, Korea, Mongolia, Nepal, New Zealand, Pakistan, Sri Lanka, Chinese Taipei, and other Asia Pacific countries and territories.<sup>51</sup>

**Caspian:** Armenia, Azerbaijan, Georgia, Kazakhstan, Kyrgyzstan, Tajikistan, Turkmenistan, Uzbekistan.

**Central and South America:** Argentina, Plurinational State of Bolivia (Bolivia), Bolivarian Republic of Venezuela (Venezuela), Brazil, Chile, Colombia, Costa Rica, Cuba, Curaçao, Dominican Republic, Ecuador, El Salvador, Guatemala, Guyana, Haiti, Honduras, Jamaica, Nicaragua, Panama, Paraguay, Peru, Suriname, Trinidad and Tobago, Uruguay and other Central and South American countries and territories.<sup>52</sup>

**China:** Includes (The People's Republic of) China and Hong Kong, China.

**Emerging market and developing economies:** All other countries not included in the advanced economies regional grouping.

**Eurasia:** Armenia, Azerbaijan, Georgia, Kazakhstan, Kyrgyzstan, the Russian Federation (Russia), Tajikistan, Turkmenistan and Uzbekistan.

**Europe:** European Union regional grouping and Albania, Belarus, Bosnia and Herzegovina, Gibraltar, Iceland, Israel,<sup>48</sup> Kosovo, Montenegro, North Macedonia, Norway, Republic of Moldova, Serbia, Switzerland, Türkiye, Ukraine and United Kingdom.

**European Union:** Austria, Belgium, Bulgaria, Croatia, Cyprus,<sup>46,47</sup> Czech Republic, Denmark, Estonia, Finland, France, Germany, Greece, Hungary, Ireland, Italy, Latvia, Lithuania, Luxembourg, Malta, Netherlands, Poland, Portugal, Romania, Slovak Republic, Slovenia, Spain and Sweden.

---

<sup>50</sup> Individual data are not available and are estimated in aggregate for: Burkina Faso, Burundi, Cabo Verde, Central African Republic, Chad, Comoros, Djibouti, Gambia, Guinea, Guinea-Bissau, Lesotho, Liberia, Malawi, Mali, Mauritania, Sao Tome and Principe, Seychelles, Sierra Leone and Somalia.

<sup>51</sup> Individual data are not available and are estimated in aggregate for: Afghanistan, Bhutan, Cook Islands, Fiji, French Polynesia, Kiribati, Macau (China), Maldives, New Caledonia, Palau, Papua New Guinea, Samoa, Solomon Islands, Timor-Leste, Tonga and Vanuatu.

<sup>52</sup> Individual data are not available and are estimated in aggregate for: Anguilla, Antigua and Barbuda, Aruba, Bahamas, Barbados, Belize, Bermuda, Bonaire, Sint Eustatius and Saba, British Virgin Islands, Cayman Islands, Dominica, Falkland Islands (Malvinas), Grenada, Montserrat, Saint Kitts and Nevis, Saint Lucia, Saint Pierre and Miquelon, Saint Vincent and Grenadines, Saint Maarten (Dutch part), Turks and Caicos Islands.

**Latin America:** Central and South America regional grouping and Mexico.

**Middle East:** Bahrain, Islamic Republic of Iran (Iran), Iraq, Jordan, Kuwait, Lebanon, Oman, Qatar, Saudi Arabia, Syrian Arab Republic (Syria), United Arab Emirates and Yemen.

**North Africa:** Algeria, Egypt, Libya, Morocco and Tunisia.

**Other Africa:** Angola, Benin, Botswana, Burkina Faso, Burundi, Cabo Verde, Chad, Côte d'Ivoire, Djibouti, Cameroon, Central African Republic, Democratic Republic of the Congo, Comoros, Eritrea, Ethiopia, Equatorial Guinea, Gabon, Gambia, Ghana, Guinea, Guinea-Bissau, Kenya, Kingdom of Eswatini, Lesotho, Liberia, Madagascar, Malawi, Mali, Mauritania, Mauritius, Mozambique, Namibia, Niger, Nigeria, Republic of the Congo (Congo), Rwanda, Sao Tome and Principe, Senegal, Seychelles, Sierra Leone, Somalia, South Sudan, Sudan, United Republic of Tanzania (Tanzania), Togo, Uganda, Zambia and Zimbabwe.

**North America:** Canada, Mexico and United States.

**Southeast Asia:** Brunei Darussalam, Cambodia, Indonesia, Lao People's Democratic Republic (Lao PDR), Malaysia, Myanmar, Philippines, Singapore, Thailand and Viet Nam. These countries are all members of the Association of Southeast Asian Nations (ASEAN).<sup>53</sup>

---

<sup>53</sup> Timor-Leste joined ASEAN on 26 October 2025 and is excluded from this grouping for this publication, but is included in aggregate within the overarching Asia Pacific excluding China group.

International Energy Agency (IEA).

This work reflects the views of the IEA Secretariat but does not necessarily reflect those of the IEA's individual Member countries or of any particular funder or collaborator. The work does not constitute professional advice on any specific issue or situation. The IEA makes no representation or warranty, express or implied, in respect of the work's contents (including its completeness or accuracy) and shall not be responsible for any use of, or reliance on, the work.



Subject to the IEA's [Notice for CC-licensed Content](#), this work is licenced under a [Creative Commons Attribution 4.0 International Licence](#).

This document, as well as any data and map included herein, are without prejudice to the status of or sovereignty over any territory, to the delimitation of international frontiers and boundaries and to the name of any territory, city or area. Unless otherwise indicated, all material presented in figures and tables is derived from IEA data and analysis.

IEA Publications International Energy Agency Website: [www.iea.org](http://www.iea.org)  
Contact information: [www.iea.org/contact](http://www.iea.org/contact)

Typeset in France by IEA - May 2026  
Cover design: IEA  
Photo credits: © GettyImages

Revised version, June 2025.  
Information notice found at: [www.iea.org/corrections](http://www.iea.org/corrections)

